

Rittal – The System.

Faster – better – everywhere.

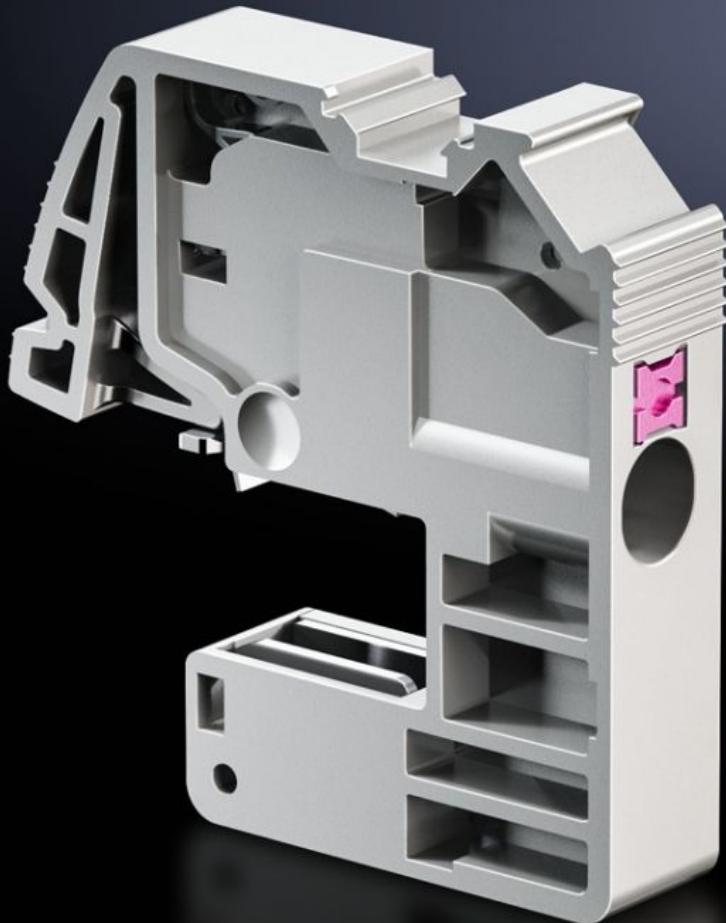

SV 3455.505

Conductor connection clamp

State: 26.09.2024. (Source: [rittal.com/hr-hr](https://www.rittal.com/hr-hr))

ENCLOSURES

POWER DISTRIBUTION

CLIMATE CONTROL

IT INFRASTRUCTURE

SOFTWARE & SERVICES

FRIEDHELM LOH GROUP



SV 3455.505 - Conductor connection clamp Push-in

For the connection of round conductors.

Features

Model No.	SV 3455.505
Benefits	Maintenance-free Time-saving top-mounting Terminal box with integral label panels Universal conductor connection
Applications	For use as busbar pick-off of L, N or PE conductors in switchgear and controlgear, and as a conductor connection clamp in meter boxes. For mounting on E-Cu or CUPONAL busbars
Function principle	Fully insulated terminal for tool-free conductor connection Conductor is released by the integral release pin
Material	Polyamide Fire protection corresponding to UL 94-V0
Colour	RAL 7042
Test specification	IEC 60 999-1 IEC 60 947-7-1/-2
Connection of round conductors, fine wire with wire end ferrule	0.5 - 4 mm ²
Connection of round conductors, fine wire without wire end ferrule	0.5 - 4 mm ²
Connection of round conductors, multi-wire	0.5 - 4 mm ²
Connection of round conductors, single-wire	0.5 - 6 mm ²
For bar thickness	10 mm
Packs of	10 pc(s).
Weight/pack	0,13 kg

Features

Net weight	0.12
Gross weight	0.132
PCF/PU (Cradle-to-Gate)	0.5 kg CO2 eq (Cat B)
Note on the PCF class	Category B: PCF value (cradle-to-gate) approximated based on product weight and self-declared
Customs tariff number	85369010
EAN	4028177813984
ETIM 8	EC000001
ETIM 7.0	EC000001
ECLASS 8.0	27141146

Approvals

Approvals	ABS Lloyds Register of Shipping UR + C-UR (recognized)
Explanations	Declaration of conformity