

Rittal – The System.

Faster – better – everywhere.

Technical System Catalogue

Cooling with ambient air



ENCLOSURES

POWER DISTRIBUTION

CLIMATE CONTROL

IT INFRASTRUCTURE

SOFTWARE & SERVICES

FRIEDHELM LOH GROUP



How do I find the optimum climate control solution?



When it comes to the successful implementation of complex production processes, the high-quality, sensitive components housed in enclosures play a vital role. Effective climate control is highly relevant to the service life of these components. But how do you decide which climate control method is best for your system?

To find the optimum climate control solution, it is important to undertake a thorough analysis and consider the available options as a whole. There are various options to choose from, such as using liquid cooling with air/water heat exchangers, using the ambient air or using an enclosure heater. You should also consider the local environment. Is it damp, dusty or hot?

Additionally, the precise cooling output requirements play a decisive role. Additional factors such as the type of siting (free-standing or integrated), the type of heat dissipation (passive or active) and the acceptable noise level should likewise be taken into account.

Note:



Did you know that optimum climate control can considerably lengthen the service life of your enclosure components?

As the packing density in enclosures rises, so too does the heat loss.

A useful rule of thumb states that a 10 °C rise in the operating temperature will cut the service life in half and double the rate of failure.

Typical faults caused by the wrong climate control:



- In 64% of assemblies, the hot components had not been positioned directly in the airflow between the climate control unit's outlet and inlet.
- 50% of monitored devices had a capacity utilisation of less than 20%.
- 93% of assemblies had failed to plan for or install targeted air routing.
- 40% of devices had heavily contaminated filter mats and were inadequately maintained.
- In 18% of assemblies, the climate control unit's outlet or inlet was obstructed.
- 19% of assemblies had air short-circuits.



Rittal undertook a comprehensive field study of around 400 industrial installations to discover how climate control solutions are typically implemented in practice. We identified countless errors which could have been avoided with optimum planning and by using the correct tools.

Our free planning tool RiTherm can help you plan the ultimate climate control for your enclosure – see page 59

Careful planning is vital to ensure that efficient climate control solutions deliver maximum performance with minimum energy consumption. This is where RiTherm can help you develop your ultimate climate control solution.

Sustainability is our priority. Yours too?

10 x higher CO₂ savings
in the year of operation than
is generated in production



Average **75%**
energy savings
per Blue e+ unit

Savings of 2,100 kWh per
year with every Blue e+ device

Sustainability ranks alongside digitalisation at the very top of the global agenda. Companies today face unprecedented challenges. They need to find solutions that will harmonise political requirements with rising electricity prices and a growing demand for energy.

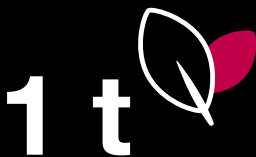

saving

per unit, per year –
equivalent to the **CO₂**
absorbed by one
beech tree over **80 years**

Modern machines and switchgear must meet industry requirements. They must be standardised, digitally linkable, powerful and safe. At the same time, a minimal carbon footprint from production and sustainable siting are increasingly important. It is essential to look to the future and invest intelligently in technologies and climate protection that can help you achieve and build on long-term financial success.

In one year of operation, Blue e+ cooling units can save ten times the amount of carbon released during production. Over their life span, they will save substantially more CO₂ than was released during their production.

Sustainability is a key consideration with the Blue e+ fan-and-filter units. Superior motor efficiency means that the EC models consume up to 60 percent less energy. The pleated fan (included with the supply) reduces the fan operating hours by a further 22 percent. As well as conserving resources, this is also beneficial for your wallet.

Cooling units and fan-and-filter units in the Blue e+ generation are synonymous with innovative technologies that are both powerful and sustainable. By choosing these products, you can make a positive contribution to climate protection and reinforce your company's commitment to green solutions.

Now is the time to take action. We're ready. Are you?



Sustainability:

■ Rail technology

The 1 t of carbon saved with every unit equates to an 80,000 kilometre rail journey (for one passenger)

■ Mechanical engineering

The 1 t of carbon saved with every unit equates to a diesel-powered forklift truck operating for 60 hours

Rittal – The System.

Faster – better – everywhere.



Cooling with ambient air

Even in apparently non-critical ambient conditions, for example when there is an adequate supply of clean, cool air, it is still worthwhile to provide climate control. Here too, the aim is to achieve maximum reliability with exceptional efficiency. Reliability and efficiency with fan-and-filter units: Temperature-dependent speed control plus temperature and airflow monitoring.

Reliability and efficiency with air/air heat exchangers: Thanks to separate air circuits (external/internal), dust and contaminants are kept outside the enclosure, while a micro-controller provides temperature-dependent control and monitoring of key parameters. The benefit to you: Efficient reliability at all times.



Blue e+ fan-and-filter unit

Fan-and-filter units are ideal for dissipating heat loads cost-effectively. The pre-requisite is that the ambient air must be clean and at a temperature below the required enclosure internal temperature.

The EC version delivers exceptional energy efficiency plus flexible interfaces for smart control and monitoring.

Additionally, EC fan-and-filter units have an emergency cooling function to deliver additional cooling output at hotspots.



Roof-mounted fans/ roof vent

Powerful radial fans ensure effective heat dissipation. The flexible mounting concept boasts impressive accessibility.



IT roof-mounted fans/ IT fan modules

IT roof-mounted fans for the office sector cool network racks with minimal noise generation.



Rack-mounted fans/ tangential fans

Rack-mounted climate control components are fitted directly onto the 482.6 mm (19") mounting level.

Positioning directly beneath the electronic components ensures effective ventilation, and prevents the formation of hotspots.



Air/air heat exchangers

The requirement for using air/air heat exchangers is that the ambient temperature must be below the required enclosure internal temperature.

Dust and contaminated ambient air is unable to ingress the enclosure, thanks to the two separate air circuits.

Fan-and-filter units – the latest Blue e+ generation

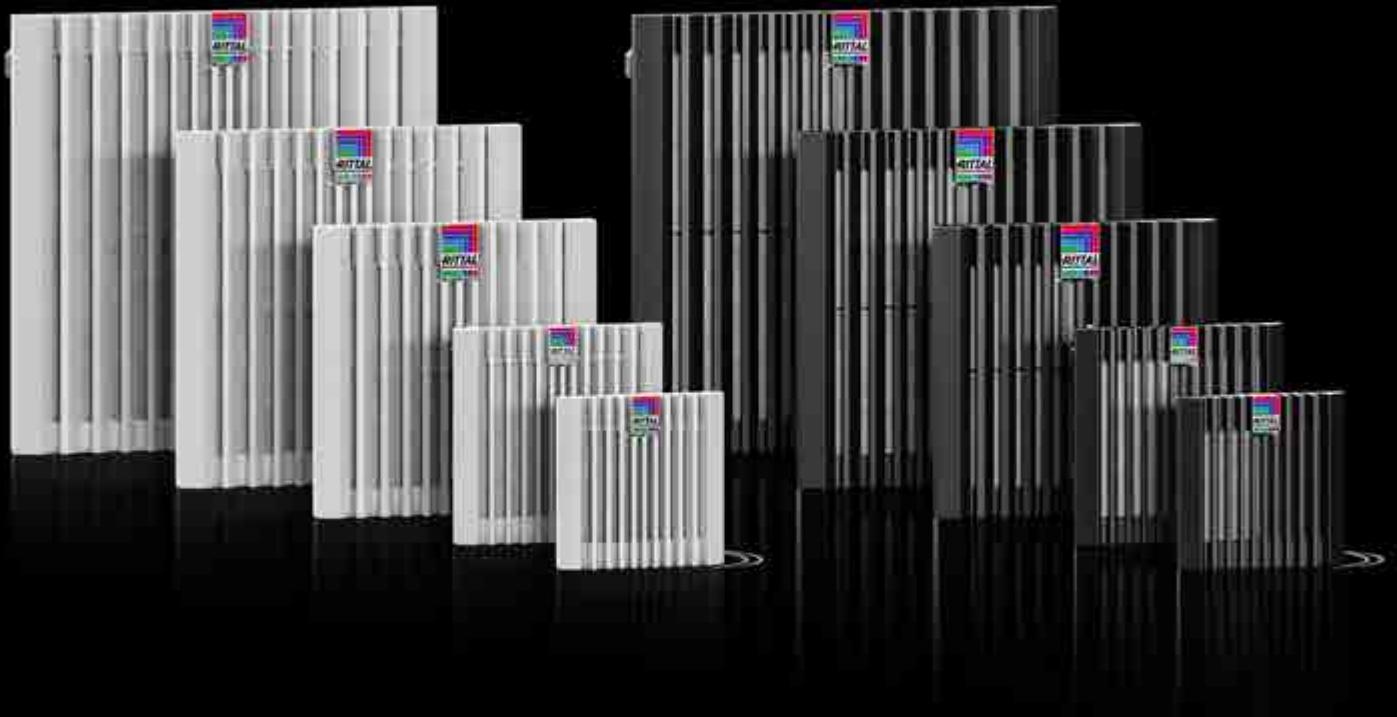

Fan-and-filter units are ideal for dissipating heat loads cost-effectively. The prerequisite is that the ambient air must be relatively clean with a temperature below the desired enclosure internal temperature. The fan-and-filter range is available in AC/DC and EC variants and with EMC shielding. As well as efficiency and multi-voltage capabilities, the Blue e+ fan-and-filter units with EC technology also boast exclusive IoT features.

Benefits at a glance:

- 5 sizes and 8 output categories
- Air throughput from 20 m³/h to 1160 m³/h
- The pleated filter (included with the supply) enables a higher air throughput
- EC variant available from 175 m³/h
- IP 54 as standard (up to 855 m³/h)
- Available in RAL 7035 and RAL 9005

Note:

The mounting cut-outs for the TopTherm fan-and-filter generation remain unchanged and are easily exchanged at any time! However, please note the installation depth of the fan-and-filter unit.

Blue e+ fan-and-filter units

Tried-and-trusted features retained

Homogeneous air distribution inside the enclosure

- The diagonal fan technology achieves more even, constant ventilation of the enclosure with superior pressure stability

Tool-free handling:

- Screwless spring terminal for tool-free electrical connection, bayonet connector for tool-free reversal of the airflow direction

Software tools:

- Simple design using RiTherm and RiPanel

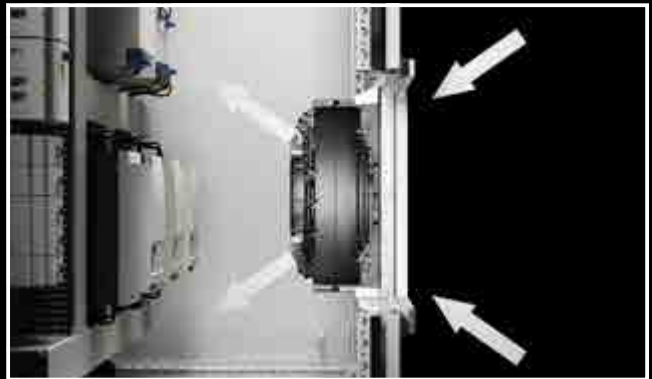

Optimisation of mechanical components

- Improved opening mechanism for simple filter changes
- Improved enclosure mounting, snaps into position more easily
- Seamless design analogous to the vertical louvred grille in the Blue e+ S cooling units

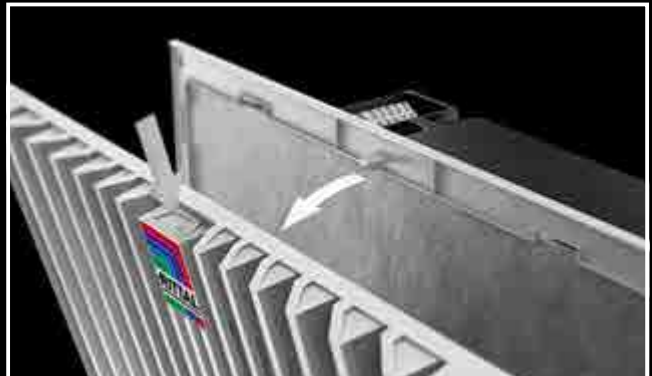

New filter technology with pleated filter (included with the supply)

Higher air throughput

- Reduced pressure build-up allows the fan to move 40% more air (average figure). This helps to cut operating hours, which in turn reduces energy and electricity costs.

Superior filter properties

- In particular, finer dust particles (0.3 – 1 µm) are removed far more efficiently. 50% better separation performance means less dust in the enclosure.

Longer filter service life

- 2 – 3 times longer service life saves time and money

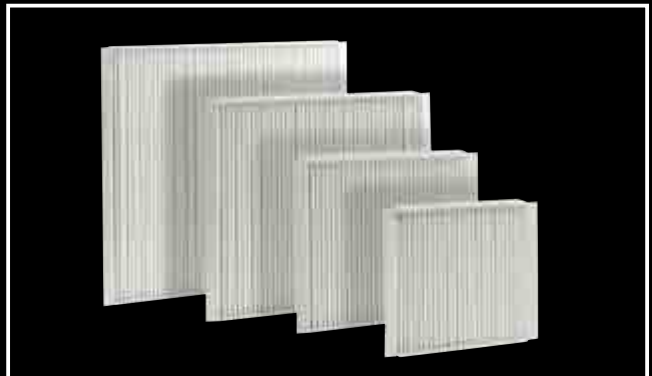

Blue e+ fan-and-filter units with EC technology

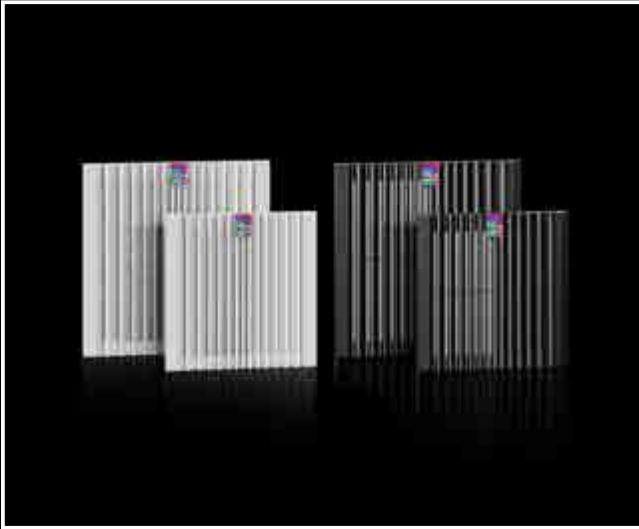

More power for your enclosure cooling

60% energy savings

- Thanks to the efficient motor

Alarm relay for added peace of mind

- Malfunctions are notified immediately

Flexibility

- Connection voltage from 100 – 240 V, 1~, 50/60 Hz supports global use

Simple monitoring

- Control and monitoring via analog or digital interfaces



Impressive IoT features

Predictive maintenance



The running time and speed of the EC motor are continuously recorded. Like the fuel display in a car, the Rittal IoT interface tells you when the next filter change is due. This helps to reduce your servicing costs.

Filter cleaning

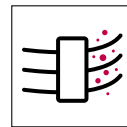

Automatic filter cleaning several times a day. The airflow direction is briefly reversed to “blow out” the filter. Fine dust particles caught in the filter are removed. This extends the filter service life by 20%, which in turn reduces your maintenance costs.

Emergency cooling function

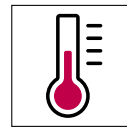

Excessively high temperatures inside the enclosure can lead to system failure. The emergency cooling function of the EC fan-and-filter unit responds actively to avert such problems. As soon as the temperature exceeds the defined alarm threshold value, the fan speed is increased to its maximum. This releases up to 40% more air throughput and delays or prevents components from overheating.

Blue e+ fan-and-filter units

Greater power & efficiency for your enclosure cooling,
see page 8

40% 

more air throughput
with the **integral**
pleated filter



More information about
Blue e+ fan-and-filter units can be found here:

www.rittal.com/fan-and-filter-units

Blue e+ fan-and-filter unit

Project management

The following applies when calculating the volumetric air flow:

$$\dot{V} = f \cdot \frac{\dot{Q}_V}{\Delta T}$$

Performance diagram SK 3238. . . [50 Hz]

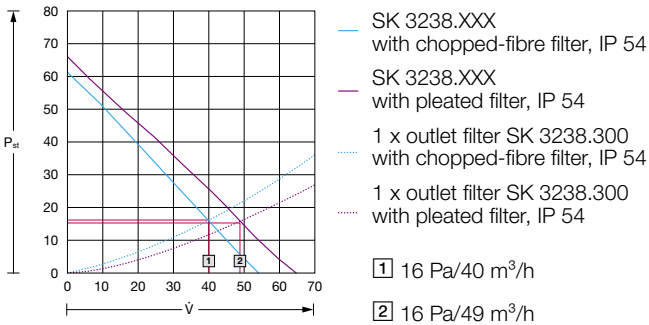

\dot{V} = Volumetric flow (m³/h)
 ΔP_{st} = Stat. pressure difference (Pa)

Performance diagram SK 3245. . . [50 Hz]

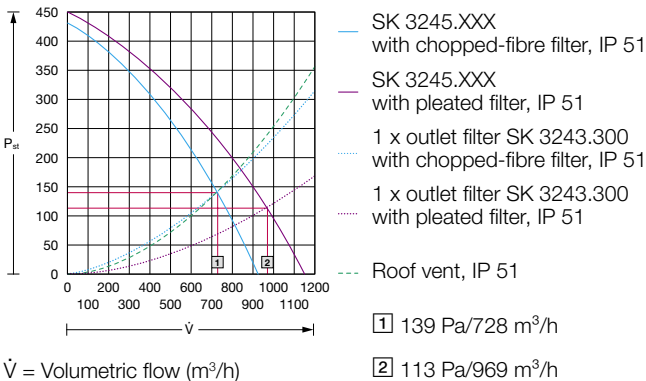

\dot{V} = Volumetric flow (m³/h)
 ΔP_{st} = Stat. pressure difference (Pa)

Further performance diagrams may be found on the Internet.

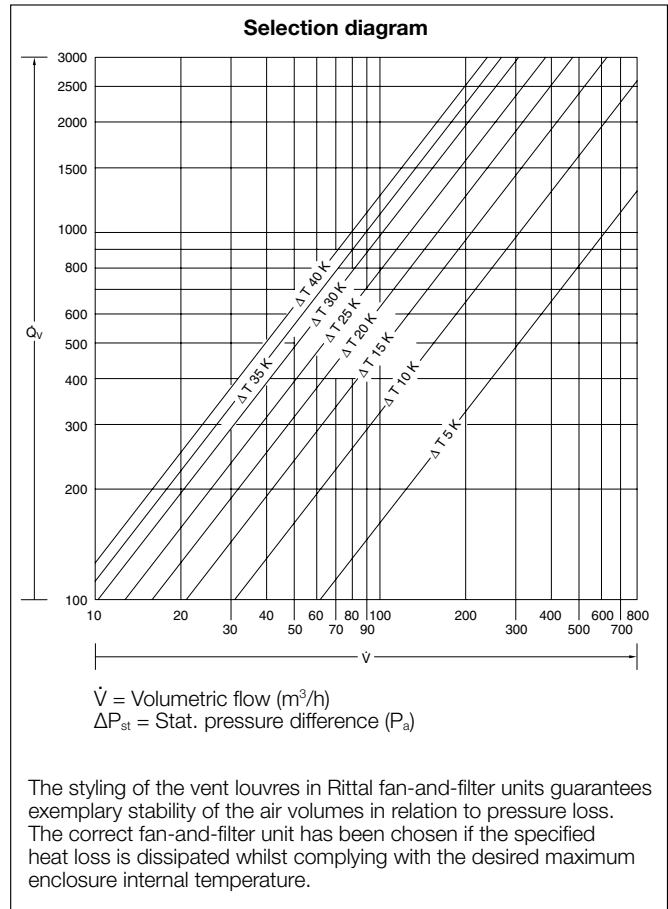

- f = 3.1 m³ · K/Wh at h = (0 to 100)
- f = 3.2 m³ · K/Wh at h = (100 to 250)
- f = 3.3 m³ · K/Wh at h = (250 to 500)
- f = 3.4 m³ · K/Wh at h = (500 to 750)
- f = 3.5 m³ · K/Wh at h = (750 to 1000)
- f = Compensating factor
- h = Height above sea level [m]

Calculation basis for enclosure climate control

In natural convection, heat loss is dissipated to the outside via the enclosure panels. The prerequisite for this is that the ambient temperature must be lower than the temperature inside the enclosure. The maximum temperature increase ΔT_{\max} , which may occur inside an enclosure compared with the ambient air is calculated as follows:

$$(\Delta T)_{\max} = \frac{\dot{Q}_v}{k \cdot A}$$

Note:

If the heat loss inside the enclosure is not known, this basic formula can be used to calculate actual heat loss, by measuring the ambient temperature T_u and the enclosure internal temperature T_i .

$$\dot{Q}_s = A \cdot k \cdot \Delta T \text{ (watts)}$$

\dot{Q}_v	= Heat loss installed in the enclosure [W]
\dot{Q}_s	= Heat emitted by the enclosure surface [W] $\dot{Q}_s > 0$: Radiation ($T_i > T_u$) $\dot{Q}_s < 0$: Irradiation ($T_i < T_u$)
\dot{Q}_E	= Required cooling output of an enclosure cooling unit [W]
\dot{Q}_H	= Required thermal output of an enclosure heater [W]
q_w	= Specific thermal output of a heat exchanger [W/K]
\dot{V}	= Required volumetric air flow of a fan-and-filter unit to maintain the maximum permissible temperature difference between the supply air and the exhaust air [m^3/h]
ΔT	= $T_i - T_u$ = Max. permissible temperature difference [K]
A	= Effective, heat loss-dissipating enclosure surface area to IEC 890 [m^2]
k	= Heat transfer coefficient [W/m^2K] for sheet steel $k = 5.5 W/m^2K$



Blue e+ fan-and-filter unit

Blue e+ EMC fan-and-filter units

- For superior EMC shielding/attenuation
- Durable copper-nickel-chrome plated filter housing and filter mat
- Identical filter class to standard filters
- Chopped fibre mat with progressive structure and copper-nickel-chrome plating

Caution: Shielding/attenuation is only guaranteed if using the original EMC filter mat!

Applied test standard:

EN 61587-3:2013

Shielding attenuation tests for enclosures, racks and subracks

This part of EN 61587 defines the testing of shielding attenuation with empty enclosures and subracks within the frequency range from 30 MHz to 2000 MHz.

The purpose of this standard is to ensure the physical intactness and environmental behaviour of enclosures while allowing for differing requirement levels in different applications.

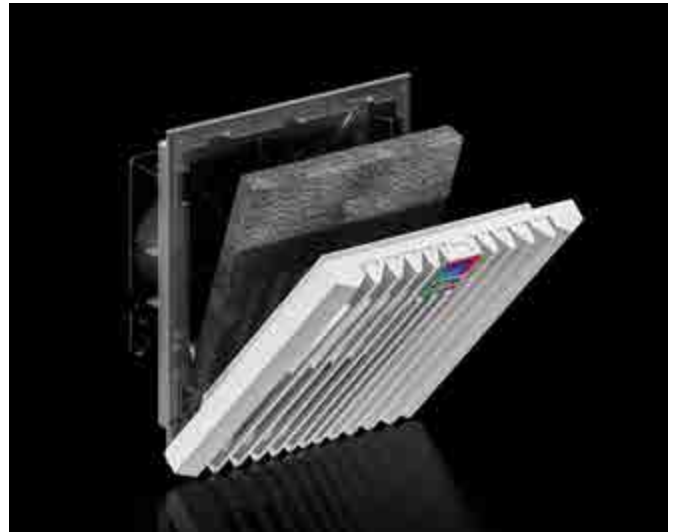

Attenuation levels to EN 61587-3:2013

Requirement level	Frequency range	Frequency range
	230 MHz to 1000 MHz	1000 MHz to 2000 MHz
1	10 dB	0
2	30 dB	20 dB
3	50 dB	40 dB

Electromagnetic shielding to IEC 61000-5-7

Requirement level 1 for EM code is: EMxxx210x

Requirement level 2 for EM code is: EMxxx430x

Requirement level 3 for EM code is: EMxxx650x

Shielding/attenuation diagram (to EN 61587)

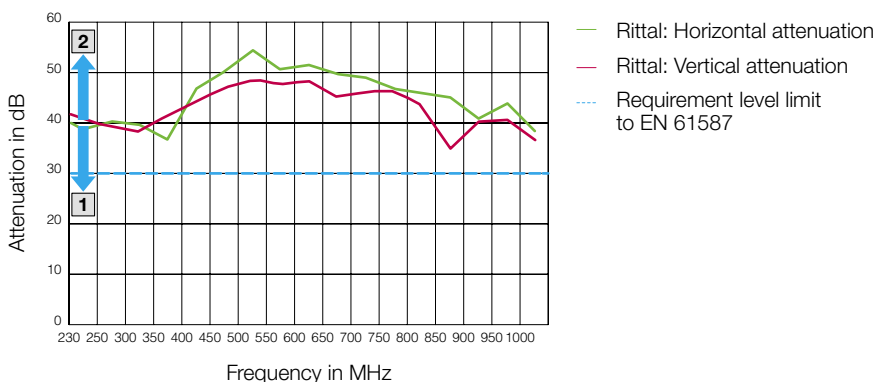

Blue e+ fan-and-filter units

Enter the future of fan-and-filter technology with Blue e+ fan-and-filter units. Alongside their pioneering IoT-compatibility, their outstanding filter performance with innovative pleated filter as standard sets these units apart. These fan-and-filter units will unlock a host of benefits – from energy efficiency, to superior monitoring and sustainability, and superior filter performance. Rittal boasts the most powerful, sustainable and safest fan-and-filter unit on the market.



More information about Blue e+ fan-and-filter units can be found here:

www.rittal.com/fan-and-filter-units

Roof-mounted fans/roof vent



Ready-to-use, wired modules equipped with radial fans for numerous Rittal enclosure system platforms deliver effective air throughput with minimal assembly work.

Choose from:

- Roof-mounted fan
- Roof vent

Benefits at a glance:

- Passive variant without fan for natural convection
- Air throughput range from 500 – 1,000 m³/h
- At an air throughput of 1,000 m³/h, EC fans ensure maximum energy efficiency
- Just one mounting cut-out for all output categories
- Optimum efficiency, thanks to sophisticated air routing with minimal pressure losses
- Innovative clamping attachment ensures a high protection rating (IP 54)

Roof-mounted fans/ roof vent

Roof-mounted fan

Simple to fit and maintain

- Innovative clamping attachment supports flexible installation and removal from either the outside or inside
- Connector terminal for easy electrical connection
- Good accessibility permits fast filter mat changes

High protection category

- IP 54 as standard, thanks to a sophisticated labyrinth system and high-quality foamed-in seal
- International approvals and permits

- The high-quality pleated filter technology permits a significant increase in the volumetric air flow compared to conventional chopped-fibre filter mats. Cooling unit performance is improved and energy consumption is lower. The enhanced filtration properties also mean less dust in the enclosure or unit, and the resulting longer maintenance intervals reduce service costs significantly.

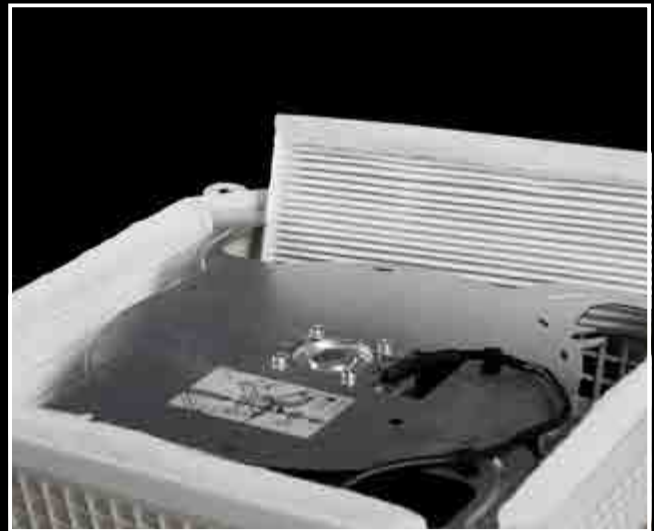

Roof vent

The roof vent is used for passive heat dissipation without the use of a fan. Nevertheless, it offers the same installation benefits and protection category as roof-mounted fans.



IT roof-mounted fans/fan modules

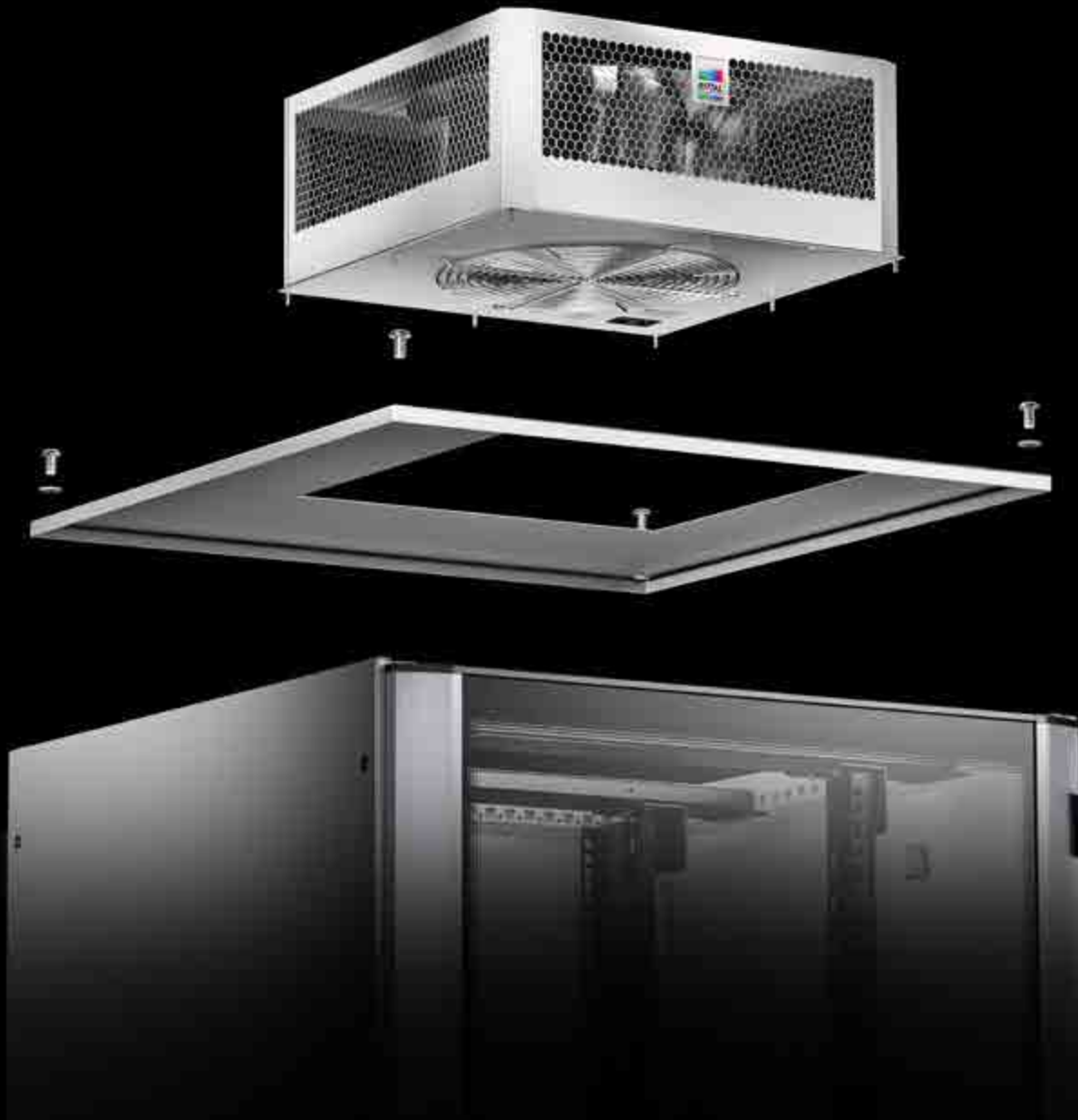

Shhhh. IT technology in the office sector demands extensive performance, assembly and cost benefits, as well as reducing noise levels. Our range of small cooling units includes roof-mounted ventilation concepts which are ideal for use in sensitive office areas, thanks to their huge volumetric flow and minimal noise generation. These solutions can be used to cool network enclosures in closed rooms, data centres and large telecommunications systems.

IT roof-mounted fans for VX IT, TS IT Benefits at a glance:

- Low noise generation of just 39 dB (A)
- High volumetric flow ranging from 1245 to 1345 m³/h (unimpeded airflow)
- Available in RAL 9005 and RAL 7035

IT fan module for VX IT, TS IT, TX CableNet Benefits at a glance:

- The unit may be optionally extended with additional fans
- Simple connection system
- Energy-efficient speed control

IT roof-mounted fans/ fan modules

IT roof-mounted fan with a high volumetric flow from 1245 to 1345 m³/h (unimpeded airflow)

Energy-efficient with integral speed control

- The speed increases depending on the intake temperature based on a fixed resistance curve. Speed controllers may be removed and replaced with a thermostat. On/off function with adjustable threshold value.

Operation

- Suitable for use in offices, thanks to the minimal noise generation of just 39 dB (A)

International

- Suitable for global use, thanks to wide-range voltage capabilities and international approvals

Simple connection system

- Device with C13 IEC 320 socket

Backward-compatible

- Matches the cut-outs of the predecessor model



IT fan modules 400 m³/h (unimpeded airflow)¹⁾

Energy-efficient with integral speed control

- The speed increases depending on the intake temperature based on a fixed resistance curve. Speed controllers may be removed and replaced with a thermostat. On/off function with adjustable threshold value.

International

- Suitable for global use, thanks to wide-range voltage capabilities and international approvals

Simple connection system

- Device with C13 IEC 320 socket

Backward-compatible

- Matches the cut-outs of the predecessor model

¹⁾ With 6 fans max. 1150 m³/h (unimpeded airflow)



Fan expansion kit

- For use as a stand-alone fan, and for upgrading various fan units or to supplement the fan mounting plate



IT roof-mounted fans/fan modules

Project planning and selection criteria

Volumetric airflow with multiple fans

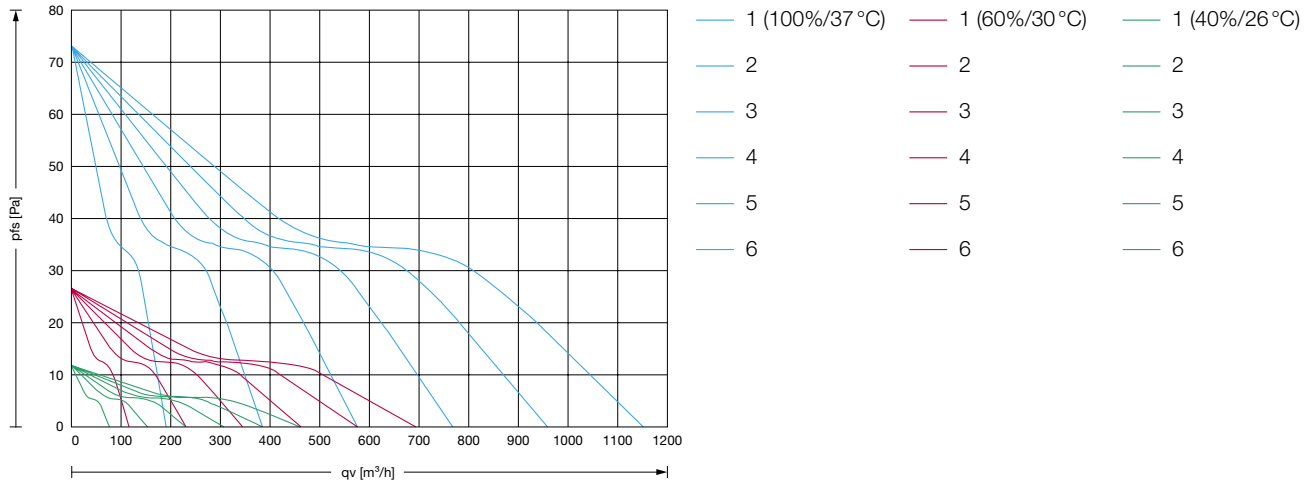

pfs [Pa] = Back-pressure
 qv [m³/h] = Air volume

Noise level with multiple fans and different speeds

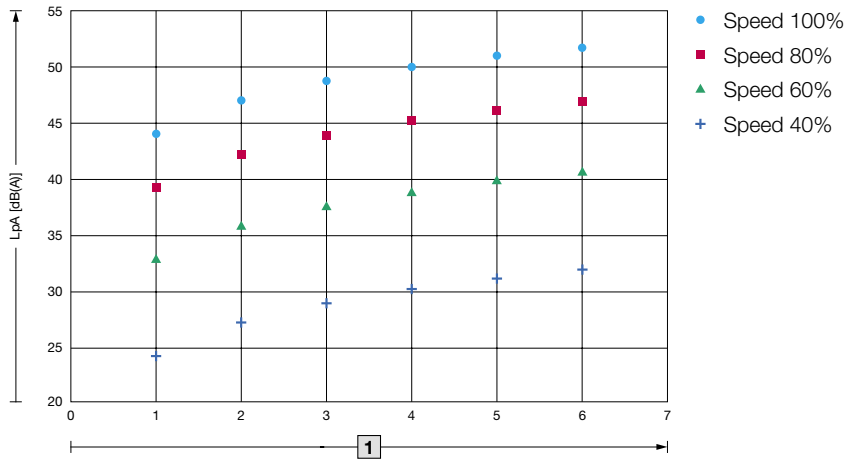

LpA [dB(A)] = Sound pressure

1 No. of fans 1 – 6

Industrial Internet of Things

Fast, uninterrupted, automated production,
see page 57



Rack-mounted fans/tangential fans



All rack-mounted climate control components are fitted directly onto the 482.6 mm (19") mounting level for subracks. Positioning directly beneath the electronic components ensures effective cooling, and prevents the formation of hot-spots.

Benefits at a glance:

- Rapid installation on 482.6 mm (19") mounting levels
- Direct, effective dissipation of heat loss, thanks to positioning beneath the assemblies
- No externally mounted equipment to disrupt the aesthetic appearance of the enclosure

Rack-mounted fans/ tangential fans

Rack-mounted fans

- The rack-mounted fan slides into the guide frame like a drawer. Connectors on the rear ensure immediate contact.
- Installation options for the guide frame: Directly in the subrack, via two mounting brackets on the 482.6 mm (19") mounting angles.
- Ideal for avoiding hotspots in fully populated enclosures
- Also available with speed monitoring of the fans. A reduction in air flow or fan failure being signalled via two floating contacts.



Tangential fans

- 320 m³/h air throughput, 2 U: The high air throughput means that Rittal tangential fans are capable of dissipating large heat losses from the enclosure. The minimal noise generation of 52 dB creates a pleasant working environment.



Air/air heat exchangers



The requirement for using air/air heat exchangers is that the ambient temperature must be below the required enclosure internal temperature. Dust and any aggressive ambient air is unable to ingress the enclosure, thanks to the two separate air circuits.

Benefits at a glance:

- Specific thermal output from 17.5 W/K to 90 W/K
- Mounting cut-outs and enclosure dimensions identical to Blue e wall-mounted cooling units
- Suitable for external and internal mounting
- Top design identical to Blue e wall-mounted cooling units

Important:

The temperature difference between the room temperature and enclosure internal temperature will have a decisive effect on the heat loss that may be dissipated.

Air/air heat exchangers

High protection

High protection category

- Thanks to the seamlessly sealed heat exchanger module, a protection rating of IP 54 to IEC 60 529 is achieved

High load capacity

- The motors of the fans are equipped with thermal winding protection

Top quality: Guaranteed protection for your electronics

- All devices in the Rittal Blue e series are tested in accordance with the internationally recognised approvals



Intelligent control

- Specific thermal output from 17.5 to 90 W/K
- With controller and digital temperature display
- Floating fault signal contact in case of overtemperature
- System analysis via display



Platform strategy/installation

Identical installation cut-outs

- For various output classes

Easily retrofitted

- Thanks to the low weight, simple cut-outs and ease of installation of the heat exchangers, they may be easily retrofitted to an existing cabinet or enclosure

Simple maintenance

- The heat exchanger module is very easily removed, for effortless cleaning. The cleverly thought-out structure enables fast, economical maintenance.



Air/air heat exchangers

Project planning

Calculate the specific thermal output of the heat exchanger:

$$q_w = \frac{\dot{Q}_v - (A \cdot \Delta T \cdot k)}{\Delta T}$$

Selection diagram

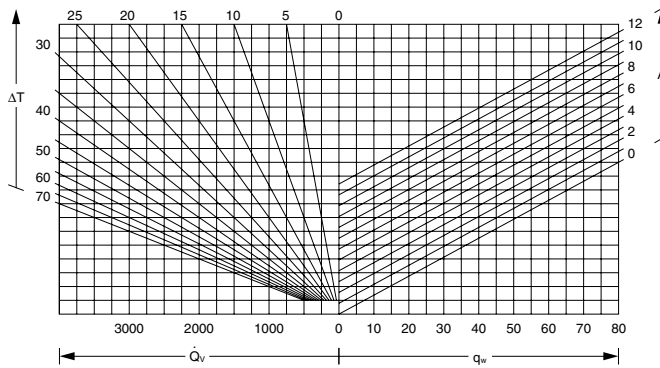

- ΔT = Temperature difference (K)
- \dot{Q}_v = Heat loss (W)
- q_w = Specific thermal output (W/K)
- A = Enclosure surface area to IEC 890 (m²)
- k = Heat transfer coefficient (W/m²K) for sheet steel $k = 5.5$ W/m²K



**Specific thermal output 17.5 – 90 W/K,
wall-mounted with controller**

50/60 Hz

SK 3126.100, 3127.100, 3128.100, 3129.100, 3130.100, 3248.000

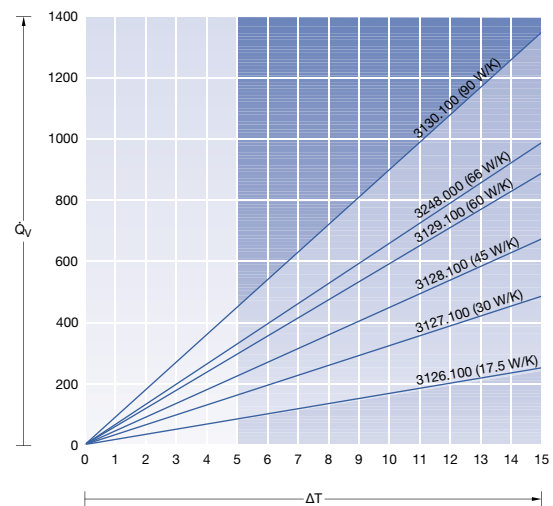

- ΔT = Temperature difference (K)
- \dot{Q}_v = Heat loss (W)

Internal circuit – Wall-mounted units

Attention should be paid to installed equipment that is fitted with its own ventilation system, such as blowers and axial fans. If their air flow is directed against the chilled air flow of the heat exchanger, the air may short-circuit, bypassing the component and adequate climate control would no longer be guaranteed.

Note:

Never direct the chilled air flow at active components.

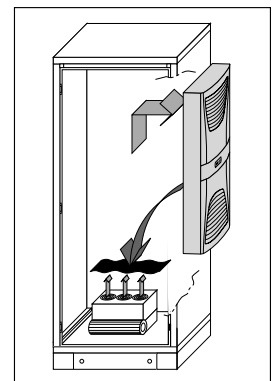
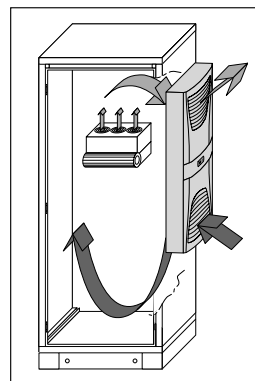

Air/air heat exchangers

External circuit – Flow and siting conditions

Air/air heat exchangers in the external circuit should have a distance of at least 200 mm from a wall and from one another (air inlet and outlet openings). If this distance cannot be met, air baffle plates should be used.

Siting options

Wall-mounted heat exchangers may be mounted on the rear panel, side panels or door of the enclosure.

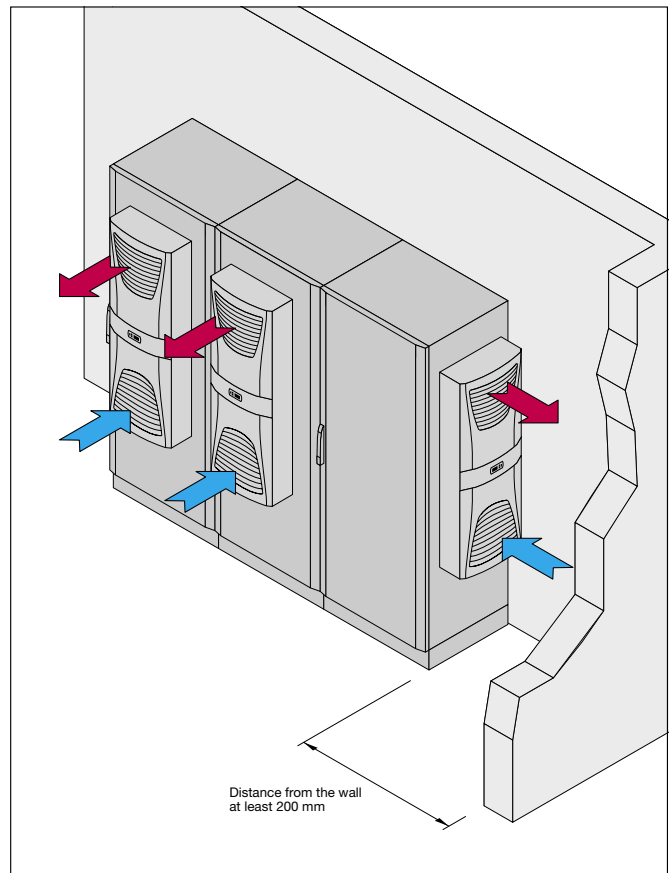

Free air circulation

It is important to ensure “even” air circulation inside the enclosure. Air inlet and outlet openings in the internal circuit must on no account be obstructed by electrical installations. This would prevent air from circulating inside the enclosure. Under such conditions, the capacity of the device would not be adequately utilised. A clearance of > 200 mm must be guaranteed.

Note:

Wall-mounted cooling units should never be fitted directly behind the mounting plate. Active power components are located on the front of the mounting plates. The heat exchanger would then operate in its own air short-circuit.

If it is impossible to install the device any other way, appropriate air baffle plates should be used, and air inlet and outlet openings should be provided in the mounting plate.

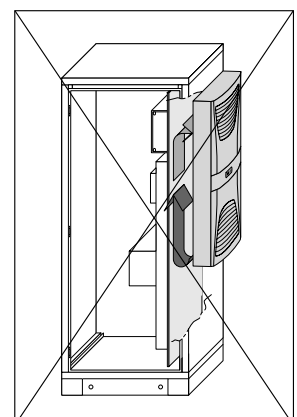
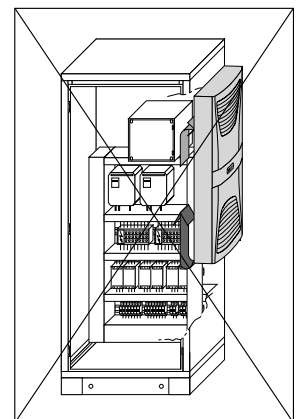
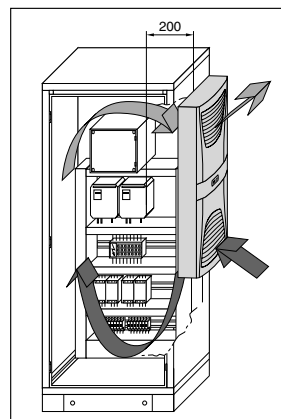

Rittal – The System.

Faster – better – everywhere.



Cooling units

Cooling units keep the temperature of the air inside an enclosure at a constant level, even to below room temperature. Two separate air circuits prevent the ingress of dust or other contaminants into the enclosure.

The most efficient cooling units in the Blue e+ generation in the output range from 300 to 5800 W achieve average energy savings of 75% compared with conventional systems.



Thermoelectric coolers

The powerful, lightweight climate control units based on Peltier technology provide efficient cooling of command panels and small enclosures.



Wall-mounted cooling units

For external mounting or internal mounting in doors and walls using standardised mounting cut-outs. Integrated electric condensate evaporation (from 0.3 kW) Protection ratings: IP 54/IP 55/ IP 56, UL Type 3R/4, 12 and NEMA 4X. Wall-mounted Blue e+ cooling units are available in sheet steel, stainless steel and maritime options as well as chemical and outdoor options.



Roof-mounted cooling units

Chilled air may be routed to satisfy specific cooling requirements using ducts in conjunction with up to four supply air spigots. In the external circuit, the heated air is expelled to the rear, left and right, and optionally upwards allowing the enclosure to be sited in a bayed suite or close to the wall.



Modular climate control concept

With no mounting cut-outs whatsoever, different combination options with different dimensions, cooling outputs and voltages support a wide range of applications.

Cooling units

Project planning

Calculate your required cooling output:

$$\dot{Q}_E = \dot{Q}_V - k \cdot A \cdot \Delta T$$

Condensation and dehumidification of enclosure air when using cooling units

One unavoidable side-effect of using cooling units is the dehumidification of the enclosure's interior air. As it cools down, part of the humidity contained in the air condenses on the evaporator coil. This condensate must be reliably discharged from the enclosure. The amount of condensate occurring depends on relative humidity, the air temperature inside the enclosure and on the evaporator coil, and the air volume present in the enclosure. The Mollier h-x diagram shows the water content of air depending on its temperature and relative air humidity.

Mollier h-x diagram for calculating the water content of air

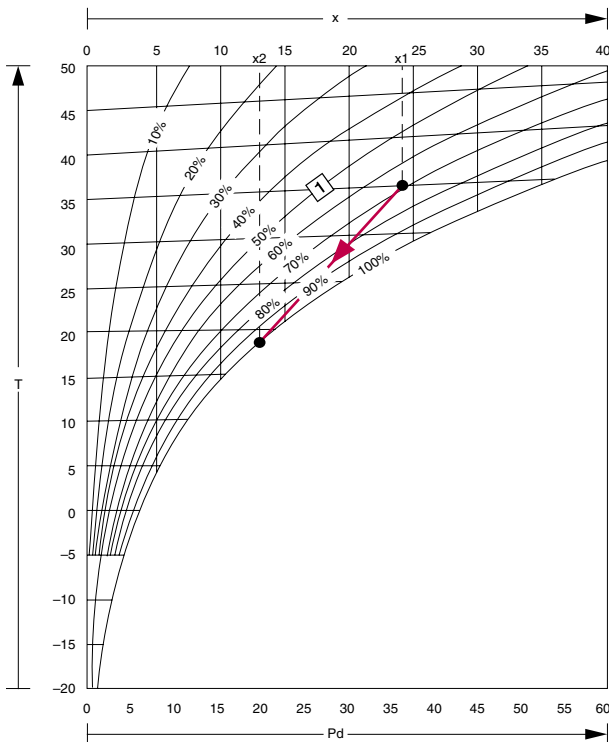

Pd = Water vapour partial pressure (mbar)
 T = Air temperature (°C)
 x = Water content (g/kg dry air)
 □ = Relative humidity

Practical tips

In all situations where optimum operating temperatures are required inside an enclosure, even at high external temperatures, a Rittal enclosure cooling unit can provide the right solution. It is even possible to cool the interior temperature of the enclosure to well below the ambient temperature. The favourable aerodynamic arrangement of the air inlet and outlet openings in the internal and external circuits ensures optimum air circulation inside the enclosure. This sample calculation will show you a quick, time-saving method of selecting a cooling unit.

Example:

A cooling unit with a refrigeration output of 1500 watts commences operation with a temperature setting of $T_i = 35^\circ\text{C}$. The relative ambient air humidity is 70%. If air at 35°C is passed over the evaporator coil, the surface temperature of the evaporator coil (evaporation temperature of the refrigerant) is approximately 18°C . At the boundary layer adhering to the surface of the evaporator coil, water is deposited at the dew point. The difference $\Delta x = x_1 - x_2$ indicates how much condensation is produced per kg of air with complete dehumidification. The leak-tightness of the enclosure has a decisive effect on the quantity of condensation.

The quantity of condensation is calculated from the following equation:

$$W = V \cdot \rho \cdot \Delta x$$

W = Water quantity in g
 V = Volume of enclosure in m^3
 r = Density of air kg/m^3
 Dx = Difference of water content in g/kg dry air (from the Mollier h-x diagram)

Enclosure door closed:

Only the enclosure volume is dehumidified.

$$V = W \cdot H \cdot D = 0.6 \text{ m} \cdot 2 \text{ m} \cdot 0.5 \text{ m}$$

$$V = 0.6 \text{ m}^3$$

$$W = V \cdot r \cdot Dx$$

$$= 0.6 \text{ m}^3 \cdot 1.2 \text{ kg}/\text{m}^3 \cdot 11 \text{ g}/\text{kg}$$

$$W = 7.92 \text{ g} \approx 8 \text{ ml}$$

Poorly sealed cable designs, damaged door seals and the fitting of display media to enclosure surfaces lead to increased rates of leakage in the enclosure. Hence, with a leakage rate of, say, $5 \text{ m}^3/\text{h}$, a continuous condensate volume of up to $80 \text{ ml}/\text{h}$ may occur.

Conclusion:

Enclosure cooling units should only operate with the door closed.

- Seal the enclosure on all sides
- Use a door limit switch
- Only set the enclosure internal temperature as low as is actually needed

Selection criteria

Enclosure climate control poses escalating demands on integration and adaptation to the local conditions and the existing process control and monitoring system.

Rittal offers the right solution to suit every requirement.

When selecting the appropriate cooling unit for your enclosure, please observe the following points:

- What is the installation type to IEC 890 (see page 13, calculation bases)?
- What ambient conditions are anticipated (max. ambient temperature and humidity)?
- What is the required maximum internal temperature of the enclosure (T)?
- What is the heat loss from electronic components inside the enclosure?
- Are there any particular requirements regarding the protection category to EN 60 529/IEC 529?
- What type of ambient pollution, such as dust, oil and chemicals, are the cooling units exposed to?
- For bayed enclosure suites, the output irradiated from neighbouring units may also need to be taken into account.
- Good ventilation should be ensured at the site of installation (for example, the heat dissipated by the cooling unit may cause a significant rise in the temperature of small rooms).
- Particularly with poor ambient conditions, such as dirt or small, unvented rooms, air/water heat exchangers should be used.

Appropriate use of enclosure cooling units

In order to ensure the proper use of enclosure cooling units, the following points should be observed:

1. The unit must only be installed and opened by authorised, expertly trained personnel.
2. Choose a location for the cooling unit which ensures excellent ventilation. The site must be free from excessive dirt and moisture. For example, the atmosphere must not contain any conductive dusts or corrosive media.
3. The mains connection data (connection voltage and frequency) specified on the rating plate must be observed. In the case of 400 V, 2~ cooling units, we recommend the use of transformer circuit-breakers, and for three-phase units, the use of motor circuit-breakers is advisable.
4. The prescribed electrical protection devices must be connected upstream of the unit. No additional temperature control may be connected upstream of the unit at the supply end. The pre-fuse specified on the rating plate should be provided as line protection. Observe the locally valid regulations when installing.
5. Where a door contact switch is used, a shielded cable should be used in environments with increased levels of electromagnetic interference.
6. The temperature range specified on the rating plate must be observed when operating the cooling unit, both indoors and outdoors.
7. The enclosure must be sealed on all sides (IP 54).
8. The air inlet and outlet openings in the internal circuit of the cooling unit must not be obstructed.
9. The cold air flow should not be directed straight at electronic components, to prevent the formation of condensation.
10. The unit must only be installed horizontally, in accordance with the prescribed installation position. The maximum permissible deviation from the horizontal is 2°.
11. After disconnecting from the supply voltage, the cooling circuit of the cooling unit must not be switched back on for at least 5 minutes.
12. The customer must not make any modifications to the cooling unit.
13. The heat loss of the components installed in the enclosure must not exceed the specific useful cooling output of the cooling unit.
14. The installation instructions contained in the cooling unit manual must be observed in full.

Cooling units

External circuit – Flow and siting conditions

In the outer circuit, enclosure cooling units should be spaced > 200 mm from the wall and/or from each other (air inlet and outlet openings). In order to ensure adequate air circulation, at least one air outlet opening must be kept free. If this clearance cannot be maintained, air baffle plates will need to be used.

The external circuit supports all siting options.

Thanks to their compact dimensions and external air routing design, roof-mounted cooling units may even be installed in low-height rooms and with bayed enclosure suites. Air intake is always from the front. The air is expelled at the sides and rear. An outlet to the top is also possible as an option. In other words, regardless of which siting mode is chosen, one air outlet must always be kept free.

Siting options

There are no restrictions here. Only the air intake and exhaust area in front of the cooling unit must be kept free. Wall-mounted cooling units may be mounted on the rear panel, side panels or door of the enclosure.

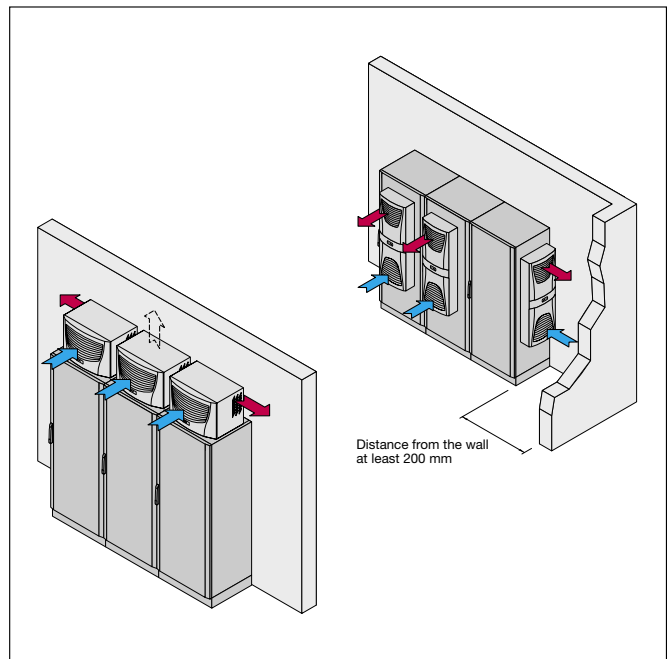

Internal circuit – Wall-mounted units flow conditions

Attention should be paid to installed equipment that is fitted with its own ventilation system, such as blowers and axial fans. If their air flow is directed against the chilled air flow of the cooling unit, the air may short-circuit, bypassing the component. In the worst case, the internal safety systems of the cooling unit would discontinue cooling operation.

Note:

Never direct the chilled air flow at active components.

Accessories:

Air diverter

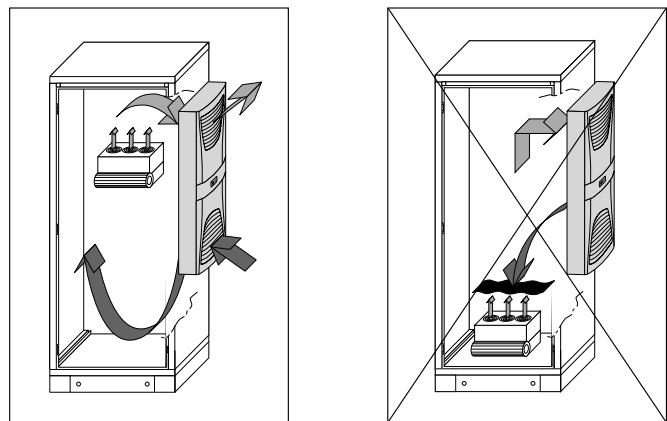

Free air circulation

It is important to ensure “even” air circulation inside the enclosure. Air inlet and outlet openings in the internal circuit must on no account be obstructed by electrical installations. This would prevent air from circulating inside the enclosure. Under such conditions, the cooling capacity of the device would not be adequately utilised. A clearance of > 200 mm must be guaranteed.

Note:

Wall-mounted cooling units should never be fitted directly behind the mounting plate. Active power components are located on the front of the mounting plates. The cooling unit would then be left to operate in its own air short-circuit.

If it is impossible to install the device any other way, appropriate air baffle plates should be used, and air inlet and outlet openings should be provided in the mounting plate.

Accessories:

Air diverter

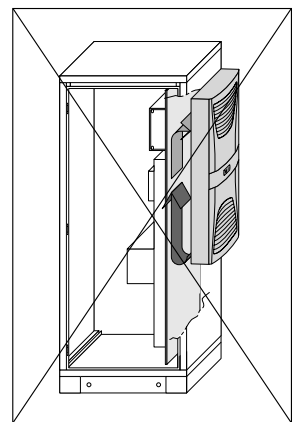
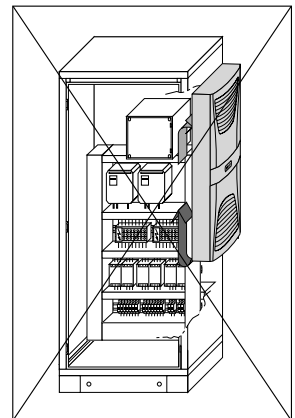
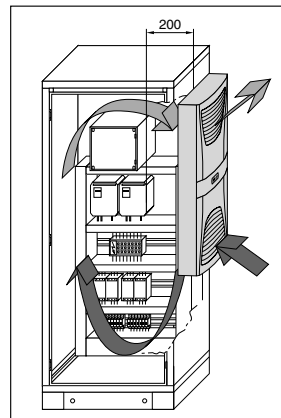

Internal circuit – Roof-mounted units flow conditions

When using roof-mounted units, particular attention should be paid to the air flow from blowers built into electronic components (such as frequency converters and other drive units).

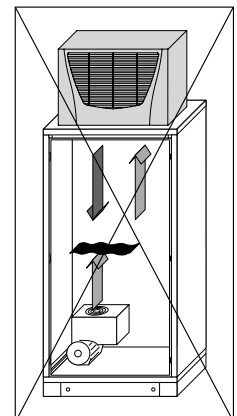
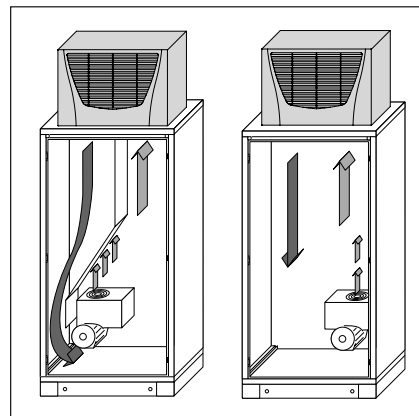

Thermoelectric Cooler



The powerful thermoelectric climate control unit in a lightweight design is the most energy-efficient solution for command panels and small enclosures, producing energy savings of more than 60% compared with conventional systems. Ideal for precision applications thanks to its low-vibration design. Heating function included: Automatic changeover between heating and cooling function facilitates precise temperature control to ± 1 K.

Benefits at a glance:

- 80 watts cooling and heating output with state-of-the-art Peltier technology
- Low-maintenance thanks to an elementary unit layout
- High operating ratio (EER >1) thanks to optimum interplay between all components
- Maximum possible protection for your electronics, floating change-over fault signal contact in case of overtemperature
- Minimal physical size and mass compared with other systems in this sector
- Large voltage range from 100 – 240 V (AC) and 24 V (DC)
- Up to 5 units may be connected in parallel

Thermoelectric Cooler

Simple assembly

Internal mounting

- When internally mounted in the enclosure, the unit only protrudes by a few millimetres, and therefore does not interrupt either the aesthetic appearance or freedom of movement on command panels and support arm systems

External mounting

- Its low weight also allows it to be externally mounted on simple aluminium rear panels or blanking panels

Flexibility

- May be mounted either horizontally or vertically

Ideal for command panels and support arm systems

- The Thermoelectric Cooler is distinguished by its low-vibration operation and minimal weight

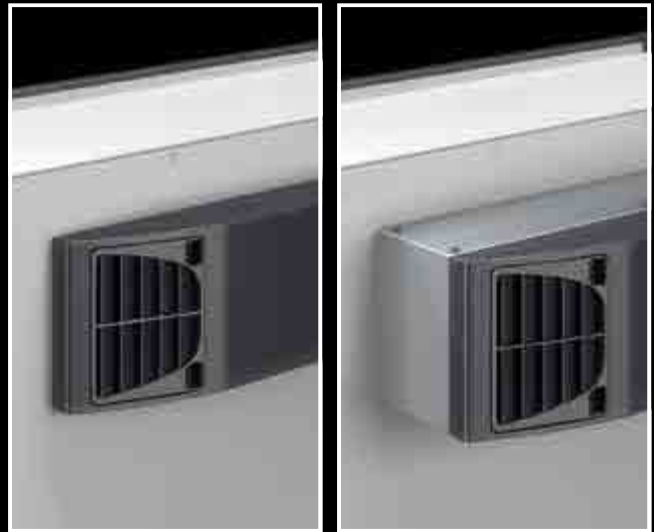

Effective control

- Energy-efficient control with pulse width modulation and innovative soft start function ensures a constant enclosure temperature and a long service life of the Peltier elements and fans.
- The PID control ensures optimum activation of the Peltier elements and fans. The speed and output are adjusted to the ideal operating points via pulse width modulation, and in this way ensure maximum energy efficiency.



Operated via PC software

- The software is available to download from the Rittal homepage. Connect using the enclosed standard USB cable (type A/type B)
- Parameterisation (e.g. setpoints and alarms)
- Monitoring (including current temperatures, fan speeds, capacity utilisation, status display with error messages, operating hours).
- Master/slave settings
 - Parallel connection and networking of multiple devices for additional cooling output using a master/slave adaptor
 - Safety circuit (redundant design)
 - Evaluation (logging of temperature variations, error counters, min./max. temperatures)



Blue e+ wall-mounted cooling units



Sustainable technology for every application

A cooling unit that's at home in any environment. Blue e+ units are ideal for all industries and environments.

Choose from a range of efficient solutions covering all requirements and applications:

- A wide output range covering all cooling requirements from 0.3 kW – 5.8 kW
- Sheet steel version for all typical industry applications
- Stainless steel and chemical versions for challenging ambient conditions
- Maritime version for dynamic applications e.g. on board ships
- Robust outdoor version with anti-vandalism features
- International approvals and multi-voltage capability for worldwide use

Blue e+ wall-mounted cooling units

Blue e+ S wall-mounted cooling units 0.3 kW – 1 kW

- Blue e+ S cooling units with tried-and-tested Blue e+ technology are the world's most energy-efficient cooling units. This means they reduce the carbon footprint of your machines and systems. Available in a brand new design with a host of smart functions.



Blue e+ wall-mounted cooling units 1.6 kW – 5.8 kW

- Available in sheet steel and stainless steel versions



Blue e+ wall-mounted outdoor cooling unit 1.5 kW – 5.0 kW

- The high protection rating of IP 56 / UL type 12/3R/4 and a temperature range of -30 °C to 60 °C provides optimum protection in challenging environments. The cooling unit can be mounted in three different ways (external mounting, partial internal mounting and full internal mounting).



Blue e+ wall-mounted cooling units, chemical 1.6 kW – 5.8 kW

- A special component coating provides optimum protection in contaminated environments – ideal for applications where sulphuric acid may be present in aerosol form.

Blue e+ wall-mounted cooling units, maritime applications 1.0 kW – 2.5 kW

- With a more stable compressor attachment, these cooling units achieve vibration levels to DNV-CG-0339 (Class A), making them suitable for dynamic applications, e.g. on board ships.



Blue e+ wall-mounted cooling units



Blue e+ boasts one-of-a-kind technology, an extended service life for installed components thanks to reduced temperature fluctuations, as well as global usability and integration into the IoT. Its revolutionary energy efficiency is achieved with ingenious hybrid technology, featuring two parallel cooling circuits that can operate independently or in tandem, depending on the temperature difference. The technology draws on the symbiotic power of a passive and an active cooling circuit. Two circuits operating in perfect harmony and adapting to the ambient conditions for maximum efficiency.

The Rittal Blue e+ product family is by far the most efficient generation of cooling units worldwide, streaks ahead of its competitors, with average energy savings of 75%. These are measurable results verified by countless customer tests and references.



At a glance:

Blue e+ for maximum efficiency

- Revolutionary energy efficiency with innovative hybrid technology
 - Two parallel cooling circuits operating independently or in tandem, depending on the temperature difference
 - Passive climate control: Heat pipe cooling circuit (dissipates heat from the enclosure as soon as the ambient temperature drops below the setpoint).
 - Active climate control: Compressor cooling circuit with speed-controlled components for targeted cooling
- Inverter control ensures a constant temperature inside the enclosure to prolong the service life of the components
- This technology has been proven to achieve average energy savings of 75%

One for all

- Unique multi-voltage capability for maximum flexibility
- Global usability with country-specific licences
- Flexible use across a broad temperature range from -20 °C to +60 °C (-30 °C to +60 °C for outdoor cooling units)

Reliability means sustainability

- The high protection rating of IP 55 / IP 56 for outdoor cooling units provides added peace of mind
- More reliable, with integral condensate evaporation as standard from 0.3 kW
- Faster, thanks to short delivery times and dependable worldwide availability of products and spares
- More efficient servicing at a reduced cost, thanks to predictive maintenance

Blue e+ is designed to make your work as easy as possible

- Handy tools for faster design and parametrisation (RiTherm software, Scan & Service app and Quick Finder)
- Planning is a breeze, thanks to uniform square mounting cut-outs for all installation types (external mounting and full internal mounting, partial internal mounting from 1.6 kW)
- Easy access for servicing and maintenance plus simple replacement of components helps keep maintenance work to a minimum

Harry Brot

Impressive energy savings of 60% were achieved in just five months, equivalent to an annual saving of 884 kWh, or € 230 per annum for each cooling unit.



<https://betop.friedhelm-loh-group.com/experience/cool-when-the-heat-is-on.html>



Hansgrohe SE

“Rittal promised energy savings of 60%, and in fact we are currently achieving an impressive 61% in real-life operation. To be honest, we were pleasantly surprised by the results.”

Johannes Kopf, Head of Industrial Engineering Projects at Hansgrohe



<https://betop.friedhelm-loh-group.com/experience/no-mere-drop-in-the-ocean.html>



Blue e+ cooling units for IT applications



Let innovative hybrid technology take the energy efficiency of your rack cooling to a whole new level. An active cooling circuit with speed-controlled components provides demand-based cooling. As soon as the ambient temperature drops below the set level, the integral heat pipe takes over climate control of the rack with passive cooling. This will unlock huge energy savings. The Blue e+ series of cooling units has the perfect solution for all scenarios, be it production facilities, network distribution in small plant rooms or cooling small server applications.

Blue e+ cooling units for IT applications

Blue e+ IT roof-mounted cooling unit

The use of Blue e+ technology makes this bundle ideally suited to the requirements of energy-efficient cooling of IT racks. In combination with the IoT interfaces, it supports communication with various systems as well as monitoring and energy management.

Bundle comprised of the following individual components:

- Roof-mounted cooling unit 3185.730
- IoT interface 3124.300
- Temperature sensor 3124.400
- Connection cable 7030.091
- Nylon loop cable holder 7111.350



Blue e+ IT wall mounted cooling unit

The use of Blue e+ technology makes this bundle ideally suited to the requirements of energy-efficient cooling of IT racks. In combination with the IoT interfaces, it supports communication with various systems as well as monitoring and energy management.

Bundle comprised of the following individual components:

- Wall-mounted cooling unit 3187.930
- IoT interface 3124.300
- Temperature sensor 3124.400
- Connection cable 7030.091
- Nylon loop cable holder 7111.350



Air duct for Blue e+ IT wall-mounted cooling unit

- For supplying cold air in front of the 482.6 mm (19") level
- One air duct for different enclosure depths
- Mounting in the bottom 3 U of the 482.6 mm (19") level



Blue e wall-mounted cooling units



Generation Blue e
Permanent energy savings
with Rittal cooling units.



Top design and top performance with a host of assembly benefits. The Rittal platform strategy with system-wide mounting cut-outs to fit cooling units and air/air heat exchangers allows easy adaptation to the required cooling output, even retrospectively.

Benefits at a glance:

- Energy savings of up to 45%
- Smart control with Comfort controller, icing protection and motor monitoring
- Eco-mode control: The evaporator coil fan cuts out as necessary, depending on the enclosure internal temperature
- Longer service life of components in the enclosure and cooling units, because efficient components such as fans and compressors run at their optimum operating point
- The integral electric condensate evaporation system means that condensate evaporates and dissipates to the ambient air via the external fan
- The hydrophobic RiNano coating prevents the accumulation of dirt deposits on the condenser, thereby extending maintenance intervals and ensuring a constant long-term cooling output

Blue e wall-mounted cooling units

1 TopTherm Blue e

- Overall cooling output 0.3 – 4 kW
- May be linked to the IoT interface via the Blue e IoT adaptor

2 TopTherm Blue e, NEMA 4X

- Overall cooling output 0.5 – 2.5 kW
- Protection category NEMA 4X
- May be linked to the IoT interface via the Blue e IoT adaptor

3 TopTherm Blue e, UL Type 3R/4

- Overall cooling output 0.5 – 2.5 kW
- Protection rating UL Type 3R/4, 12
- Suitable for outdoor siting
- May be linked to the IoT interface via the Blue e IoT adaptor



Flexible wall mounting

Practical and stylish

- Determination of the mounting cut-out depends on the mounting option – either external, internal or partial internal mounting. This makes optimum use of the space available.
- With external mounting, openings are only required for air inlet and outlet
- The enclosure surface containing the cut-out for partial or full internal mounting is stabilised by the divided internal case construction
- Additional internal or external mounting kits are not required



Compatible platform strategy

Flexible output

- Just 5 mounting cut-outs for 8 different output categories provide investment security and facilitate easy adaptation of the cooling output to the ambient conditions and the installed heat loss

Rittal platform strategy

- TopTherm air/air heat exchangers are also compatible with the mounting cut-outs



Integral components

Electrical condensate evaporator

- Condensate arising inside the enclosure or on the evaporator coil of the cooling unit is effectively evaporated. The evaporator device inside the cooling units has a very high evaporation output (several litres per day). This is achieved thanks to the principle of direct evaporation.

Hydrophobic RiNano coating

- The condenser with standard hydrophobic RiNano coating ensures a longer, constant cooling output and eliminates the need for filter media in many areas



Blue e roof-mounted cooling units



Generation Blue e
Permanent energy savings
with Rittal cooling units.



Cooling units keep the enclosure internal temperature at a constant level.

The air routing meets individual requirements. Two separate circuits prevent the ingress of dust into the enclosure. Rittal Blue e roof-mounted cooling units: Top design and top performance with a host of assembly benefits and sophisticated air routing. Superb performance plus cost-cutting design.

Benefits at a glance:

- Super-efficient in terms of performance and energy consumption
- Wide output range from 500 to 4000 W
- Three-phase cooling units support multiple voltages as standard
- Uniform, performance-related, system-wide mounting cut-outs
- Targeted, individual air routing
- Electrical condensate evaporation and hydrophobic RiNano coating

Important:

- Avoid overloading the roof plate by using stays (with VX25 system accessories)

Blue e roof-mounted cooling units

Flexibility of roof mounting

Cut your costs

- All three-phase cooling units are suitable for a voltage range of 400 V, 50 Hz and 460 V, 60 Hz without rewiring. No need for expensive additional transformers.

Flexible output

- Just 3 mounting cut-outs for 6 different output categories provide investment security and facilitate easy adaptation of the cooling output to the ambient conditions and the installed heat loss

Rittal platform strategy

- TopTherm air/water heat exchangers are also compatible with the mounting cut-outs



Optimum flow conditions

Targeted air routing inside the enclosure

- The internal air circulation is targeted and effective: The heated air is extracted centrally. Chilled air is discharged via up to four spigots positioned in the corners of the base plate and may be routed in a controlled manner into the lower enclosure chamber via the optional ducting system. The result is highly effective cooling and the avoidance of air short-circuits. The targeted air circulation inside the enclosure via ducts also prevents the creation of hot-spots.



Integral components

Electrical condensate evaporator

- Condensate arising inside the enclosure or on the evaporator coil of the cooling unit is effectively evaporated. The evaporator device inside the cooling units has a very high evaporation output (several litres per day). This is achieved thanks to the principle of direct evaporation.

Hydrophobic RiNano coating

- The condenser with standard hydrophobic RiNano coating ensures a longer, constant cooling output and eliminates the need for filter media in many areas.



Blue e roof-mounted cooling units

Condensate routing

All roof-mounted cooling units have electrical condensate evaporation.

Additional condensate routing is provided merely as an extra safeguard only. Any condensation which forms on the evaporator coil (with high humidity and low enclosure interior temperatures) is routed to the right and/or downwards out of the device via a drain in the evaporator tray. For this purpose, a piece of hose should be connected to one of the two condensate nozzles (1 or 2). **The drain which is not required should be tightly sealed. The condensate must be able to run off freely. If the condensate is to be drained off over a greater distance, then care must be taken to ensure that the hose is free from kinks** and checked for correct drainage. Units with an e-Comfort controller are additionally equipped with a condensate alarm.

1 Condensate discharge rear

2 Condensate discharge right

Note:

Condensate discharge (wall-mounted units)

For wall-mounted units, a hose should be connected to the condensate nozzle on the bottom of the unit.

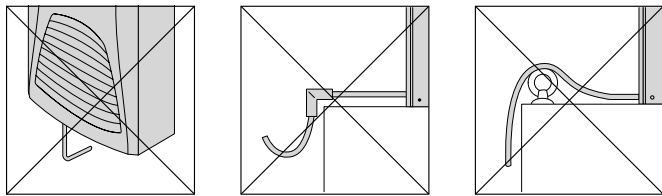

The condensate drain pipe should be laid with a gradient, taking care to ensure there are no kinks in the pipe!

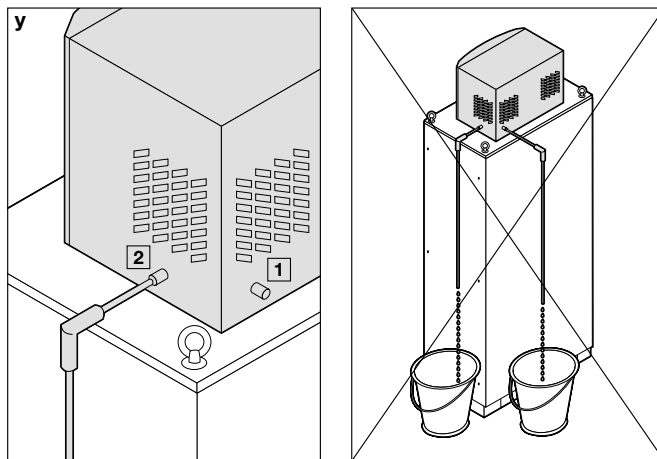
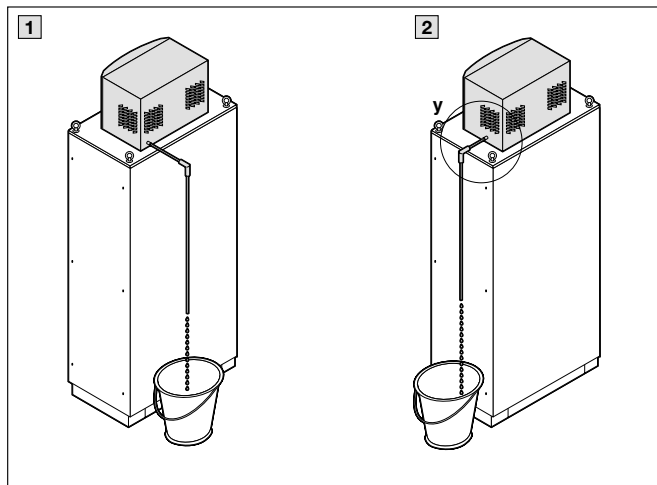

Blue e+ roof-mounted cooling unit

Available with 1.3 kW total cooling output



Modular climate control concept



Generation Blue e
Permanent energy savings
with Rittal cooling units.



Less is more! We offer almost limitless application possibilities from just four cooling modules and six door modules. The best cooling technology, complete and ready for use – without having to make mounting cut-outs. The existing sheet steel doors are easily exchanged for climate control doors with cooling modules. These can also be exchanged or upgraded while the system is operational.

Benefits at a glance:

- Modular design – for specific size, cooling power and voltage combinations
- Combination of VX25 climate control door and cooling module
- One item number each for the door and climate cooling module
- May be linked to the IoT interface via the Blue e IoT adaptor

Important:

- A base/plinth is required for operation

Modular climate control concept

Extensive modularity

- Create your individual climate control solution from the climate control door and the cooling module in just a few simple steps
- Choose from different options with different dimensions, cooling outputs and voltages



Infinite possibilities

- Seamless baying and perfect integration. Cooling of a bayed enclosure suite is easily achieved, even under awkward room conditions, such as low ceiling heights.
- No mounting cut-outs are required



Wide range of options

- 1 Cooling module, 1500 W total cooling output, available with two voltage options
- 2 Cooling module, 2500 W total cooling output, available with two voltage options
- 3 Climate control door for installing cooling modules in 600 or 1200 mm wide VX25 enclosures, cooling module on the right, in 1800 and 2000 mm height
- 4 Climate control door for installing cooling modules in 800 mm wide, 1-door VX25 enclosures, in both 1800 and 2000 mm height
- 5 Climate control door for installing cooling modules in 1200 mm wide VX25 enclosures, cooling module on the left, in both 1800 and 2000 mm height

Benefit:

For 1200 mm wide VX25 enclosures, the existing hinged door may be used, irrespective of the device position (left or right)

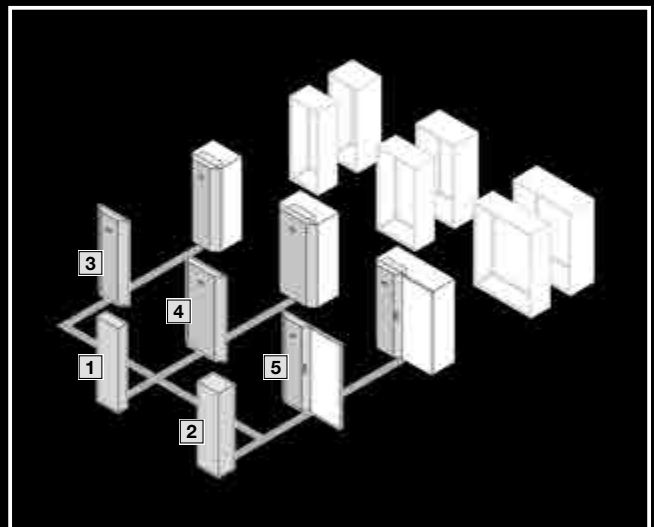

Enclosure heaters



Enclosure heaters are used to prevent the formation of condensation inside the enclosure and maintain a constant minimum operating temperature (e.g. when the system is switched off overnight).

Rittal TopTherm heaters, with self-regulating PTC technology, ensure constant heat distribution with outputs in the range of 10 W – 150 W, for those not fitted with a fan and 250 W – 800 W for fan-assisted options. For heaters with fans, a minimum safety clearance of 300 mm at the top must be observed, and the equivalent figure for heaters without fans is 100 mm. In each case the thermal safety clearance to the sides of 60 mm, and 100 mm at the bottom is required.

Fast assembly system:

- Quick-connect terminal for power supply
- Terminal suitable for parallel connection of an additional heater
- Minimal wiring work

Superior efficiency:

- Energy-saving self-regulating PTC technology
- Superior thermal output with an identical construction size
- Constant distribution of heat

Greater flexibility:

- Output range: 10 – 800 W
- Attachment on a 35 mm top hat rail or mounting plate

Enclosure heaters

Fast assembly

- Snap-fastening onto 35 mm support rails EN 50 022
- Direct screw-fastening onto the mounting plate
- Quick-connect terminal for power supply (spring terminal)
- No need for any other terminals
- No wiring required



Energy-efficient design

- PTC technology for constant heat distribution
- Computational Fluid Dynamics (CFD)-assisted design for superior heating performance with the same construction size



Constant continuous thermal output

- Without fan 10, 20, 30, 50, 75, 100 and 150 W
- Rated operating voltage: 110 – 240 V, AC/DC 50/60 Hz
- With fan 250, 400 and 800 W
- Rated operating voltage: 115 V, 50/60 Hz and 230 V, 50/60 Hz



Self-regulating PTC technology

Energy-efficient PTC technology and design optimisation on the basis of computational fluid dynamics (CFD) permit improved heating outputs from units of the same size compared to the previous product versions.

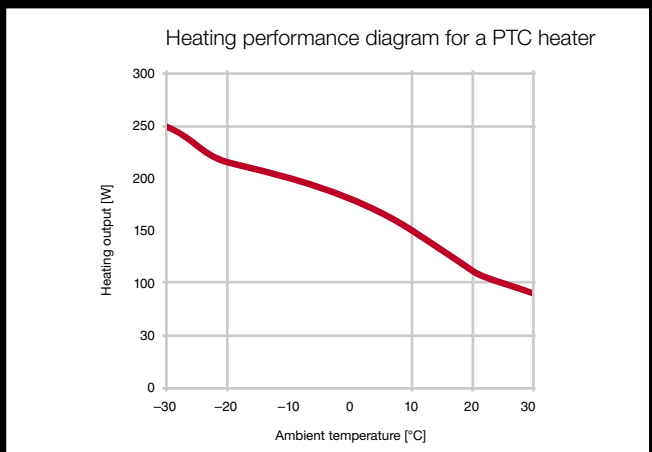

Enclosure heaters

Project management

The required thermal output is calculated from:

$$\dot{Q}_H = A \cdot \Delta T \cdot k$$

Heating performance diagram

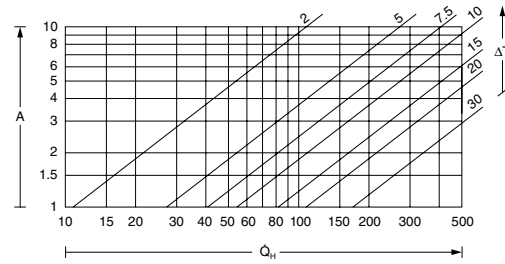

\dot{Q}_H = Thermal output (W)
 A = Enclosure surface area to IEC 890 (m²)
 ΔT = Temperature difference (K)
 k = Heat transfer coefficient

Based on:

Indoor siting, static air,
 heat transfer coefficient $k = 5.5 \text{ W/m}^2 \text{ K}$

For outdoor siting (moving air):

Double the determined thermal output

Even temperature distribution

Via a CFD analysis, even temperature distribution in the (empty) enclosure is observed when using a 400 W enclosure heater following a heating period of approx. 30 minutes. According to the CFD analysis, positioning of the enclosure heater in the base area of the enclosure is essential for even temperature control of the enclosure, since those areas located beneath the heater are only minimally warmed.

Temperature °C

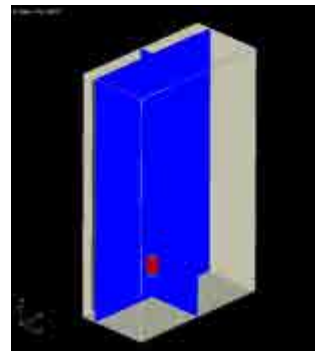
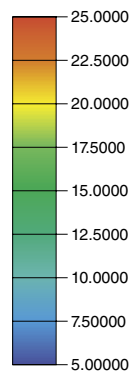

Start

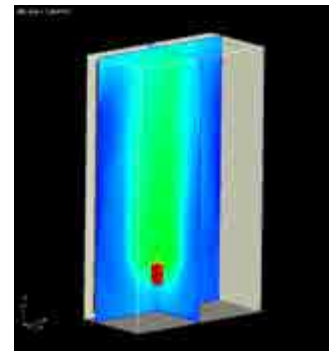

After 5 minutes

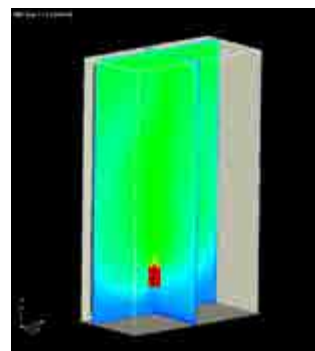

After 15 minutes

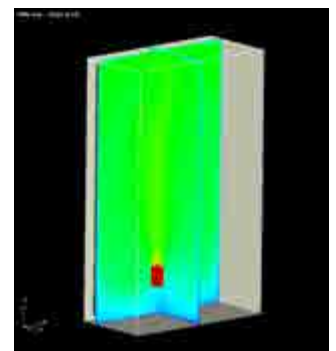

After 30 minutes

Cutting carbon emissions the Blue e+ way



More about
carbon footprints:

www.rittal.com/CO2Footprint

Control, protection and monitoring accessories



Boost your cooling efficiency with optimum control

Finding the perfect climate control solution is now easier than ever with matching system accessories that tailor climate control components perfectly to your requirements. From parametrisation to targeted air routing and precise control of the equipment, Rittal has the right solution for every application.

Benefits at a glance:

- Complete system solutions
- Perfectly coordinated components

Accessories for fan-and-filter units

Efficient control

- Temperature-dependent speed control for fan-and-filter units
- Quieter operation, energy savings and a longer service life for the fan-and-filter unit
- Controlling the air flow reduces contamination of the filter, extends maintenance intervals and thus saves costs



Optimum air routing

- The greater surface area and lower pressure drop of the filter result in a higher volumetric air flow via the fan, and in turn enable both improved performance and reduced energy consumption
- The enhanced filtration properties mean that less dust penetrates. At the same time, the extended filter replacement intervals contribute to significantly reduced maintenance costs.

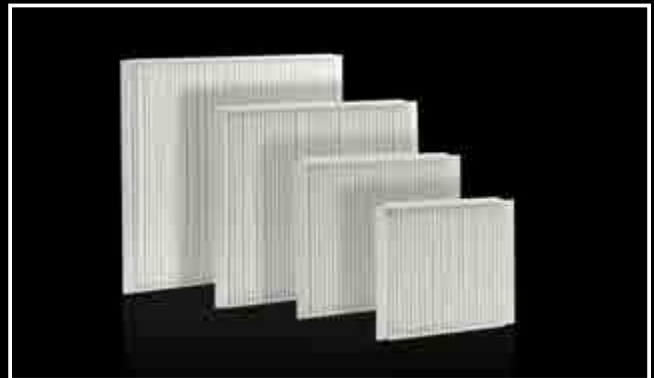

Effective control

- Thermostat controls fans and heaters in accordance with the enclosure inside temperature
- Hygrostat activates heaters or fans when a defined relative humidity is exceeded in the enclosure



Accessories for cooling units



Standard-compliant protection

- Circuit-breakers for standard-compliant protection of the connection cables for Blue e+ cooling units and chillers (IEC and UL applications)



Optimum air routing

- Targeted routing of the cold air flow to avoid hotspots in the enclosure
- Particularly well-suited for densely-packed electrical components in the enclosure

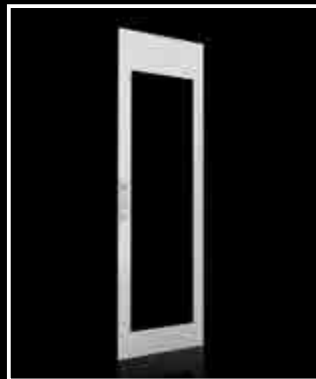
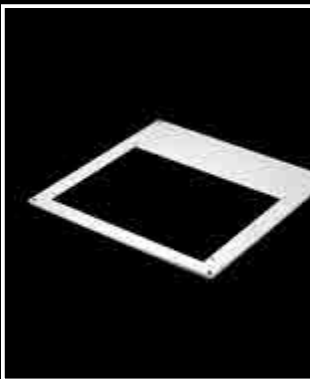

Simple assembly

- Roof plates and sheet steel doors in various dimensions with appropriate cut-outs for Blue e+ wall- and roof-mounted cooling units

Accessories for cooling units

IoT interface

Digitalised and networked, for fast, uninterrupted, automated production

Industry 4.0 scenarios are based on data supply and networked communications. This relies on IoT-compatible devices that are equipped with the relevant communication capabilities.

Rittal's new IoT interface creates the basis for optimum integration of cooling units, chillers, fan-and-filter units and sensors into Industry 4.0 applications. This facilitates end-to-end communications from the sensor to the cloud as well as connection to higher-level monitoring or energy management systems.

A failure in the enclosure and process cooling system can quickly lead to unplanned plant shutdowns and expensive downtime and consequential costs. In conjunction with the IoT interface, all Rittal chillers in the Blue e+ series, all cooling units in the Blue e and Blue e+ series and all Blue e+ fan-and-filter units with EC technology can now be retroactively networked and digitalised without affecting the automation logic.

Plug and run: The IoT interface is quickly and conveniently configured and commissioned via the integral web server without the need for programming. This digital retrofit supports the latest condition monitoring technology and will significantly boost your system availability.

Your benefits:

- Continuous monitoring of temperature levels and temperature accuracy
- Prompt action if a threshold value is exceeded
- Automatic notification of cooling unit, fan-and-filter unit and chiller malfunctions
- Temperature records and energy efficiency analyses
- Avoidance of downtime costs and consequential damage
- Remote access: Device parameters can be configured remotely



www.rittal.com/iot

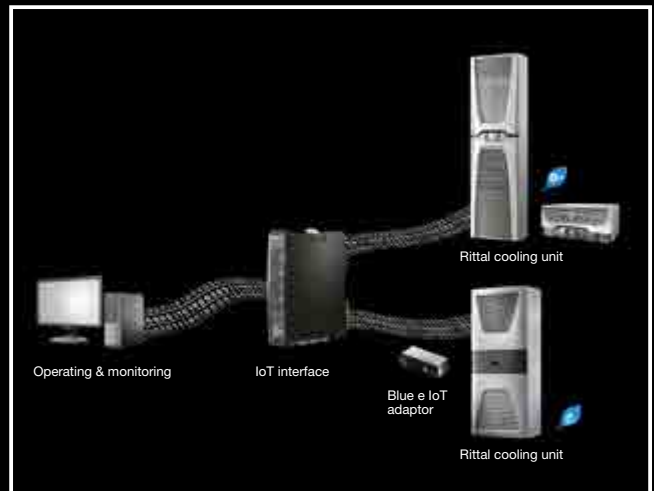

Software and services



Eplan Data Portal

The Eplan Data Portal is an integral web service in the Eplan platform, providing online access to device data from well-known manufacturers. This data is easily inserted into wiring plans using stored macros, and Eplan automatically generates parts lists with item numbers. This reduces project planning work and delivers superior system documentation.

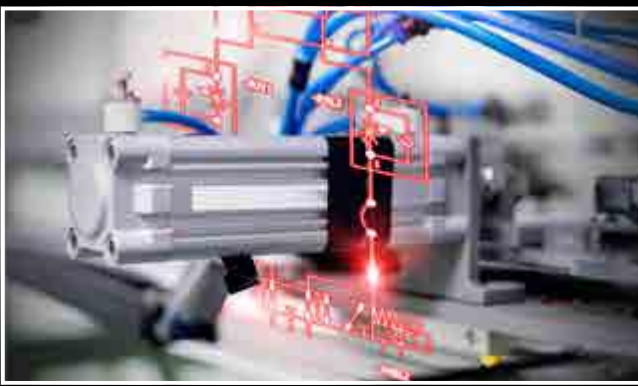

Eplan Fluid

Eplan Fluid is your engineering tool for project-planning fluid engineering systems (hydraulics, pneumatics, cooling and lubrication) using a range of engineering techniques. Machine and plant documentation is completed automatically using logged project data, for more than just wiring plans.



RiPanel

RiPanel makes it easier to select the right enclosure system and accessories, offers automatic 3D positioning and plausibility checks, supports customised cut-outs with CAD imports, and generates technical data for direct enquiries and orders. This saves time, prevents errors and speeds up your planning and ordering processes.



Rittal ePOCKET

With the Rittal ePOCKET digital wiring plan pocket, your equipment and system documentation is always up-to-date. What's more, it can be accessed directly from any device, any time and anywhere.

Project data is quickly and easily available in a secure digital wiring plan pocket. This helps to avoid queries about lost or damaged documents while also streamlining communications with the customer. Digital project data is always available directly on the system; incorrect or out-of-date versions are a thing of the past. Projects are stored in the cloud and accompany the enclosure throughout the entire value chain.

Software and services

RiTherm

That moment when you start planning your enclosure climate control and realise that cost-effectiveness and climate protection are in perfect balance. Then realise that you will experience it over and over again, with a host of new functions. RiTherm is your free planning software for targeted, reliable, energy-efficient climate control of switchgear with standard-compliant documentation and carbon footprint certificate.

Features of the new RiTherm:

Quickly and easily design the correct climate control for your switchgear

- Calculate and select all ambient conditions
- Optionally define your altitude (which influences the cooling output)
- Calculate bayed enclosure suites according to your requirements
- Get recommendations for matching accessories

Integral energy efficiency calculator

- Energy efficiency calculation for individual climate zones
- Suggestions for more energy-efficient alternatives
- Calculate the carbon footprint of your climate control system, from delivery through to operation
- Information about F-gases / Global Warming Potential (GWP)

Full documentation

- Standard-compliant heat dissipation record
- All required product information (such as approvals) is provided
- Display your product lifecycle status with reference to successor products

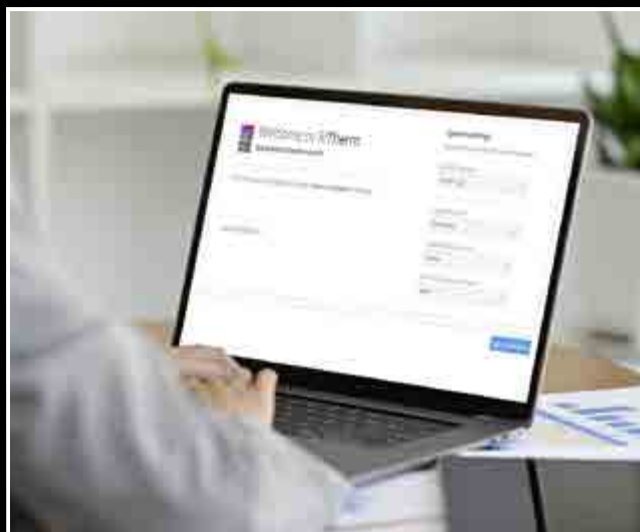

Software and services



Software and services

Global service network

Wherever your cooling unit is located, we are on hand to assist. Our global service network means you can rely on consistent quality. You can always depend on our support. For smaller problems, our hotline offers fast, easy advice, while our on-site service technicians are available to assist with device replacement and maintenance.

- All from a single source
- Manufacturer expertise
- Always nearby



Scan & Service app

Want to configure your climate control devices quickly and easily? With our Scan & Service app, you can. Simply scan the QR code on the rating plate for detailed information about every Rittal product. The NFC scan provides a status overview

- Save time by transferring your settings to other cooling units
- Contact Rittal around the clock
- Easily request accessories and spare parts

Register your product now in the app and get an extended warranty.

Download here:

App store



Efficiency and service check

Is your cooling unit still efficient and up-to-date? Our Rittal efficiency & service check can test it for you! We will take an inventory for you and show you how much you could save using our energy analyses – better for the environment and for your wallet.

- Review of the current performance levels of your units
- Presentation of energy costs and potential savings
- Specific approaches for energy audits to DIN EN 16247-1



Rittal – The System.

Faster – better – everywhere.

- Enclosures
- Power Distribution
- Climate Control
- IT Infrastructure
- Software & Services

You can find the contact details of all Rittal companies throughout the world here.



www.rittal.com/contact

XWWW00107EN2307

ENCLOSURES

POWER DISTRIBUTION

CLIMATE CONTROL

IT INFRASTRUCTURE

SOFTWARE & SERVICES



FRIEDHELM LOH GROUP