

# **Rittal – The System.**

Faster – better – everywhere.

**Kabelabfangschiene,  
tiefenverstellbar**

**Cable clamp rail, depth-adjustable**

**Rail de retenue des câbles  
réglable en profondeur**

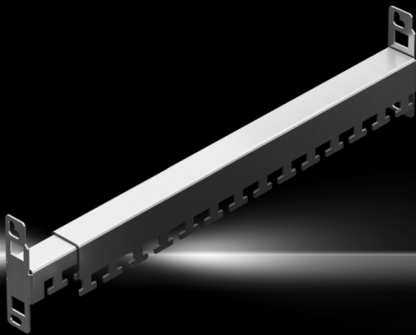

VX IT 5302.044

**Montageanleitung  
Assembly instructions  
Notice de montage**

ENCLOSURES

POWER DISTRIBUTION

CLIMATE CONTROL

IT INFRASTRUCTURE

SOFTWARE & SERVICES

FRIEDHELM LOH GROUP



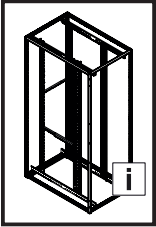

**Inhaltsverzeichnis**  
**Contents**  
**Sommaire**

DE

<b>1. Hinweise zur Dokumentation</b>	<b>4</b>
1.1 Aufbewahrung der Unterlagen	4
1.2 Verwendete Symbole	4
1.3 Bestimmungsgemäße Verwendung	4
<b>2. Zusätzliches Zubehör</b>	<b>5</b>
<b>3. Sicherheitshinweise</b>	<b>5 – 8</b>
<b>4. Montage Kabelabfangschiene, tiefenverstellbar</b>	<b>9 – 10</b>

EN

<b>1. Notes on documentation</b>	<b>4</b>
1.1 Storing the documents	4
1.2 Symbols used	4
1.3 Intended use	4
<b>2. Additional accessories</b>	<b>5</b>
<b>3. Safety instructions</b>	<b>5 – 8</b>
<b>4. Mounting the cable clamp rail, depth-adjustable</b>	<b>9 – 10</b>

FR

<b>1. Remarques relatives à la documentation</b>	<b>4</b>
1.1 Conservation des documents	4
1.2 Symboles utilisés	4
1.3 Utilisation correcte	4
<b>2. Accessoires complémentaires</b>	<b>5</b>
<b>3. Consignes de sécurité</b>	<b>5 – 8</b>
<b>4. Montage du rail de retenue des câbles réglable en profondeur</b>	<b>9 – 10</b>

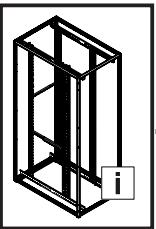

**Inhaltsverzeichnis**  
**Contents**  
**Sommaire**

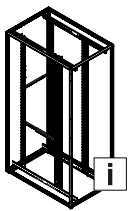

2 – 8

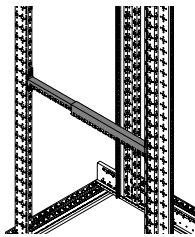

9

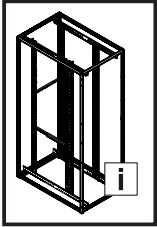

	Bestell.-Nr. Model No. Référence	
t [mm]		350 – 550
	ST5,5x13	6
		4

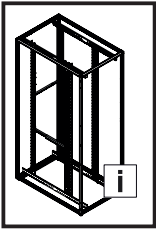

## Abkürzungsverzeichnis Table of abbreviations Répertoire des abréviations

DE

- $M_A$ : Anzugsdrehmoment
- t: Innenmaß

EN

- $M_A$ : Tightening torque
- t: Internal dimension

FR

- $M_A$ : Couple de serrage
- t: Dimension intérieure

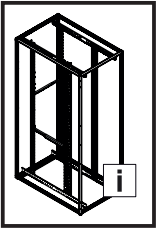

## 1. Hinweise zur Dokumentation 1. Notes on documentation 1. Remarques relatives à la documentation

DE

Die **Montageanleitung** richtet sich an Personen, die Einrichtungen der Informations- und Telekommunikationstechnik unter Kenntnis der länderspezifischen Sicherheitsvorschriften am Bestimmungsort aufstellen, anschließen und betreiben.

### 1.1 Aufbewahrung der Unterlagen

Die Dokumentation ist Teil des Produktes. Sie muss dem Anlagenbetreiber ausgehändigt werden. Dieser übernimmt die Aufbewahrung, damit die Unterlagen im Bedarfsfall zur Verfügung stehen.

### 1.2 Verwendete Symbole

Beachten Sie folgende Sicherheits- und sonstige Hinweise in der Anleitung:

#### Sicherheits- und andere Hinweise:



**Gefahr!**  
Unmittelbare Gefahr für Leib und Leben.



**Achtung!**  
Mögliche Gefahr für Produkt und Umwelt.



**Hinweis:**  
Nützliche Informationen und Besonderheiten.



**Hinweis:**  
Front-/Rückansicht.

EN

These **assembly instructions** have been written for personnel tasked with assembling, connecting and operating IT and telecommunication equipment at the intended location and who are familiar with the country-specific safety regulations.

### 1.1 Storing the documents

The safety notes and the accompanying note are part of the product. They must be given to the plant operator, who is then responsible for the storage of the documents so that they are readily available when needed

### 1.2 Symbols used

Please observe the following safety instructions and other notes in this guide:

#### Safety and other notes:



**Danger!**  
Immediate danger to life and limb.



**Caution!**  
Potential threat to the product and its environment.



**Note:**  
Useful information and special features.



**Note:**  
Front/rear view.

FR

La **notice de montage** s'adresse aux personnes qui installent, raccordent et exploitent les installations IT et de télécommunication, dans le respect des prescriptions de sécurité spécifiques au pays où elles sont installées.

### 1.1 Conservation des documents

Les consignes de sécurité et la notice jointe font partie du produit. Elles doivent être remises à l'exploitant de l'installation. Celui-ci les conservera de manière à ce qu'elles soient disponibles en cas de besoin.

### 1.2 Symboles utilisés

Tenir compte des consignes de sécurité et autres directives contenues dans cette notice :

#### Consignes de sécurité et autres directives :



**Danger !**  
Risque de blessure grave, voire mortelle.



**Attention !**  
Danger éventuel pour le produit et l'environnement.



**Remarque :**  
Informations utiles et particularités.



**Remarque :**  
F = vue frontale  
R = vue arrière

### 1.3 Bestimmungsgemäße Verwendung

Kabelabfangschiene zur senkrechten Kabelführung im Seitenbereich bzw. in einer 19"-Höheneinheit von VX IT Racks.

### 1.3 Intended use



Cable clamp rail for vertical cable routing in the side section or in a 482.6 mm (19") height unit (U) of VX IT racks.

### 1.3 Utilisation correcte

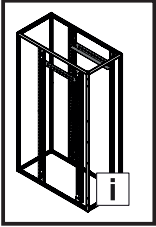
Rail de retenue des câbles pour le guidage vertical des câbles sur le côté ou dans une unité de hauteur 19" des baies VX IT.



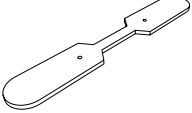

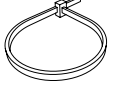

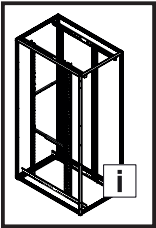
**2. Zusätzliches Zubehör**  
**2. Additional accessories**  
**2. Accessoires complémentaires**

	Best.-Nr. Model No. Référence
	7072.220 7072.230 7072.240
	2203.400
	2597.000



**3. Sicherheitshinweise**      **3. Veiligheidsvoorschriften**      **3. Instrucciones de seguridad**  
**3. Safety instructions**      **3. Säkerhetsinstruktioner**  
**3. Consignes de sécurité**      **3. Istruzioni di sicurezza**

	DE	EN	FR	NL	SE	IT	ES
	Warnung vor der Schließbewegung von mechanischen Teilen einer Maschine/Einrichtung	Warning against closing movements for mechanical parts of a machine/device	Danger dû à la fermeture des pièces mécaniques d'une machine / installation	Waarschuwing voor de sluitbeweging van mechanische onderdelen van een machine/voorziening	Varning för stängningsrörelse på mekaniska delar i en maskin/enhet	Prestare attenzione alla chiusura delle parti meccaniche di una macchina o di un dispositivo	Atención, movimiento de cierre de componentes mecánicos en una máquina/instalación
	Warnung vor sich bewegenden mechanischen Teilen	Warning against independently moving parts	Danger dû à des pièces mécaniques mobiles	Waarschuwing voor bewegende mechanische onderdelen	Varning för rörliga mekaniska delar	Prestare attenzione alle parti meccaniche in movimento	Atención, componentes mecánicos en movimiento
	Warnung vor spitzem Gegenstand	Caution: Sharp object	Attention aux objets pointus	Waarschuwing voor scherpe voorwerpen	Varning för vassa föremål	Pericolo oggetto affilato	Advertencia de objetos puntiagudos
	Warnung vor Hindernissen im Kopfbereich	Caution: Obstructions in head area	Attention aux obstacles au niveau de la tête	Waarschuwing voor obstakels op hoofdhoogte	Varning för hinder i huvudhöjd	Pericolo ostacolo in alto	Advertencia de obstáculos en la zona de la cabeza
	Die Anleitung ist zu lesen	The instructions must be read	La notice doit être lue	Lees de gebruiksaanwijzing	Bruksanvisningen måste läsas	Leggere le istruzioni	Leer el manual de instrucciones

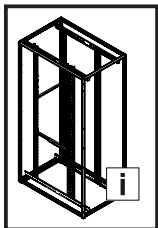

**3. Turvallisuusohjeet**  
**3. Sikkerhedsanvisninger**  
**3. Wskazówki dotyczące bezpieczeństwa**

**3. Bezpečnostní pokyny**  
**3. Инструкции за безопасност**  
**3. Меры безопасности**

	FI	DK	PL	CZ	BG	RU
	Varoitus koneen/ laitteen mekaanisten osien sulkuliikkeestä	Advarsel mod lukkebevægelse af mekaniske dele i en maskine/ indretning	Uwaga na zamykające się części mechaniczne maszyny lub urządzenia	Výstraha před rizikem úrazu ruky	Предупреждение за движение от затварящи се механични части на машина/ оборудване	Предупреждение об опасности при закрывании механических частей машины/ установки
	Varoitus liikkuvista mekaanisista osista	Advarsel mod uafhængigt bevægelige dele	Uwaga na ruchome części mechaniczne	Výstraha; Rozmačkání	Предупреждение за движещи се механични части	Предупреждение об опасности движущихся механических частей
	Varo teräviä reunoja	Advarsel: Spidse genstande	Ostrzeżenie przed ostrym przedmiotem	Varování před ostrým předmětem	Предупреждение за опасност от остър предмет	Предупреждение об остром предмете
	Varo putoavia esineitä	Advarsel: Forhindringer i hovedhøjde	Ostrzeżenie przed przeszkodami w pobliżu głowy	Varování před překážkami v oblasti hlavy	Предупреждение за опасност от препятствия в областта около главата	Предупреждение о препятствиях в верхней области головы
	Lue käyttöohjeet	Vejlædningen skal læses	Przeczytać instrukcję	Odkaz na instrukce návodu k použití/brožury	Прочетете ръководството	Прочитать руководство

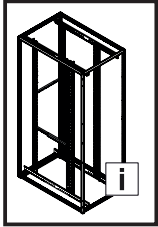

**3. Υποδείξεις ασφαλείας**  
**3. Instrucțiuni de siguranță**  
**3. Sigurnosne upute**



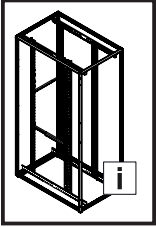

**3. Biztonsági utasítások**  
**3. Saugos nurodymai**  
**3. Ohutusjuhised**

**3. Drošības norādījumi**

	GR	RO	HR	HU	LT	EE	LV
	Προειδοποίηση πριν από την κίνηση κλειδώματος μηχανικών μερών μίας εγκατάστασης/μηχανήματος	Avertizare cu privire la mișcarea de închidere a pieselor mecanice ale unei mașini/ale unui dispozitiv	Upozorenje na opasnost od uklještenja mehaničkih dijelova stroja/uređaja	Gép/berendezés mechanikai részekenek zárómozgására történő figyelmeztetés	Įspėjimas dėl mašinos / įrenginio mechaninių dalių judėjimo, užsidarymo metu	Hoiatus masina/ seadme mehhaaniliste osade sulgemisliikumise eest	Uzmanieties iekārtas/mašīnas mehānisko daļu aizvēršanās laikā
	Προειδοποίηση από κινούμενα μηχανικά μέρη	Avertisment cu privire la piesele mecanice aflate în mișcare	Upozorenje na mehaničke dijelove koji su u pokretu	Mozgó mechanikai részekre történő figyelmeztetés	Įspėjimas dėl judančių mechaninių dalių	Hoiatus liikuvate mehhaaniliste osade eest	Uzmanieties no kustīgām mehāniskām daļām
	Προειδοποίηση αιχμηρού αντικειμένου	Avertizare privind obiecte ascuțite	Upozorenje na šiljati predmet	Figyelmeztetés hegyes tárgyakk veszélyére	Įspėjimas apie aštrų daiktą	Hoiatus terava eseme eest	Brīdinājums par asiem priekšmetiem
	Προειδοποίηση για εμπόδια στην περιοχή της κεφαλής	Avertizare privind obstacole în zona capului	Upozorenje na zapreke u području glave	Figyelmeztetés fejmagasságban található akadályokra	Įspėjimas apie kliūtis galvos aukštyje	Hoiatus pea piirkonnas asuvate takistuste eest	Brīdinājums par šķēršļiem galvas zonā
	Απαιτείται το διάβασμα των οδηγιών	A se citi manualul	Pročitajte upute	Az utasítást el kell olvasni	Skaityti instrukciją	Lugeda kasutusjuhendit	Izlasiet instrukciju



**3. Varnostni napotki**  
**3. Bezpečnostné pokyny**  
**3. Instruções de segurança**

	SI	SK	PT
	Opozorilo pred zapiranjem mehanskih delov stroja/naprave	Dávajte pozor na zatvárací pohyb mechanických častí stroja/zariadenia	Cuidado quando as partes mecánicas de uma máquina/instalação se fecham
	Opozorilo pred premikajočimi se mehanskimi deli	Dávajte pozor na pohyblivé mechanické časti	Cuidado com as partes mecánicas móveis
	Opozorilo pred ostrim predmetom	Varovanie pred predmetom s ostrým hrotom	Cuidado com objetos pontiagudos
	Opozorilo pred ovirami v višini glave	Varovanie pred prekážkami v priestore hlavy	Cuidado com objeto à altura da cabeça
	Preberite navodila	Prečítajte si návod	Ler as instruções



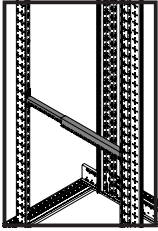

TX30



DE EN FR

- 4. Montage Kabelabfangschiene, tiefenverstellbar
- 4. Mounting the cable clamp rail, depth-adjustable
- 4. Montage du rail de retenue des câbles réglable en profondeur

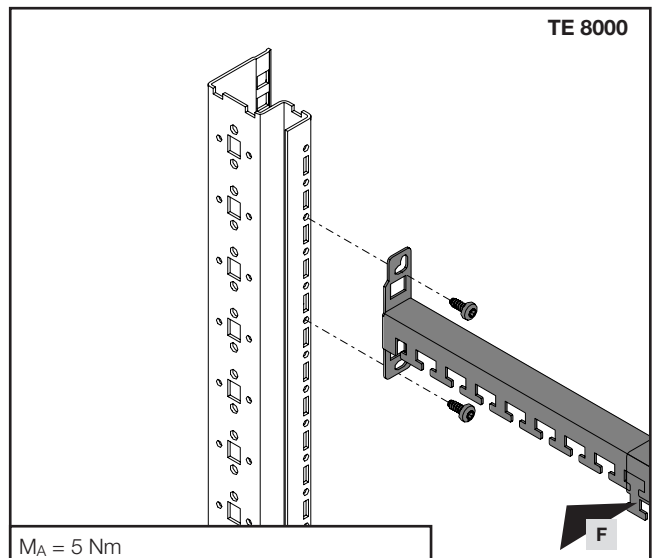
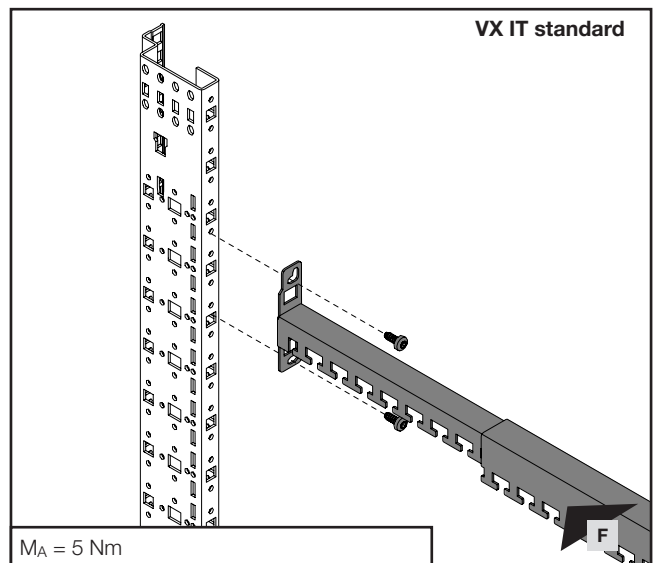
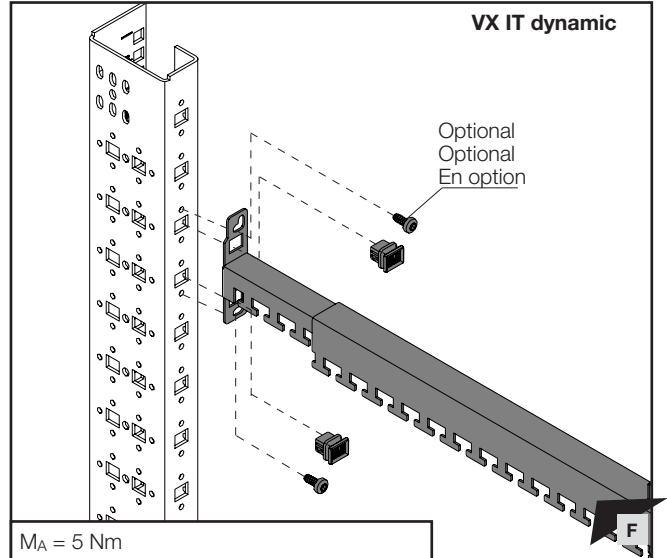
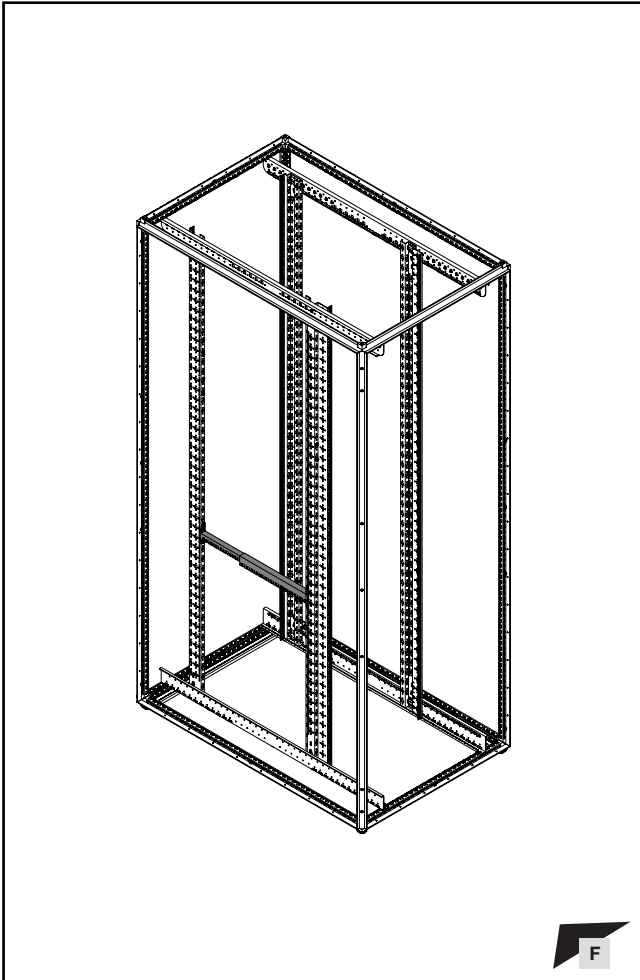

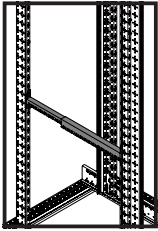

TX30



- 4. Montage Kabelabfangschiene, tiefenverstellbar
- 4. Mounting the cable clamp rail, depth-adjustable
- 4. Montage du rail de retenue des câbles réglable en profondeur

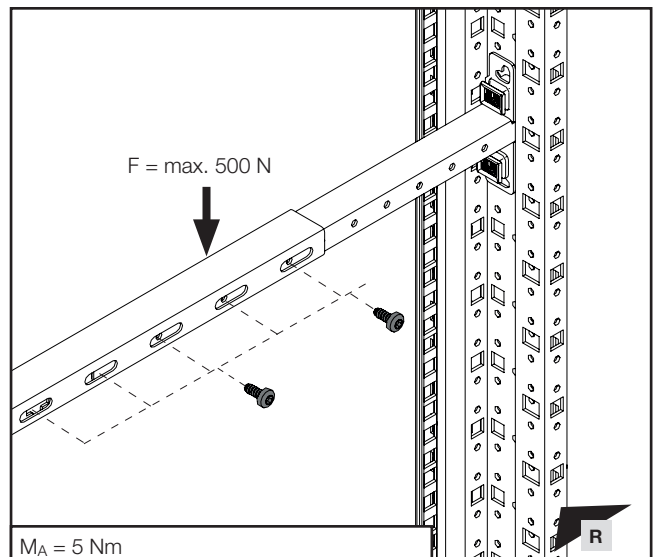
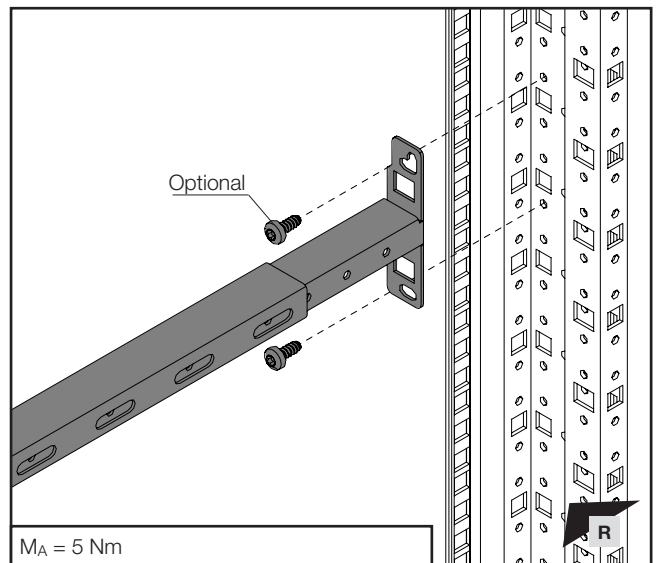
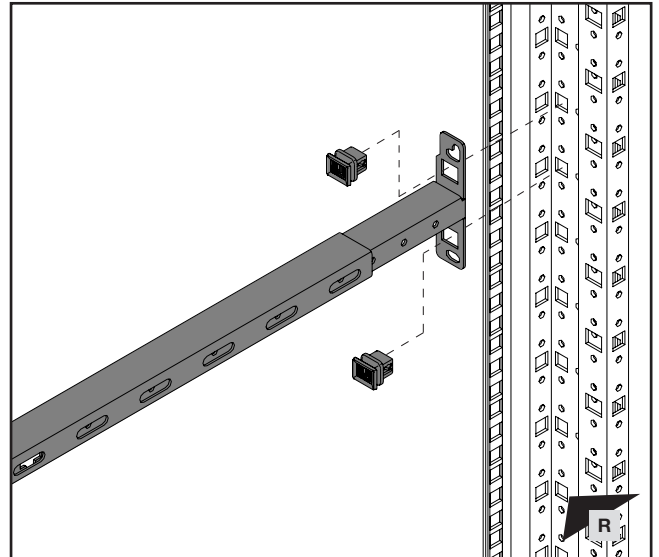
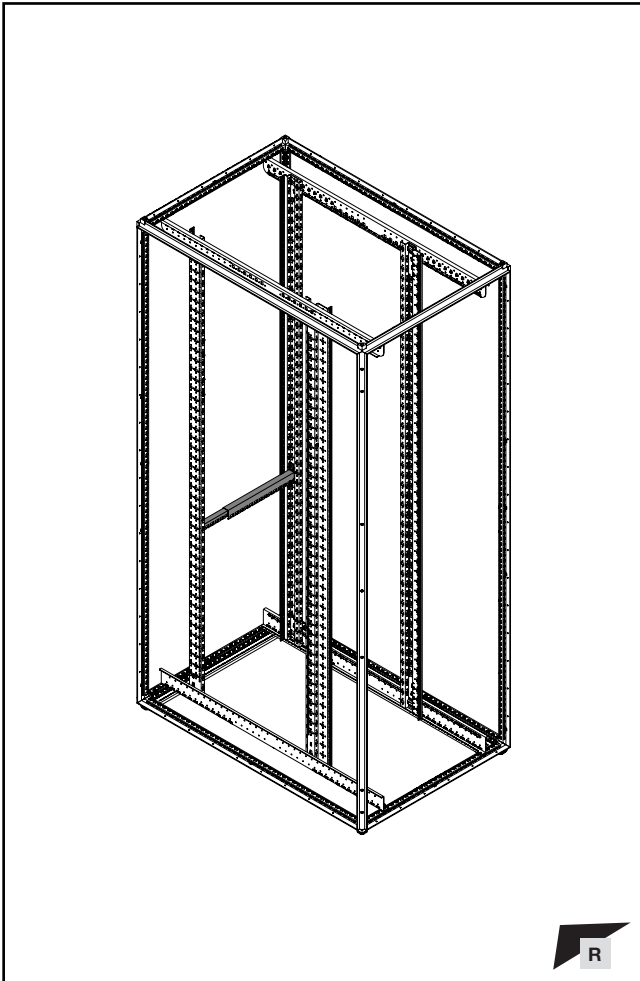

## Notizen/Notes

---

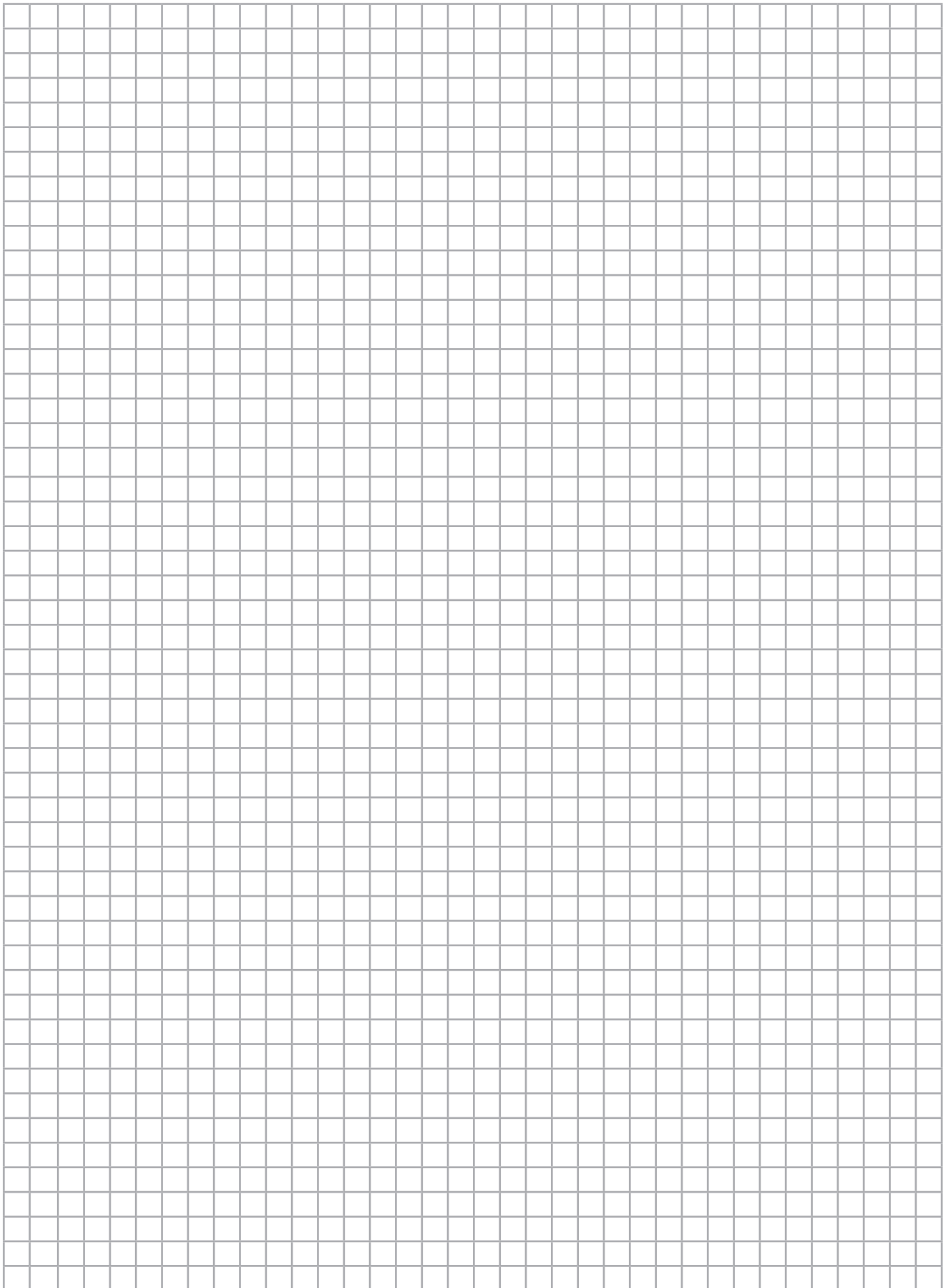

# Rittal – The System.

Faster – better – everywhere.

- Enclosures
- Power Distribution
- Climate Control
- IT Infrastructure
- Software & Services

You can find the contact details of all Rittal companies throughout the world here.



[www.rittal.com/contact](http://www.rittal.com/contact)

RITTAL GmbH & Co. KG  
Auf dem Stuetzelberg · 35745 Herborn · Germany  
Phone +49 2772 505-0  
E-mail: [info@rittal.de](mailto:info@rittal.de) · [www.rittal.com](http://www.rittal.com)

02.2020/D-0000-00002199-00

ENCLOSURES

POWER DISTRIBUTION

CLIMATE CONTROL

IT INFRASTRUCTURE

SOFTWARE & SERVICES



FRIEDHELM LOH GROUP