

**Rittal – The System.**

Faster – better – everywhere.

**Verbindungs-  
kit für getrennten  
VX Rahmen**

**Connection kit for separate  
VX frame**

**Kit de jonction pour cadre  
séparé VX**

VX IT 5302.037

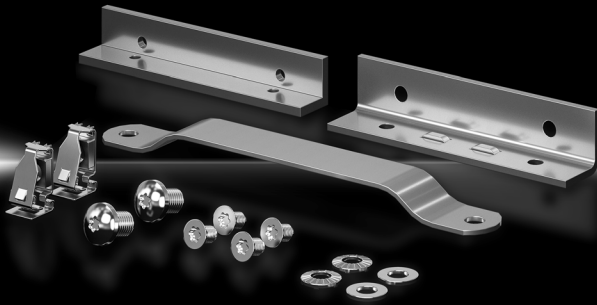

**Montageanleitung  
Assembly instructions  
Notice de montage**

ENCLOSURES

POWER DISTRIBUTION

CLIMATE CONTROL

IT INFRASTRUCTURE

SOFTWARE & SERVICES

FRIEDHELM LOH GROUP



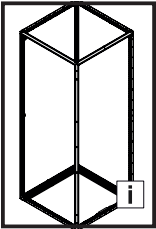

**Inhaltsverzeichnis**  
**Contents**  
**Sommaire**

DE

EN

FR

<b>1. Hinweise zur Dokumentation</b>	<b>4</b>	<b>1. Notes on documentation</b>	<b>4</b>	<b>1. Remarques relatives à la documentation</b>	<b>4</b>
1.1 Aufbewahrung der Unterlagen	4	1.1 Storing the documents	4	1.1 Conservation des documents	4
1.2 Verwendete Symbole	4	1.2 Symbols used	4	1.2 Symboles utilisés	4
1.3 Bestimmungsgemäße Verwendung	4	1.3 Intended use	4	1.3 Utilisation correcte	4
<b>2. Sicherheitshinweise</b>	<b>5 – 8</b>	<b>2. Safety instructions</b>	<b>5 – 8</b>	<b>2. Consignes de sécurité</b>	<b>5 – 8</b>
<b>3. Montage Verbindungskit</b>	<b>9 – 11</b>	<b>3. Mounting the connection kit</b>	<b>9 – 11</b>	<b>3. Montage du kit de jonction</b>	<b>9 – 11</b>
3.1 Elektrische Kontaktierung	11	3.1 Electrical contact	11	3.1 Mise en contact électrique	11

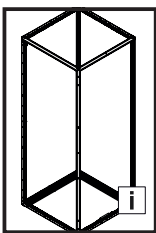

**Inhaltsverzeichnis**  
**Contents**  
**Sommaire**

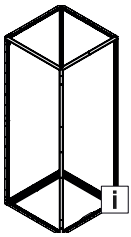

2 – 8

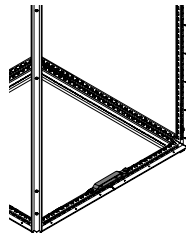

9 – 11

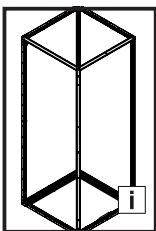

**Abkürzungsverzeichnis**  
**Table of abbreviations**  
**Répertoire des abréviations**

DE

EN





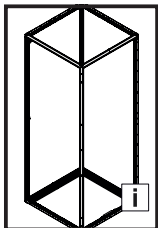

FR

– M<sub>A</sub>: Anzugsdrehmoment

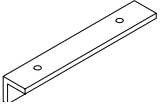
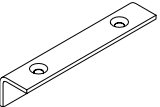
– M<sub>A</sub>: Tightening torque

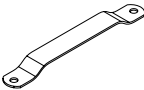
– M<sub>A</sub>: Couple de serrage



Bestell.-Nr. Model No. Référence	5302.037	
		4
		4
	M6 x 12	16
		1
	M8	2
	M8 x 16	2
	Ø 8,2	2
	Ø 8,4	2

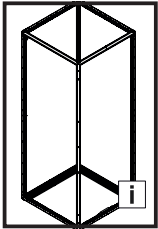

**1. Hinweise zur Dokumentation**  
**1. Notes on documentation**  
**1. Remarques relatives à la documentation**

DE

Die **Montageanleitung** richtet sich an Personen, die Einrichtungen der Informations- und Telekommunikationstechnik unter Kenntnis der länderspezifischen Sicherheitsvorschriften am Bestimmungsort aufstellen, anschließen und betreiben.

**1.1 Aufbewahrung der Unterlagen**

Die Dokumentation ist Teil des Produktes. Sie muss dem Anlagenbetreiber ausgehändigt werden. Dieser übernimmt die Aufbewahrung, damit die Unterlagen im Bedarfsfall zur Verfügung stehen.

**1.2 Verwendete Symbole**

Beachten Sie folgende Sicherheits- und sonstige Hinweise in der Anleitung:

**Sicherheits- und andere Hinweise:**



**Gefahr!**  
**Unmittelbare Gefahr für Leib und Leben.**



**Achtung!**  
**Mögliche Gefahr für Produkt und Umwelt.**



**Hinweis:**  
**Nützliche Informationen und Besonderheiten.**



**Hinweis:**  
**Front-/Rückansicht.**

EN

These **assembly instructions** have been written for personnel tasked with assembling, connecting and operating IT and telecommunications equipment at the intended location and who are familiar with the country-specific safety regulations.

**1.1 Storing the documents**

The safety notes and the accompanying note are part of the product. They must be given to the plant operator, who is then responsible for the storage of the documents so that they are readily available when needed

**1.2 Symbols used**

Please observe the following safety instructions and other notes in this guide:

**Safety and other notes:**



**Danger!**  
**Immediate danger to life and limb.**



**Caution!**  
**Potential threat to the product and its environment.**



**Note:**  
**Useful information and special features.**



**Note:**  
**Front/rear view.**

FR

La **notice de montage** s'adresse aux personnes qui installent, raccordent et exploitent les installations IT et de télécommunication, dans le respect des prescriptions de sécurité spécifiques au pays où elles sont installées.

**1.1 Conservation des documents**

Les consignes de sécurité et la notice jointe font partie du produit. Elles doivent être remises à l'exploitant de l'installation. Celui-ci les conservera de manière à ce qu'elles soient disponibles en cas de besoin.

**1.2 Symboles utilisés**

Tenir compte des consignes de sécurité et autres directives contenues dans cette notice :

**Consignes de sécurité et autres directives :**



**Danger !**  
**Risque de blessure grave, voire mortelle.**



**Attention !**  
**Danger éventuel pour le produit et l'environnement.**



**Remarque :**  
**Informations utiles et particularités.**



**Remarque :**  
**F = vue frontale**  
**R = vue arrière**

**1.3 Bestimmungsgemäße Verwendung**

Das VerbindungsKit für getrennten Rahmen dient zum Wiederausammenführen eines Rahmengerüsts, an welchem eine mechanische Trennung der Vertikal- oder Horizontalprofile durchgeführt wurde.

Die max. erreichbare IP-Schutzart des Schranksystems wird durch die Trennung des Rahmens eingeschränkt.

**1.3 Intended use**

The connection kit for separate frames is used to reconnect a frame which has had its vertical or horizontal sections mechanically separated. The maximum achievable IP protection category of the enclosure system is limited by the separation of the frame.

**1.3 Utilisation correcte**

Le kit de jonction pour cadre séparé sert à réassembler une ossature sur laquelle des profilés verticaux ou horizontaux ont été séparés.

L'indice de protection IP maximale réalisable des baies est limitée par la séparation du cadre.

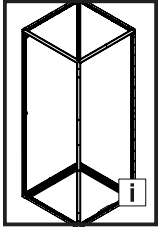

**2. Sicherheitshinweise**  
**2. Safety instructions**  
**2. Consignes de sécurité**

**2. Veiligheidsvoorschriften**  
**2. Säkerhetsinstruktioner**  
**2. Istruzioni di sicurezza**

**2. Instrucciones de seguridad**

	DE	EN	FR	NL	SE	IT	ES
	Warnung vor der Schließbewegung von mechanischen Teilen einer Maschine/Einrichtung	Warning against closing movements for mechanical parts of a machine/device	Danger dû à la fermeture de pièces mécaniques d'une machine / installation	Waarschuwing voor de sluitbeweging van mechanische onderdelen van een machine/voorziening	Varning för stängningsrörelse på mekaniska delar i en maskin/enhet	Prestare attenzione alla chiusura delle parti meccaniche di una macchina o di un dispositivo	Atención, movimiento de cierre de componentes mecánicos en una máquina/instalación
	Warnung vor sich bewegenden mechanischen Teilen	Warning against independently moving parts	Danger dû à des pièces mécaniques mobiles	Waarschuwing voor bewegende mechanische onderdelen	Varning för rörliga mekaniska delar	Prestare attenzione alle parti meccaniche in movimento	Atención, componentes mecánicos en movimiento
	Warnung vor Umkippen durch Schwerpunktverlagerung	Risk of tipping due to displacement of centre of gravity	Attention au basculement lors du déplacement du centre de gravité	Waarschuwing voor kantelen als gevolg van zwaartepuntverschuiving	Varning för vältande föremål på grund av förskjutet tyngdpunkt	Pericolo di cadute tramite lo spostamento del baricentro	Advertencia de vuelco si se desplaza el centro de gravedad
	Warnung vor spitzem Gegenstand	Caution: Sharp object	Attention aux objets pointus	Waarschuwing voor scherpe voorwerpen	Varning för vassa föremål	Pericolo oggetto affilato	Advertencia de objetos puntiagudos
	Warnung vor Hindernissen am Boden	Caution: Obstructions on floor	Attention aux obstacles au sol	Waarschuwing voor obstakels op de grond	Varning för hinder på marken	Pericolo ostacolo in basso	Advertencia de obstáculos en el suelo
	Warnung vor schweren Lasten	Caution: Heavy loads	Attention aux charges lourdes	Waarschuwing voor zware belastingen	Varning för tung last	Pericolo carichi pesanti	Advertencia de cargas pesadas
	Warnung vor Hindernissen im Kopfbereich	Caution: Obstructions in head area	Attention aux obstacles au niveau de la tête	Waarschuwing voor obstakels op hoofdhoogte	Varning för hinder i huvudhöjd	Pericolo ostacolo in alto	Advertencia de obstáculos en la zona de la cabeza
	Die Anleitung ist zu lesen	The instructions must be read	La notice doit être lue	Lees de gebruiksaanwijzing	Bruksanvisningen måste läsas	Leggere le istruzioni	Leer el manual de instrucciones
	Installation durch Mechanik-Fachkraft	Installation by specialist mechanics	Installation par un mécanicien confirmé	Installatie door monteur	Ska installeras av behörig montör	L'installazione deve essere eseguita da un meccanico qualificato	Instalación a realizar por un técnico mecánico cualificado

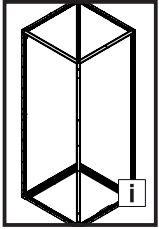

**2. Turvallisuusohjeet**  
**2. Sikkerhedsanvisninger**  
**2. Wskazówki dotyczące bezpieczeństwa**

**2. Bezpečnostní pokyny**  
**2. Инструкции за безопасност**  
**2. Меры безопасности**

	FI	DK	PL	CZ	BG	RU
	Varoitus koneen/laitteen mekaanisten osien sulkuliikkeestä	Advarsel mod lukkebevægelse af mekaniske dele i en maskine/indretning	Uwaga na zamykające się części mechaniczne maszyny lub urządzenia	Výstraha před rizikem úrazu ruky	Предупреждение за движение от затварящи се механични части на машина/оборудване	Предупреждение об опасности при закрывании механических частей машины/установки
	Varoitus liikkuvista mekaanisista osista	Advarsel mod uafhængigt bevægelige dele	Uwaga na ruchome części mechaniczne	Výstraha; Rozmačkání	Предупреждение за движещи се механични части	Предупреждение об опасности движущихся механических частей
	Varo: painopisteen siirtymisestä johtuva kaatumisvaara	Risiko for væltning på grund af forskydning af tyngdepunktet	Ostrzeżenie przed przewróceniem się z powodu przesunięcia środka ciężkości	Varování před převrácením způsobeným posunutím těžiště	Предупреждение за опасност от преобръщане поради изместване на центъра на тежестта	Предупреждение об опрокидывании ввиду смещения центра тяжести
	Varo teräviä reunoja	Advarsel: Spidse genstande	Ostrzeżenie przed ostrym przedmiotem	Varování před ostrým předmětem	Предупреждение за опасност от остър предмет	Предупреждение об остром предмете
	Varo: kompastumisvaara	Advarsel: Forhindringer på gulvet	Ostrzeżenie przed przeszkodami na podłożu	Varování před překážkami na zemi	Предупреждение за опасност от препятствия по земята	Предупреждение о препятствиях на полу
	Varo raskasta kuormaa	Advarsel: Tunge belastninger	Ostrzeżenie przed dużymi ciężarami	Varování před těžkými břemeny	Предупреждение за опасност от тежки товари	Предупреждение о тяжелых грузах
	Varo putoavia esineitä	Advarsel: Forhindringer i hovedhøjde	Ostrzeżenie przed przeszkodami w pobliżu głowy	Varování před překážkami v oblasti hlavy	Предупреждение за опасност от препятствия в областта около главата	Предупреждение в препятствиях в верхней области головы
	Lue käyttöohjeet	Vejledningen skal læses	Przeczytać instrukcję	Odkaz na instrukce návodu k použití/brožury	Прочетете ръководството	Прочитать руководство
	Asennuksen saa suorittaa vain mekaniikka-alan ammattilainen	Skal installeres af uddannet mekaniker	Instalacja przez mechanika	Instalace odborným mechanikem	Монтажът се извършва от механик	Установка силами специалистов по механике

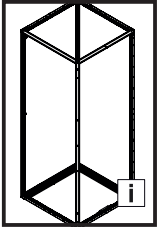

**2. Υποδείξεις ασφαλείας**  
**2. Instrucțiuni de siguranță**  
**2. Sigurnosne upute**







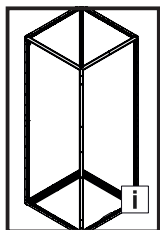

**2. Biztonsági utasítások**  
**2. Saugos nurodymai**  
**2. Ohutusjuhised**

**2. Drošības norādījumi**

	GR	RO	HR	HU	LT	EE	LV
	Προειδοποίηση πριν από την κίνηση κλειδώματος μηχανικών μερών μίας εγκατάστασης/μηχανήματος	Avertizare cu privire la mișcarea de închidere a pieselor mecanice ale unei mașini/ale unui dispozitiv	Upozorenje na opasnost od uklještenja mehaničkih dijelova stroja/uređaja	Gép/berendezés mechanikai részekre történő figyelmeztetés	Įspėjimas dėl mašinos / įrenginio mechaninių dalių judėjimo, užsidarymo metu	Hoiatus masina/ seadme mehhaaniliste osade sulgemisliikumise eest	Uzmanieties iekārtas/mašīnas mehānisko daļu aizvēršanās laikā
	Προειδοποίηση από κινούμενα μηχανικά μέρη	Avertisment cu privire la piesele mecanice aflate în mișcare	Upozorenje na mehaničke dijelove koji su u pokretu	Mozgó mechanikai részekre történő figyelmeztetés	Įspėjimas dėl judančių mechaninių dalių	Hoiatus liikuvate mehhaaniliste osade eest	Uzmanieties no kustīgām mehāniskām daļām
	Προειδοποίηση ανατροπής λόγω μετατόπισης του κέντρου βάρους	Avertizare de răsturnare prin deplasarea centrului de greutate	Upozorenje na prevrtanje zbog pomicanja težišta	Figyelmeztetés a feldőlés veszélyére a súlypont eltolódása miatt	Įspėjimas apie galimą apvirtimą dėl svorio centro perkėlimo	Hoiatus ümberkukkumise eest raskuskeskme nihkumise tõttu	Brīdinājums par apgāšanos smaguma centra novirzīšanās dēļ
	Προειδοποίηση αιχμηρού αντικειμένου	Avertizare privind obiecte ascuțite	Upozorenje na šiljati predmet	Figyelmeztetés hegyes tárgyak veszélyére	Įspėjimas apie aštrų daiktą	Hoiatus terava eseme eest	Brīdinājums par asiēm priekšmetiem
	Προειδοποίηση για εμπόδια στο έδαφος	Avertizare privind obstacole la sol	Upozorenje na zapreke na tlu	Figyelmeztetés a padlón található akadályokra	Įspėjimas apie kliūtis ant žemės	Hoiatus põrandal asuvate takistuste eest	Brīdinājums par šķēršļiem uz grīdas
	Προειδοποίηση για βαριά φορτία	Avertizare privind sarcini grele	Upozorenje na teške terete	Figyelmeztetés nehéz teherre	Įspėjimas apie sunkius krovinius	Hoiatus raskete koormate eest	Brīdinājums par lielu slodzi
	Προειδοποίηση για εμπόδια στην περιοχή της κεφαλής	Avertizare privind obstacole în zona capului	Upozorenje na zapreke u području glave	Figyelmeztetés fejmagasságban található akadályokra	Įspėjimas apie kliūtis galvos aukštyje	Hoiatus pea piirkonnas asuvate takistuste eest	Brīdinājums par šķēršļiem galvas zonā
	Απαιτείται το διάβασμα των οδηγιών	A se citi manualul	Pročitajte upute	Az utasítást el kell olvasni	Skaityti instrukciją	Lugeda kasutusjuhendit	Izlasiet instrukciju
	Εγκατάσταση από εκπαιδευμένο μηχανικό	Instalarea se va face de un mecanic calificat	Instalaciju smije provesti samo ovlašteno stručno osoblje za mehaničarske radove	A szerelését mechanikus szakembernek kell elvégeznie	Turi įrengti mechanikas	Kvalifitseeritud mehhaaniku poolne paigaldamine	Uzstādīšanu drīkst veikt tikai kvalificēts mehāniķis



## 2. Varnostni napotki 2. Bezpečnostné pokyny 2. Instruções de segurança

	SI	SK	PT
	Opozorilo pred zapiranjem mehanskih delov stroja/naprave	Dávajte pozor na zatvárací pohyb mechanických častí stroja/zariadenia	Cuidado quando as partes mecânicas de uma máquina/instalação se fecham
	Opozorilo pred premikajočimi se mehanskimi deli	Dávajte pozor na pohyblivé mechanické časti	Cuidado com as partes mecânicas móveis
	Opozorilo pred prevrnitvijo zaradi spremenjenega težišča	Varovanie pred prevrátením v dôsledku premenenia ťažiska	Cuidado com o risco de queda pelo deslocamento do centro de gravidade
	Opozorilo pred ostrim predmetom	Varovanie pred predmetom s ostrým hrotom	Cuidado com objetos pontiagudos
	Opozorilo pred ovirami na tleh	Varovanie pred prekážkami na podlahe	Cuidado com objetos no chão
	Opozorilo pred težkimi bremenami	Varovanie pred ťažkými bremenami	Cuidado com cargas pesadas
	Opozorilo pred ovirami v višini glave	Varovanie pred prekážkami v priestore hlavy	Cuidado com objeto à altura da cabeça
	Preberite navodila	Prečítajte si návod	Ler as instruções
	Namestitev lahko izvajajo samo usposobljeni strokovnjaki za mehanična dela	Inštaláciu smie vykonávať len špecializovaný mechanik	A instalação deve ser feita por um técnico mecânico especializado



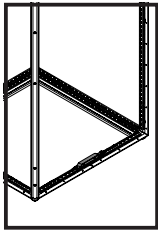

3. Montage Verbindungs-  
3. Mounting the connection  
3. Montage du kit de jonction

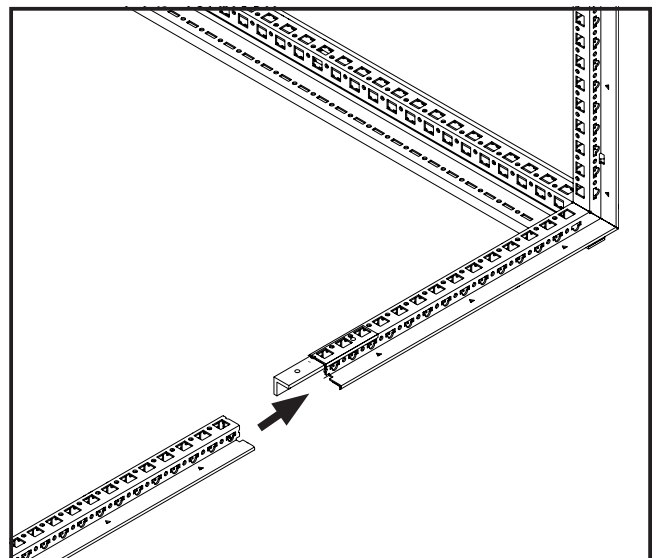
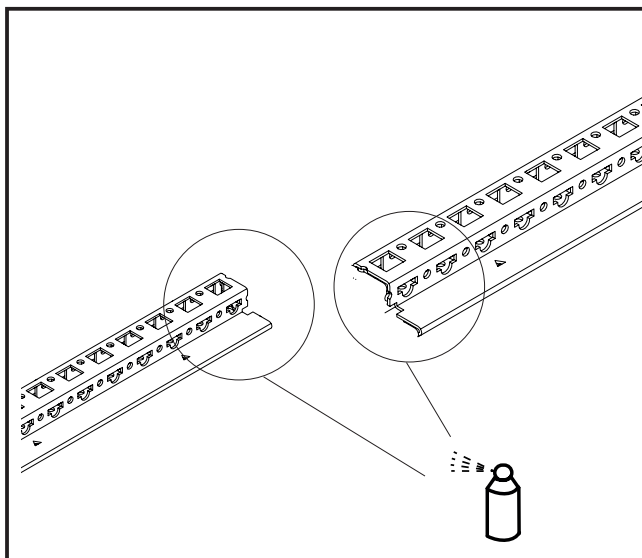
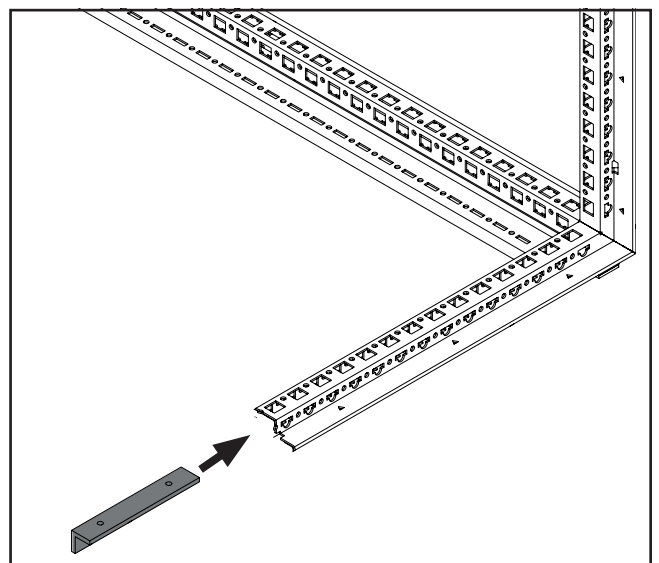
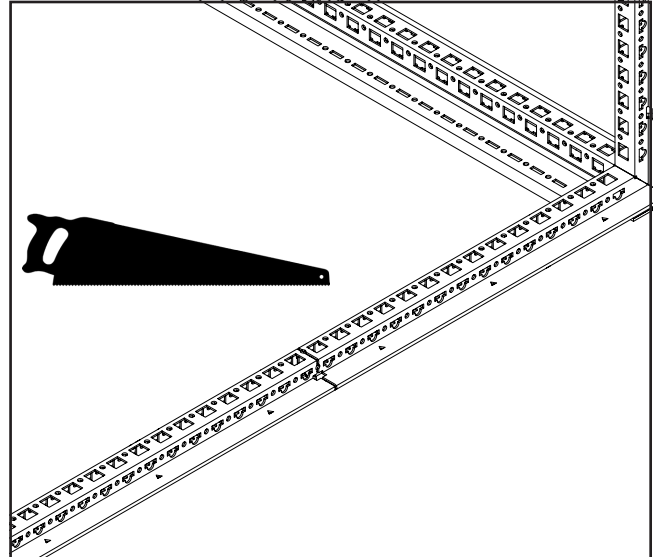
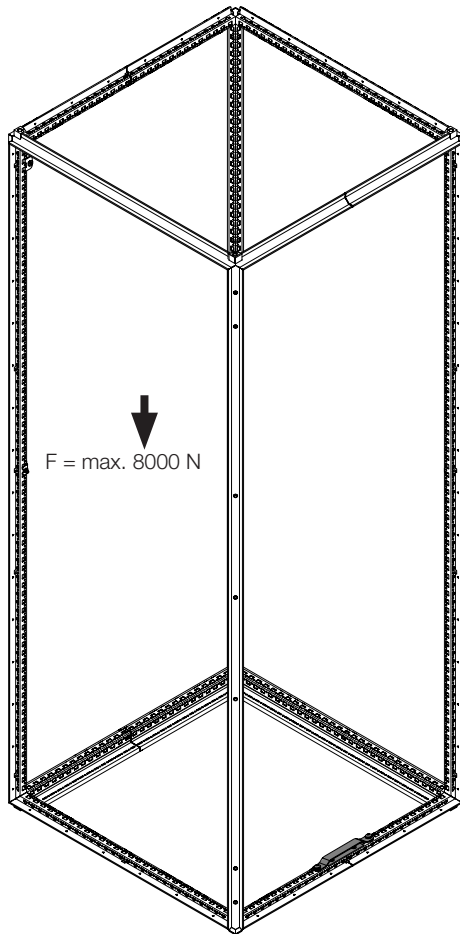

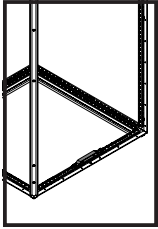

TX30



DE EN FR

3. Montage Verbindungs-  
3. Mounting the connection kit  
3. Montage du kit de jonction

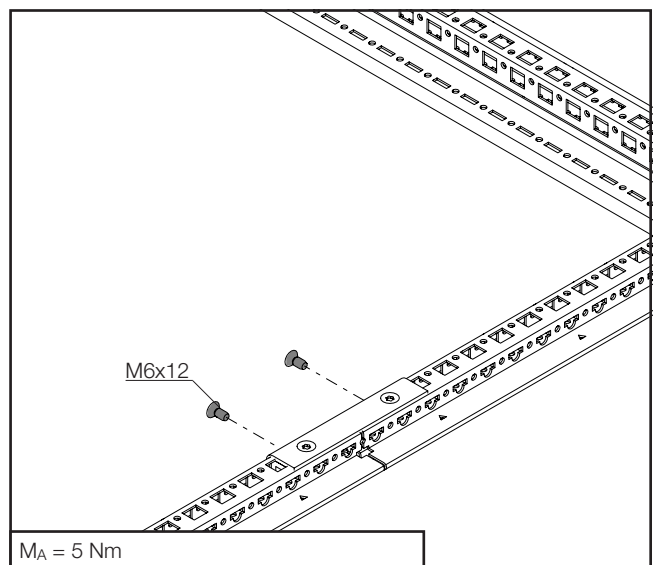
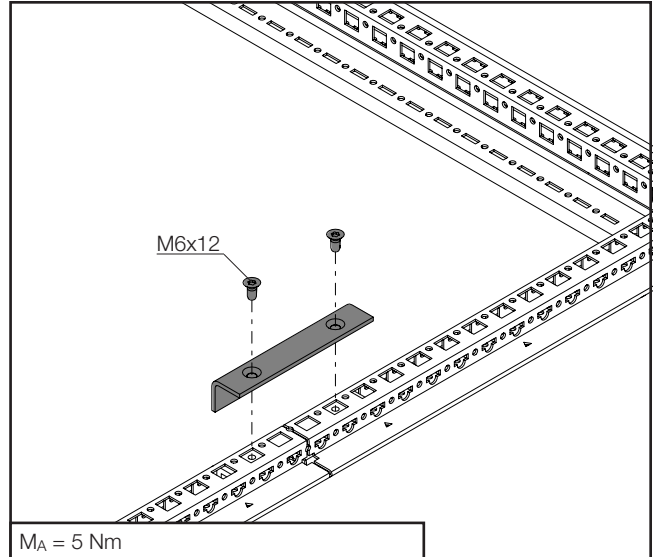
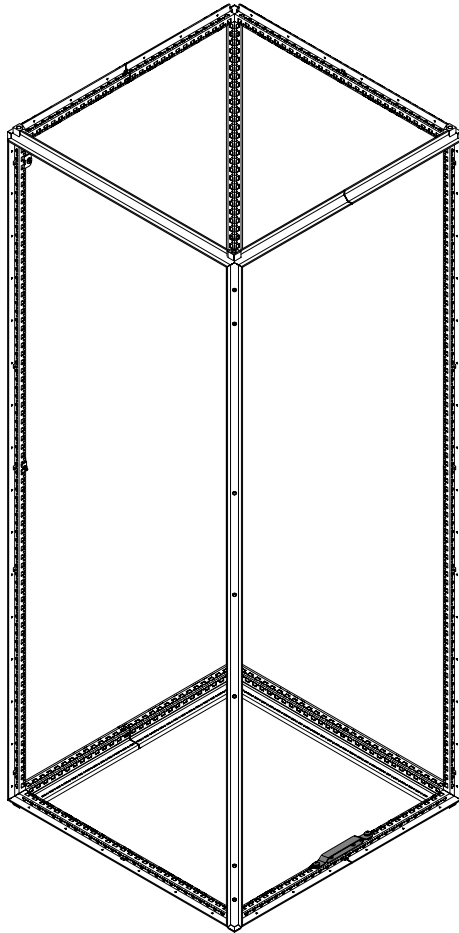

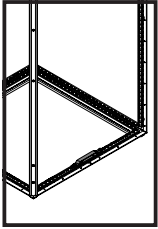

TX40



DE EN FR

### 3. Montage Verbindungs- kit 3. Mounting the connection kit 3. Montage du kit de jonction

#### 3.1 Elektrische Kontaktierung 3.1 Electrical contact 3.1 Mise en contact électrique

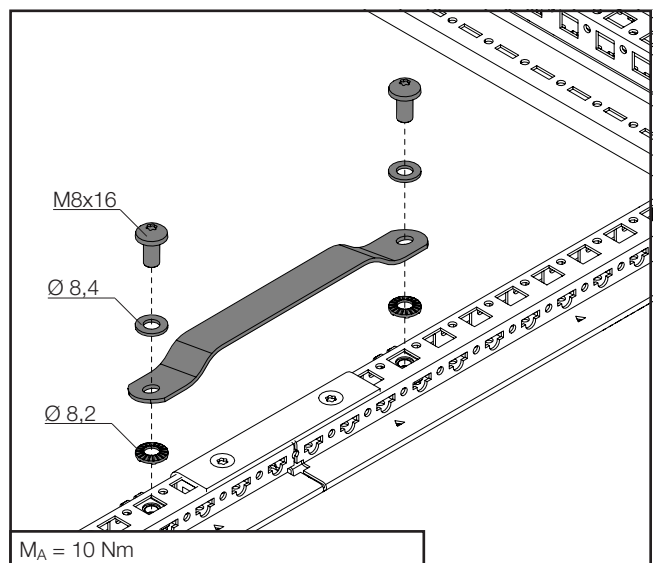
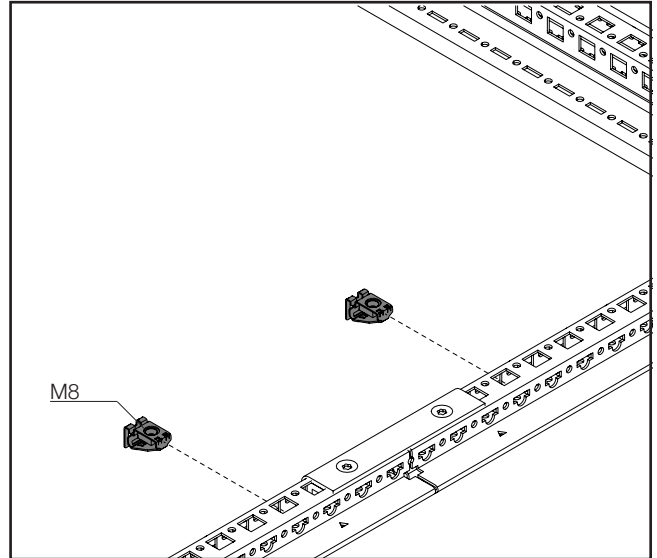
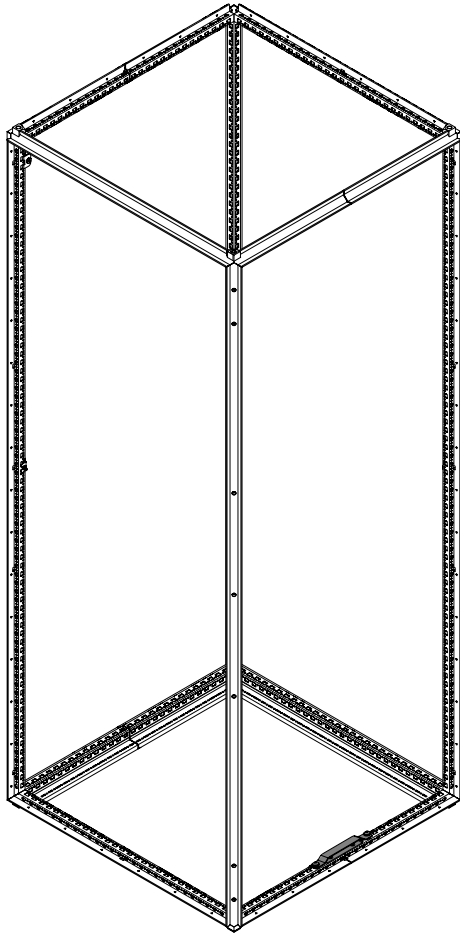

# Rittal – The System.

Faster – better – everywhere.

- Enclosures
- Power Distribution
- Climate Control
- IT Infrastructure
- Software & Services

You can find the contact details of all Rittal companies throughout the world here.



[www.rittal.com/contact](http://www.rittal.com/contact)

RITTAL GmbH & Co. KG  
Auf dem Stuetzelberg · 35745 Herborn · Germany  
Phone +49 2772 505-0  
E-mail: [info@rittal.de](mailto:info@rittal.de) · [www.rittal.com](http://www.rittal.com)

03.2020/D-0000-00002289-00

ENCLOSURES

POWER DISTRIBUTION

CLIMATE CONTROL

IT INFRASTRUCTURE

SOFTWARE & SERVICES

FRIEDHELM LOH GROUP

