

Endüstriyel panolar

Pano sistemleri

VX25 modüler pano sistemi

Dağıtım kabini

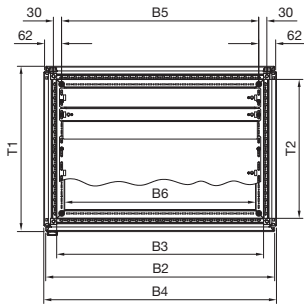
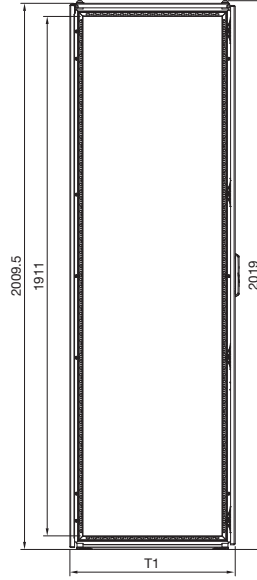
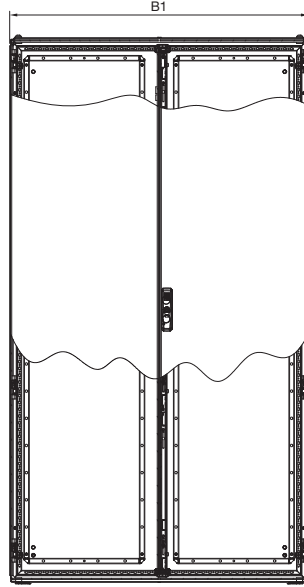
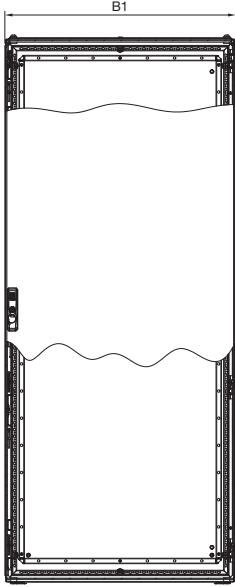

Profil

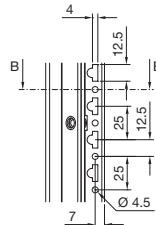
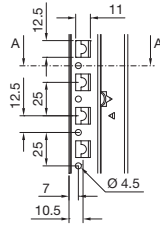

Kesit A - A

Kesit B - B

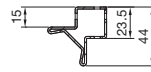
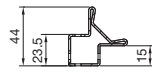

- B1 = Toplam genişlik
- B2 = Arka panel genişliği
- B3 = Pano çerçevesi iç ölçüsü
- B4 = Yan panellerle birlikte genişlik
- B5 = Taban/baza sabitlemesi delik aralığı
- B6 = Taban deliği açık iç ölçüsü
- T1 = Arka ve yan panellerle birlikte toplam derinlik
- T2 = Pano çerçevesi iç ölçüsü

Sip. No.	Genişlik ölçüleri mm						Derinlik ölçüleri mm	
	B1	B2	B3	B4	B5	B6	T1	T2
9666.916	849	842	761	856	725	702	608	511
9666.926	1099	1092	1011	1106	975	952	608	511
9666.956	849	842	761	856	725	702	408	311
9666.966	1099	1092	1011	1106	975	952	408	311