

Rittal – The System.

Faster – better – everywhere.

Schaltschrank-Kühlgerät
Enclosure cooling unit
Climatiseur pour armoires électriques



SK 3185830
SK 3186930
SK 3187930
SK 3188940
SK 3189940

SK 3185530
SK 3186630
SK 3187630
SK 3188640
SK 3189640

Montage- und Installationsanleitung
Assembly and installation instructions
Notice de montage et d'installation

ENCLOSURES

POWER DISTRIBUTION

CLIMATE CONTROL

IT INFRASTRUCTURE

SOFTWARE & SERVICES



FRIEDHELM LOH GROUP

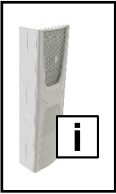

Downloadmöglichkeiten / Download options / Possibilités de téléchargement
Rittal Blue e+ enclosure cooling units



Hinweis:
Die Montage-, Installations- und Bedienungsanleitung ist auch als Download unter www.rittal.de verfügbar.



Nota:
As instruções operacionais e de montagem estão disponíveis para download em www.rittal.com.



Note:
The assembly and operating instructions are available for downloading from www.rittal.com.



Wskazówka:
Instrukcja montażu, instalacji i obsługi do pobrania na www.rittal.pl.



Remarque :
La notice de montage, d'installation et d'emploi peut être téléchargée depuis le site www.rittal.fr.



Upozornění:
Návody k montáži a obsluze jsou k dispozici ke stažení na www.rittal.cz.



Opmerking:
De montage-, installatie- en gebruikshandleiding is ook te downloaden via www.rittal.nl.



Указание:
Руководство по монтажу, установке и эксплуатации можно найти на сайте www.rittal.ru.



Obs:
Montage-, installations- och bruksanvisningen kan även laddas ner på www.rittal.se.



提示：
装配和操作说明可从 www.rittal.cn 下载。



Nota:
Le istruzioni di montaggio, installazione e uso possono anche essere scaricate dal sito www.rittal.it.



注記：
この取扱説明書（組立・設置および運用マニュアル）は、www.rittal.co.jp からダウンロードできます。



Nota:
Las instrucciones de montaje, instalación y puesta en marcha también están disponibles para su descarga en www.rittal.es.

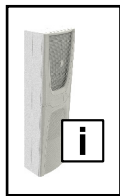

Warn- und Sicherheitshinweise / Safety instructions and warnings / Consignes de sécurité
Rittal Blue e+ enclosure cooling units

Hazards and their prevention according to IEC 60417/ISO 7000/ISO 7010



DE Die Anschlussvorschriften des zuständigen Stromversorgungsunternehmens sind zu beachten. Der Schutzleiter, der Haube und Chassis verbindet, muss in jedem Fall an beiden Steckern angeschlossen werden. Ansonsten besteht bei einem fehlerhaftem oder defekten Anschluss des Geräts Verletzungsgefahr durch Stromschlag.

EN The connection regulations of the appropriate power supply company are to be followed. The protective conductor between the hood and the frame must always be attached to both plug connectors. Otherwise, there is risk of injury from electric shock if the connection to the unit is defective or connected incorrectly in any way.

FR Respecter les directives de raccordement du fournisseur d'électricité compétent. La tresse de mise à la masse qui relie le capot au châssis doit dans tous les cas être raccordée aux deux fiches. Sinon il y a risque de blessure par électrocution en cas de raccordement erroné ou défectueux de l'appareil.

NL Neem de aansluitvoorschriften van het desbetreffende energiebedrijf in acht. De aarddraad, die de kap en het chassis verbindt, dient in elk geval op beide connectoren te worden aangesloten. Anders bestaat bij een onjuiste of defecte aansluiting van het apparaat een risico op letsel door een elektrische schok.

SE Anslutningsföreskrifterna från det ansvariga elförsörjningsföretaget måste följas. Skyddsledaren som förbinder huven och chassit måste alltid vara ansluten till båda kontakterna. Annars finns risk för skador genom strömstötar vid felaktig eller defekt anslutning av aggregatet.

IT Osservare le prescrizioni relative al collegamento dell'azienda fornitrice di elettricità competente. Il conduttore di protezione che collega la copertura al telaio deve essere sempre collegato su entrambe le estremità. In caso di collegamento assente o errato del dispositivo vi è il pericolo di lesioni dovute a scossa elettrica.

ES Deben tenerse en cuenta las normas del reglamento electrotécnico de baja tensión. El conductor de protección, que conecta la cubierta y el chasis, debe estar siempre conectado a ambos conectores. En caso contrario, con una conexión errónea o defectuosa del aparato, existe un peligro de lesión por descarga eléctrica.

FI Huomioi energiayhtiön liitäntäohjeet. Muussa tapauksessa laitteen virheellinen tai viallinen liitäntä saattaa aiheuttaa sähköiskusta johduvan loukkaantumisaaran.

DK Følg altid tilslutningsvejledningen fra det ansvarlige elseskab. Beskyttelseslederen, som forbinder dækslet med chassiset, skal altid være tilsluttet i begge stik. Hvis ikke dette er tilfældet, er der risiko for at få elektrisk stød som følge af forkert eller defekt tilslutning af enheden.

IE Ní mór rialacháin nasctha na cuideachta cuí a sholáthraíonn an chumhacht a leanúint. Ní mór go mbeadh an seoltóir cosanta idir an cochall agus an fráma nasctha leis an dá nascóir plocóide. Mura mbíonn, tá baol gortaithe ó thurraing leictreach má tá an nasc leis an aonad lochtach nó má tá sé nasctha ar cearr ar bhealach ar bith.

PT Seguir as orientações da respectiva empresa de fornecimento de energia elétrica. O condutor de proteção que interliga a cobertura com o chassi deve estar sempre conectado em ambas as extremidades. Caso contrário, haverá risco de choque elétrico se a conexão do aparelho apresentar falha ou estiver incorreta.

HR Potrebno je pridržavati se pravila o priključivanju odgovarajućeg napona isporučitelja električne energije. Zaštitno uzemljenje između poklopca i okvira mora uvijek s biti spojeno na priključne točke poklopca i okvira. Ukoliko zaštitno uzemljenje nije propisno spojeno ili je oštećeno, postoji opasnost od ozljeda uzrokovanih strujnim udarom.

MT Għandhom jġu osservati r-rewkwiżiti tat-tqabbid tal-kumpanija tal-provvista tal-elettriku lokali. Il-konduttur protettiv li jgħabba il-hood max-xażi għandu jkun imqabbad dejjem biż-żewġ plugs. Inkella jkun hemm ir-riskju ta' xokk elettriku jekk ikun hemm konnessjoni mhux tajba jew difettuża.

PL Przestrzegać przepisów odpowiedniego Zakładu Energetycznego. Przewód ochronny łączący pokrywę z obudową musi być zawsze podłączony z obu stron. W przeciwnym razie, w przypadku błędnego lub wadliwego podłączenia urządzenia, istnieje niebezpieczeństwo porażenia prądem elektrycznym.

CZ Dodržujte předpisy příslušného dodavatele elektrické energie pro připojení elektrického zařízení. V každém případě musí být připojeny oba konektory ochranného vodiče, který spojuje přední plášť jednotky a její rám. Jinak hrozí při chybném nebo vadném připojení přístroje nebezpečí úrazu elektrickým proudem.

BG Трябва да се спазват предписанията за свързване към захранването на компетентното електроснабдително дружество. Заземяващият проводник, който свързва капака и рамата, във всички случаи трябва да се свърже към двата конектора. В противен случай съществува опасност от нараняване вследствие на токов удар в случай на неправилно или неизправно свързване на уреда или неизправна електрическа мрежа.

GR Πρέπει να τηρούνται οι κανονισμοί σύνδεσης της σχετικής εταιρείας παροχής ηλεκτρικού ρεύματος. Ο προστατευτικός αγωγός μεταξύ του καλύμματος και του πλαισίου πρέπει να συνδέεται πάντα και στις δύο υποδοχές βύσματος. Σε αντίθετη περίπτωση, υπάρχει κίνδυνος τραυματισμού από ηλεκτροπληξία εάν η σύνδεση της μονάδας είναι ελαττωματική ή εσφαλμένη.

RO Trebuie respectate cerințele de racordare ale companiei locale de alimentare cu energie. Conductorul de protecție dintre capac și carcasa trebuie să fie conectat întotdeauna la ambele prize. În cazul în care conexiunea aparatului este incorectă sau defectuoasă, există pericol de rănire prin electrocutare.

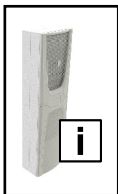

Warn- und Sicherheitshinweise / Safety instructions and warnings / Consignes de sécurité
Rittal Blue e+ enclosure cooling units

Hazards and their prevention according to IEC 60417/ISO 7000/ISO 7010

HU Az illetékes áramszolgáltató csatlakoztatási előírásait figyelembe kell venni. A burkolatot és a vázat összekötő védővezetéket minden esetben mindkét csatlakozóhoz csatlakoztatni kell. Ellenkező esetben, a berendezés hibás vagy meghibásodott csatlakoztatása esetén áramütés veszélye áll fenn.

LT Privalu laikytis atsakingos elektros tiekimo tinklų bendrovės parengtų instrukcijų. Apsauginis laidininkas, jungiantis gaubtą ir korpusą, visada turi būti prijungtas prie abiejų jungčių. Įrenginio jungties pažeidimo ar defekto atveju kyla pavojus susižaloti gavus elektros smūgį.

EE Järgige vastutava elektrivarustuse ettevõtte vooluvõrku ühendamise eeskirju. Juhtkaitse, mis ühendab katet ja alusraami, peab igal juhul olema mõlemast pistikust ühendatud. Vastasel korral tekib seadme puudulikul või defektisel ühendamisel vigastusoht elektrilöögi tõttu.

LV Ievērojiet izmantotā elektropiegādes uzņēmuma pieslēguma noteikumus. Starp pārsegu un rāmi esošajam nulles vadam vienmēr ir jābūt pievienotam abiem elektriskajiem spraudņiem. Pretējā gadījumā, ja iekārtas savienojumā ir radusies kļūme vai ja tā ir pieslēgta nepareizi, pastāv risks ciest no elektriskās strāvas trieciena.

SI Upoštevati je treba predpise za priključevanje naprav pristojnega podjetja za distribucijo električne energije. Ozemljitveni priključek, ki povezuje pokrov in ohišje, je treba v vsakem primeru namestiti na oba vtiča. V nasprotnem primeru pri napačni priključitvi ali kvarjenem priključku obstaja nevarnost nastanka poškodb zaradi električnega udara.

SK Treba dbať na predpisy príslušného dodávateľa elektrickej energie týkajúce sa zapojenia. Ochranný vodič, ktorý spája kryt a spodnú časť zariadenia, musí byť v každom prípade zapojený do oboch zásuviek. V opačnom prípade hrozí pri chybnom alebo nedostatočnom zapojení zariadenia nebezpečenstvo úrazu elektrickým prúdom.

RU Необходимо соблюдать указания по подключению от компетентного энергопредприятия. Провод заземления, соединяющий кожух и основание, должен быть обязательно подключен с двух сторон. В противном случае при отсутствующем или поврежденном подключении имеется опасность поражения током.



DE Bitte beachten Sie die maximal zulässigen Hebegewichte für Personen. Ggf. ist eine Hebevorrichtung zu verwenden.

EN Please observe the maximum permissible weight to be lifted by one person. Use suitable lifting devices, if needed.

FR Veuillez tenir compte du poids de levage maximal autorisé pour les personnes et le cas échéant utilisez un appareil de levage.

NL Neem het maximaal toegestane tilgewicht voor personen in acht. Gebruik eventueel een hefwerktuig.

SE Observera de maximalt tillåtna lyftvikterna för personer. Vid behov ska en lyftanordning användas.

IT Prestare attenzione ai carichi massimi consentiti per le persone. Se necessario, utilizzare un dispositivo di sollevamento.

ES Rogamos tenga en cuenta el peso máximo permitido que puede levantar una persona. En caso necesario deberá utilizarse un dispositivo de elevación.

FI Huomioi sallittu enimmäisnostopaino. Käytä tarvittaessa nostolaitetta.

DK Overhold den maksimalt tilladte løftevægt for personer. Brug en løfteanordning, hvis vægten overskrider den tilladte løftevægt.

IE Cloígh leis an uasmhéachán is ceadmhach do dhuine amháin a chrochadh. Úsáid gairis ardaíthe atá oiriúnach, más gá.

PT Por favor, considere o peso máximo permitido a ser levantado por uma pessoa. Caso necessário, utilize o equipamento adequado.

HR Obratite pažnju na najveću dopuštenu masu koju smije podizati jedna osoba. Ako je potrebno, preporuča se upotreba opreme za podizanje i premještanje.

MT Jekk jogħġbok innota l-piżijiet ta' rfiġ massimi permessibbli għan-nies. Jekk ikun hemm bżonn, jeħtieġ li jintuża apparat tal-irfiġ.

PL Prosimy o nieprzekraczanie maksymalnych dopuszczalnych ciężarów podnoszonych przez ludzi. W razie potrzeby należy zastosować urządzenie podnośnikowe.

CZ Dodržujte maximální přípustné hmotnosti zvedaných břemen stanovené pro osoby. Případně použijte zvedací zařízení.

BG Спазвайте максимално допустимата товароносимост на човек при транспортиране на охладителя. Ако се налага, използвайте подемно устройство.

GR Παρακαλούμε τηρείτε το μέγιστο επιτρεπόμενο βάρος που μπορεί να αρθεί από ένα άτομο. Χρησιμοποιήστε κατάλληλες συσκευές ανύψωσης, εάν είναι απαραίτητο.

RO Respectați greutatea de ridicare maxim admisă pentru o persoană. Dacă este necesar, utilizați dispozitive de ridicare.

HU Vegye figyelembe az egy személy számára maximálisan megengedett emelhető tömegeket. Szükség esetén emelőberendezést kell használni.

LT Žmonės neturėtų kelti pernelyg sunkaus svorio. Prireikus reikia naudoti kėlimo įrangą.

EE Arvestage inimestele maksimaalselt lubatud tõstekaaludega. Vajaduse korral kasutage tõsteseadeldist.

LV Lūdzu, ievērojiet ierobežojumus attiecībā uz maksimālo svaru, ko ļauns celt vienai personai. Izmantojiet atbilstošas celšanas ierīces, kad tas ir nepieciešams.

SI Upoštevajte največjo dovoljeno težo, ki jo oseba lahko varno dvigne. Po potrebi uporabite dvizno napravo.

SK Dodržiavajte maximálne limity pre osoby na zdvíhanie bremien. V prípade prekročenia tohto limitu použite zdvíhacie zariadenie.

RU При транспортировке вручную обращайтесь внимание на максимально допустимый вес. При необходимости используйте подъемное устройство.

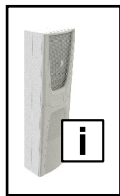

Warn- und Sicherheitshinweise / Safety instructions and warnings / Consignes de sécurité
Rittal Blue e+ enclosure cooling units

Hazards and their prevention according to IEC 60417/ISO 7000/ISO 7010



DE Das Kühlgerät ist nur standsicher, solange Haube und Chassis miteinander verbunden sind. Sichern Sie daher insbesondere das Chassis gegen Umfallen, bevor Sie die Haube abnehmen.

EN The cooling unit only stands safely while the hood and chassis are joined to each other. Ensure that the frame, in particular, is secured against tipping before removing the hood.

FR Le climatiseur est stable uniquement si le capot et le châssis sont reliés entre eux. S'assurer pour cela que le châssis ne puisse pas tomber avant d'ôter le capot.

NL Het koelaggregaat is alleen stabiel zo lang kap en chassis met elkaar zijn verbonden. Zorg er daarom voor dat als u de kap verwijdert, het chassis niet kan omvallen.

SE Kylaggregatet står endast stabilt så länge huven och chassit är förbundna med varandra. Säkra därför framför allt chassit så att det inte välter, innan du tar av huven.

IT Il condizionatore è stabile solo se la copertura e il telaio sono collegati tra loro. Mettere pertanto il telaio in sicurezza da eventuali cadute prima di rimuovere la copertura.

ES El refrigerador sólo se encuentra suficientemente estable, cuando la cubierta y el chasis se encuentran conectados el uno con el otro. Por este motivo es importante proteger especialmente el chasis de una caída, antes de retirar la cubierta.

FI Jäähdytín on vakaa vain, kun kehikko ja runko on kiinnitetty toisiinsa. Tue erityisesti runko kaatumisen varalta ennen suojuksen irrottamista.

DK Køleenheden står kun sikkert fast, hvis dækslet og chassiset er forbundet med hinanden. Sørg derfor for at sikre chassiset, så det ikke vælter, før dækslet tages af.

IE Ní bhíonn an t-aonad fuaraithe ina sheasamh go sábháilte ach amháin nuair atá an cochall agus an fonnadh nasctha le chéile. Cinntigh go ndaingnítear an fráma, go háirithe, sula mbaintear an cochall de, sa chaoi nach n-iompóidh sé.

PT O condicionador de ar estará fixo apenas quando a cobertura estiver conectada ao chassi. Antes de remover a cobertura, certificar-se de que o chassi esteja seguro e não possa tombar.

HR Rashladna jedinica stoji sigurno samo ukoliko su poklopac i kućište međusobno ispravno spojeni. Obratite posebnu pažnju da je okvir osiguran od prevrtanja prije nego uklanjate poklopac rashladne jedinice.

MT L-unità ta' tkessiĥ hija stabbli biss meta x-xaži u l-hood it-twila jkunu mqabbdin ma'xulxin. Oqghod attent/a b'mod partikolari li x-xaži ma jegħlibx qabel tneħħi l-kappa.

PL Urządzenie jest stabilne tylko wówczas, gdy pokrywa i obudowa są ze sobą połączone. Dlatego przed zdjęciem pokrywy należy zabezpieczyć obudowę przed przewróceniem się.

CZ Chladicí jednotka je stabilní jen v případě namontovaného pláště na chladicí jednotce. Před sejmutím pláště proto zajistěte samotný rám jednotky proti převrnutí.

BG Климатикът е стабилен само когато капакът и рамата са свързани помежду си. Затова укрепете най-вече рамата срещу падане, преди да свалите капака.

GR Η μονάδα ψύξης στέκεται με ασφάλεια μόνο όταν το κάλυμμα και το πλαίσιο έχουν συνδεθεί μεταξύ τους. Βεβαιωθείτε ότι ειδικά το πλαίσιο είναι ασφαλισμένο έναντι ανατροπής πριν αφαιρέσετε το κάλυμμα.

RO Aparatul de răcire este stabil numai dacă sunt interconectate capacul și carcasa. În acest scop, asigurați carcasa împotriva căderii, înainte de a scoate capacul.

HU A hűtőberendezés csak akkor áll biztonságosan, ha a burkolat és a váz egymással össze van kötve. Ezért a vázat biztosítsa eldőlés ellen, mielőtt a burkolatot leveszi.

LT Šaldymo įrenginys stabilus tol, kol gaubtas sujungtas su korpusu. Todėl prieš nuimdami gaubtą, įsitinkinkite, kad korpusas yra stabilus ir nenukristų.

EE Jahutusseade on kindlalt püsti vaid siis, kui kate ja alusraam on omavahel ühendatud. Kindlustage ümberkukkumise vastu alusraam enne katte mahavõtmist.

LV Dzesēšanas bloka droša novietošana tiek paveikta pārsegu pienācīgi savienojot ar konstrukciju. Pārļiecinieties par to, lai rāmis būtu pasargāts pret sasvēršanos, pirms pārsega noņemšanas.

SI Hladiilna naprava je stabilna, dokler sta pokrov in ohišje klime povezana. Preden snamete pokrov, je zato potrebno ohišje še posebej zavarovati, da se ne prevrne.

SK Klimatizačné zariadenie je stabilné len vtedy, ak sú kryt a spodná časť spojené. Najmä spodnú časť preto zaistite pred prevrátením ešte skôr, ako odstránite kryt.

RU Холодильный агрегат устойчив в вертикальном положении, когда кожух и основание соединены между собой. Поэтому перед удалением кожуха защитите основание агрегата от опрокидывания.



DE Vor dem Abnehmen der Haube muss das Gerät mind. 10 Min. abkühlen, um Verbrennungen an heißen Oberflächen zu vermeiden.

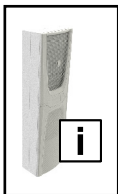

Warn- und Sicherheitshinweise / Safety instructions and warnings / Consignes de sécurité
Rittal Blue e+ enclosure cooling units

Hazards and their prevention according to IEC 60417/ISO 7000/ISO 7010

- EN** Before removing the hood, allow the unit to cool for at least 10 minutes to eliminate the risk of burns from hot surfaces.
- FR** Avant d'ôter le capot, l'appareil doit refroidir pendant au moins 10 minutes pour éviter les brûlures sur les surfaces brûlantes.
- NL** Voor het afnemen van de kap dient het apparaat minstens tien minuten af te koelen, zodat u zich niet brandt aan hete oppervlakken.
- SE** Innan huven tas av måste aggregatet svalna i minst 10 minuter för att undvika att personer bränner sig på heta ytor.
- IT** Far raffreddare il dispositivo per almeno 10 minuti prima di rimuovere la copertura per evitare eventuali ustioni al contatto con le superfici bollenti.
- ES** El equipo debe haberse enfriado durante un mínimo de 10 minutos antes de proceder a retirar la cubierta, con el fin de evitar quemaduras.
- FI** Ennen kehikon irrottamista laitteen on annettava jäähtyä vähintään 10 minuuttia, jotta vältetään kuumien pintojen aiheuttamat palovammat.
- DK** Lad enheden køle af i mindst ti minutter, før dækslet tages af, for at undgå risiko for at brænde sig på varme overflader.
- IE** Sula mbaintear an cochall de, lig don aonad fuarú ar feadh deich nóiméad ar a laghad chun an baol dó ó dhromchlaí teo a sheachaint.
- PT** Antes de remover a cobertura, deixar o aparelho arrefecer por no mínimo 10 minutos, para evitar risco de queimadura nas superfícies quentes.
- HR** Prije uklanjanja poklopca pričekajte barem 10 minuta da se uređaj ohladi, kako bi se uklonila opasnost od opekotina uzrokovanih vrućim površinama.
- MT** Qabel tneħħi l-ġhatu, l-apparat għandu jithalla jibred għal mill-inqas 10 min biex tevita ħruq minħabba uċuħ jaħarqu.
- PL** Przed zdjęciem pokrywy urządzenie musi się chłodzić przez minimum 10 minut, aby nie doszło do poparzenia przez gorące powierzchnie.
- CZ** Před sejmutím pláště jednotky je nutno nechat chladicí jednotku minimálně 10 minut vychladnout, aby nedošlo k popálení o horké povrchy.
- BG** Преди да бъде свален капакът, уредът трябва да се остави да изстине най-малко 10 минути, за да се избегнат изгаряния от горещите повърхности.
- GR** Πριν αφαιρέσετε το κάλυμμα, αφήστε τη μονάδα να ψυχθεί για τουλάχιστον 10 λεπτά για να εξαιλεφθεί ο κίνδυνος εγκαυμάτων από καυτές επιφάνειες.
- RO** Înainte de scoaterea capacului, aparatul trebuie lăsat să se răcească cel puțin 10 min., pentru a evita arsurile cauzate de contactul cu suprafețele fierbinți.
- HU** A burkolat levétele előtt a berendezést legalább 10 percig hagyja lehűlni a forró felületek miatti égési sérülések elkerülése érdekében.
- LT** Prieš nuimdami gaubtą, turite palaukti bent 10 minučių, kol įrenginys atvės, kad nenusidegintumėte prisilietę prie karštų paviršių.
- EE** Enne kätte mahavõtmist peab seade vähemalt 10 minutit jahtuma, et vältida põletusi kuumade pindade tõttu.
- LV** Pirms pārsega atvēršanas, ļaujiet iekārtai atdzist vismaz 10 minūtes, lai izvairītos no apdedzināšanās riska, ko rada uzkaršušās virsmas.
- SI** Preden snamete pokrov, naj se naprava najmanj 10 minut ohlaja, da se izognete nevarnosti opeklin na vročih površinah.
- SK** Pred odstránením krytu musí zariadenie minimálne 10 minút chladnúť, inak môže dôjsť k popáleniu na horúcich povrchoch.
- RU** Перед снятием кожуха дать агрегату остыть в течение ок. 10 мин., во избежание ожога о горячие поверхности.



- DE** Verwenden Sie niemals brennbare Flüssigkeiten zur Reinigung des Geräts.
- EN** Never use flammable liquids for cleaning.
- FR** Ne jamais utiliser de liquides inflammables pour le nettoyage.
- NL** Gebruik geen brandbare vloeistoffen voor het reinigen.
- SE** Använd inga brännbara vätskor för rengöring.
- IT** Non utilizzare liquidi infiammabili per la pulizia.
- ES** No utilice líquidos inflamables para realizar la limpieza.
- FI** Älä käyttää puhdistukseen palavia nesteitä.
- DK** Brug aldrig brændbare væsker til rengøring.
- IE** Ná húsáid leachtanna inlasta riamh i gcomhair glanta.
- PT** Nunca utilizar líquidos inflamáveis para efetuar a limpeza.
- HR** Nikada ne koristite zapaljive tekućine za čišćenje.
- MT** Tużax likwidi li jieħdu n-nar għat-tindif.
- PL** Do czyszczenia urządzenia nie stosować łatwopalnych cieczy.
- CZ** Nepoužívejte k čištění žádné hořlavé kapaliny.
- BG** Не използвайте запалими течности за почистване.
- GR** Μη χρησιμοποιείτε ποτέ εύφλεκτα υγρά για τον καθαρισμό.
- RO** Nu utilizați lichide inflamabile pentru curățare.
- HU** Tisztításhoz ne használjon gyúlékony folyadékot.

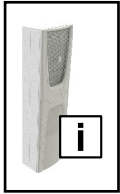

Warn- und Sicherheitshinweise / Safety instructions and warnings / Consignes de sécurité
Rittal Blue e+ enclosure cooling units

Hazards and their prevention according to IEC 60417/ISO 7000/ISO 7010

- LT** Valydami nenaudokite degių skysčių.
EE Ärge kasutage puhastamiseks põlevaid vedelikke.
LV Nekad neizmantojiet uzliesmojošus tīršanas līdzekļus.
SI Za čiščenje ne uporabljajte vnetljivih tekočin.
SK Na čistenie nepoužívajte horľavé kvapaliny.
RU Никогда не используйте горючие жидкости для чистки агрегата.

DE Das Kühlgerät ist ausschließlich zum Kühlen von geschlossenen Schaltschränken sowie zur professionellen Nutzung gemäß DIN EN 61000-3-2 vorgesehen. Eine andere Verwendung ist nicht bestimmungsgemäß.

- Das Gerät darf nicht an Orten installiert und betrieben werden, die der allgemeinen Öffentlichkeit (siehe DIN EN 60335-2-40, Absatz 3.119) zugänglich sind.
- Das Gerät ist nur für den stationären Betrieb ausgelegt.

FR Le climatiseur est prévu uniquement pour rafraîchir les armoires électriques fermées ainsi que pour une utilisation professionnelle conformément à la norme DIN EN 61000-3-2. Toute autre utilisation est non conforme.

- Le climatiseur ne doit pas être installé et exploité dans des lieux accessibles au public (voir norme EN 60335-2-40, paragraphe 3.119).
- Le climatiseur est uniquement destiné à l'exploitation statique.

SE Kylaggregatet är endast avsedd för kylning av slutna apparatskåp i enlighet med DIN EN 61000-3-2. Annan användning är inte tillåten.

- Aggregatet får inte installeras och köras på platser som är tillgängliga för allmänheten (se DIN EN 60335-2-40, stycke 3.119).
- Aggregatet är konstruerat uteslutande för stationär drift.

ES El refrigerador se ha diseñado exclusivamente para la refrigeración de armarios de distribución estancos, para su uso según lo detallado en la normativa DIN EN 61000-3-2. Cualquier otro uso no está permitido.

- El equipo no debe ser instalado ni puesto en funcionamiento en entornos accesibles al público en general (ver DIN EN 60335-2-40, párrafo 3.119).
- El equipo está diseñado para un funcionamiento estacionario.

DK Køleenheden er kun beregnet til køling af lukkede indkapslinger og kun til professionelt brug i henhold til DIN EN 61000-3-2. Enhver anden brug er ikke tilladt.

- Enheden må ikke installeres eller opereres på lokaliteter med offentlig adgang (Se DIN EN 60335-2-40, paragraf 3.119)
- Enheden er udelukkende designet til stationært brug.

EN The cooling unit is intended exclusively for cooling closed control cabinets as well as for professional use in accordance with DIN EN 61000-3-2. Any other use is not permitted.

- The unit must not be installed and operated in locations which are accessible to the general public (see DIN EN 60335-2-40, paragraph 3.119).
- The unit is designed solely for stationary use.

NL Het koelaggregaat is uitsluitend bestemd voor het koelen van gesloten schakelkasten en voor professioneel gebruik volgens DIN EN 61000-3-2. Elke andere toepassing wordt gezien als niet-voorgescreven gebruik.

- Het apparaat mag niet worden geïnstalleerd op plaatsen die openbaar (zie DIN EN 60335-2-40, paragraaf 3.119) toegankelijk zijn.
- Het apparaat is alleen ontworpen voor stationair gebruik.

IT Il condizionatore è destinato esclusivamente al raffreddamento degli armadi di comando chiusi e per uso professionale secondo EN 61000-3-2. Ogni altro impiego è da intendersi non conforme alla sua destinazione d'uso.

- L'apparecchio non deve essere installato e utilizzato in aree accessibili al pubblico (vedere la norma DIN EN 60335-2-40, paragrafo 3.119).
- L'apparecchio può essere utilizzato solo da fermo.

FI Jäähdytysyksikkö on tarkoitettu yksinomaan suljettujen koteloiden jäähdytykseen sekä ammattikäyttöön DIN EN 61000-3-2 mukaisesti. Mikään muu käyttö ei ole sallittua.

- Laitetta ei saa asentaa ja käyttää yleisessä käytössä olevissa paikoissa (katso DIN EN 60335-2-40, kohta 3.119).
- Laite on suunniteltu ainoastaan kiinteään käyttöön.

IE Nil an t-aonad fuairithe ceaptha ach amháin d'fhuarú na gcaibinéad rialaithe dúnta agus d'úsáid ghairmiúil eile i gcomhréir le DIN EN 61000-3-2. Ní cheadaítear d'aon úsáid eile.

- Ná suiteáiltear agus ná oibrítear an t-aonad i suíomhanna arb inrochtana don phobal i gcoitinne iad (féach DIN EN 60335-2-40, mír 3.119).
- Is le húsáid dho-aistrithe amháin a dearadh an t-aonad.

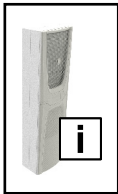

Warn- und Sicherheitshinweise / Safety instructions and warnings / Consignes de sécurité
Rittal Blue e+ enclosure cooling units

Hazards and their prevention according to IEC 60417/ISO 7000/ISO 7010

- PT** A unidade de refrigeração destina-se exclusivamente à refrigerar gabinetes de controle fechados, bem como para uso profissional de acordo com a DIN EN 61000-3-2. Qualquer outro uso não é apropriado e não é permitido.
- O aparelho não deve ser instalado e operado em locais acessíveis ao público em geral (consulte a norma DIN EN 60335-2-40, seção 3.119).
 - O aparelho foi projetado apenas para o uso em instalação fixa.
- MT** It-tagħmir refriġeranti għandu jintuża esklussivament biex ikessah l-armarji magħluqin kif ukoll għall-użu professjonali skont DIN EN 61000-3-2. Użu ieħor ta' dan huwa ħażin.
- L-apparat ma għandux jiġi installat u ma għandux jithaddem f'postijiet li huma aċċessibbli għall-pubbliku (ara DIN EN 60335-2-40, Paragrafu 3.119)
 - L-apparat huwa ddisinjat biss għal tħaddim stazzjonarju.
- CZ** Chladicí jednotka je určena výhradně k chlazení uzavřených rozváděčových skříní a k profesionálnímu použití v souladu s ČSN EN 61000-3-2. Jiné použití není použito v souladu s určením.
- Zařízení se nesmí instalovat a provozovat na místech, která jsou veřejně přístupná (viz DIN EN 60335-2-40, oddíl 3.119).
 - Zařízení je navrženo jen pro stacionární provoz.
- GR** Η μονάδα ψύξης προορίζεται αποκλειστικά για ψύξη κλειστούς πίνακες ελέγχου καθώς και για επαγγελματική χρήση σύμφωνα με το DIN EN 61000-3-2. Οποιαδήποτε άλλη χρήση δεν επιτρέπεται.
- Δεν επιτρέπεται η εγκατάσταση και η λειτουργία της συσκευής σε σημεία, τα οποία είναι προσβάσιμα στο ευρύ κοινό (δείτε DIN EN 60335-2-40, σημείο 3.119).
 - Η συσκευή έχει σχεδιαστεί αποκλειστικά για στατική χρήση.
- HU** A hűtőberendezés kizárólag zárt kapcsoló- és vezérlőszekrények hűtésére, valamint a DIN EN 61000-3-2 szabvánnyal összhangban történő professzionális alkalmazásra használható. Minden más alkalmazás tilos.
- A berendezést tilos olyan helyre telepíteni és üzemeltetni, amely szabadon hozzáférhető laikusok számára (lásd DIN EN 60335-2-40, 3.119 bekezdés).
 - A berendezést kizárólag fixen telepítve és álló helyzetben szabad telepíteni és üzemeltetni.
- EE** Jahutusseadmed on ettenähtud ainult kinniste kilpide jahutamiseks ja professionaalseks kasutamiseks vastavalt standardile DIN EN 61000-3-2. Muu laadne kasutus ei ole lubatud.
- Seadmete kasutus üldkasutatavates ruumides ei ole lubatud (vaata DIN EN 60335-2.40, § 3.119).
 - Seade on ettenähtud ainult statsionaarseks paigalduseks.
- HR** Klima uređaj namijenjen je isključivo hladenu nanizanih ormara te profesionalnoj uporabi sukladno DIN EN 61000-3-2. Drugačija uporaba nije dozvoljena.
- Uređaj se ne smije instalirati i raditi na mjestima gdje je dostupan javnosti (DIN EN 60335-2-40, paragraph 3.119)
 - Uređaj je namijenjen isključivo za unutarnju upotrebu.
- PL** To urządzenie chłodnicze jest przewidziane wyłącznie do chłodzenia zamkniętych szaf sterowniczych oraz do użytku profesjonalnego zgodnie z normą DIN EN 61000-3-2. Każde inne zastosowanie jest niezgodne z przeznaczeniem.
- Urządzenie nie może być instalowane i użytkowane w miejscach ogólnodostępnych (patrz EN 60335-2-40, punkt 3.119).
 - Urządzenie jest przystosowane wyłącznie do użytkowania stacjonarnego.
- BG** Охладителното устройство е предназначено само за охлаждане на кутии и шкафове както и за професионална употреба съгласно DIN EN 61000-3-2. Не се разрешава всякаква друга употреба.
- Уредът не трябва да се монтира и работи в местата, които са достъпни за широката общественост (виж DIN EN 60335-2-40, параграф 3.119).
 - Уредът е предназначен единствено за стационарна употреба.
- RO** Climatizorul este conceput doar pentru racirea dulapurilor inchise precum si pentru o utilizare industriala conform normelor DIN EN 61000-3-2. Orice alta utilizare nu este permisa.
- Unitatea nu trebuie instalata si folosita in locatii la care are acces publicul larg. (vezi DIN EN 60335-2-40, paragraf 3.119)
 - Unitatea este proiectata doar pentru utilizare stationara.
- LT** Vėsinimo agregatas skirtas tik uždaro tipo skydų vėsinimui, taip pat profesionaliam naudojimui pagal DIN EN 61000-3-2. Bet koks kitas naudojimas yra draudžiamas.
- Agregatas negali būti sumontuojamas ir eksploatuojamas viešai prieinamose vietose (pagal DIN EN 60335-2-40, punktą 3.119)
 - Prietaisas skirtas tik stacionariam naudojimui.
- LV** Dzesēšanas bloks paredzēts tikai sadalīnu ar slēgto kontroli dzesēšanai, kā arī profesionālai lietošanai saskaņā ar DIN EN 61000-3-2. Jebkura cita izmantošana nav atļauta.
- Iekārtu nedrīkst uzstādīt un izmantot publiski pieejamās vietās (skatīt standarta DIN EN 60335-2-40, paragrāfu 3.119).
 - Iekārta ir izstrādāta tikai stacionārai lietošanai.

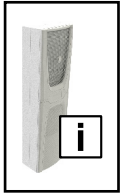

Warn- und Sicherheitshinweise / Safety instructions and warnings / Consignes de sécurité
Rittal Blue e+ enclosure cooling units

Hazards and their prevention according to IEC 60417/ISO 7000/ISO 7010

SI

Hladilna naprava je namenjena samo za hlajenje vrstno povezanih ohišij, kot tudi za profesionalno uporabo skladno z DIN EN 61000-3-2. Vsaka druga uporaba ni dovoljena.

- Naprava ne sme biti nameščena in delovati na lokaciji ki je dostopna širši javnosti (glej DIN EN 60335-2-40, odstavek 3.119).
- Naprava je namenjena izključno za stacionarno uporabo.

RU

Агрегат предназначен исключительно для охлаждения закрытых распределительных шкафов, а также для профессионального использования согл. DIN EN 61000-3-2. Использование в других целях не соответствует его прямому назначению.

- Агрегат нельзя устанавливать и эксплуатировать в местах, доступных для посторонних лиц (см. DIN EN 60335-2-40, абзац 3.119)
- Агрегат предназначен для только для стационарного применения.

SK

Chladiaca jednotka je určená pre chladenie uzavretých rozvádzačových skríň ako aj iných zariadení, ktoré sú v súlade s normou DIN EN 61000-3-2. Iné použitie nie je prípustné.

- Zariadenie nesmie byť inštalované a používané vo verejne dostupných priestoroch (viď DIN EN 60335-2-40, odstavec 3.119).
- Zariadenie je určené na stacionárnu prevádzku.

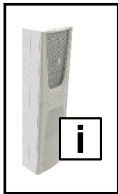

Inhalt / Contents / Sommaire

		<p>Sicherheitshinweise Safety instructions Consignes de sécurité3</p> <p>Zubehör Accessories Accessoires 11</p> <p>Befestigungs- und Installationsmaterial Mounting and installation materials Matériel de fixation et d'installation 12</p> <p>Technische Daten Technical specifications Caractéristiques techniques 13</p> <p>Montagemöglichkeiten Mounting options Options de montage 15</p> <p>Kühlgerät als Anbau montieren External mounting of the cooling unit Montage en saillie du climatiseur 17</p> <p>Kühlgerät als Teileinbau montieren Partial internal mounting of the cooling unit Intégration partielle du climatiseur 23</p> <p>Kühlgerät als Volleinbau montieren Full internal mounting of the cooling unit Intégration complète du climatiseur 27</p> <p>Kondensatwasserablauf anschließen Connecting the condensate water discharge Raccordement du tuyau d'évacuation des eaux de condensation 32</p> <p>Hinweise zur Elektroinstallation Notes on electrical installation Instructions relatives à l'installation électrique 32</p> <p>Elektrischer Anschluss Electrical connection Raccordement électrique 33</p> <p>Montageausbrüche Mounting cut-outs Découpes de montage 37</p> <p>Abmessungen Dimensions Dimensions 39</p> <p>Konformitätserklärung Declaration of conformance Déclaration de conformité 42</p>
2...10, 13...15, 42	11...12	
32...36	15...32	
37...41		



In dieser Anleitung werden nur an den Stellen Bilder des Geräts SK 3185x30 gezeigt, an denen die Montage von der gezeigten Darstellung abweicht.

Pictures of the SK 3185x30 device are shown only in the places where the assembly deviates from the illustration shown in this manual.

Dans ces instructions, des images de l'appareil SK 3185x30 sont uniquement affichées aux endroits où le montage diffère de la représentation montrée.

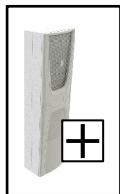

Zubehör / Accessories / Accessoires

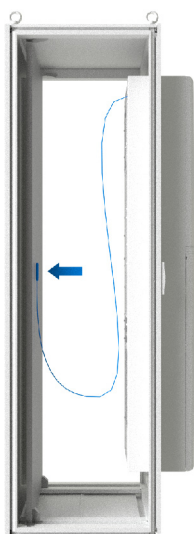

Externer Temperaturfühler
External temperatur sensor
Sonde de température
externe

DE



EN



FR



Best.-Nr. / Model No. / Référence 3124400



Filtermatten
Filter mats
Cartouches filtrantes

DE



EN



FR



Best.-Nr. / Model No. / Référence 3285900, 3285910,
3285800, 3285810



Kondensatschlauch
Condensate hose
Tuyau d'écoulement des
condensats

DE



EN



FR



Best.-Nr. / Model No. / Référence 3301612



Türenschanter
Door-operated switch
Contact de porte

DE



EN



FR



Best.-Nr. / Model No. / Référence 4127010



IoT Interface

DE



EN









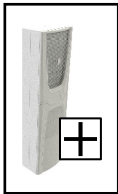



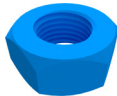

FR



Best.-Nr. / Model No. / Référence 3124300



Befestigungs- und Installationsmaterial / Mounting and installation materials / Matériel de fixation et d'installation

6 x	M8 x 40			1 x	
6 x	M8			1 x	
6 x	M8			1 x	
1 x	10 x 10 mm, L = 2,7 m	SK 3185x30		1 x	
1 x	10 x 10 mm, L = 4,1 m	SK 3186x30 SK 3187x30 SK 3188x40 SK 3189x40		1 x	
4 x		SK 3185x30		2 x	
6 x		SK 3186x30 SK 3187x30 SK 3188x40 SK 3189x40		2 x	SK 3185x30 SK 3186x30 SK 3187x30 
4 x					

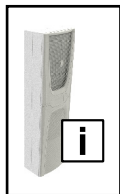

Technische Daten / Technical specifications / Caractéristiques techniques

Technische Daten Technical specifications Caractéristiques techniques	SK 3185830 SK 3185530	SK 3186930 SK 3186630	SK 3187930 SK 3187630	SK 3188940 SK 3188640	SK 3189940 SK 3189640
Allgemeine Daten/General specifications/Caractéristiques générales					
Bestellnummer Stahlblech Model number sheet steel Référence – tôle d'acier	SK 3185830	SK 3186930	SK 3187930	SK 3188940	SK 3189940
Bestellnummer Edelstahl, 1.4301 Model number stainless steel, 1.4301 Référence – acier inoxydable AISI 304 (1.4301)	SK 3185530	SK 3186630	SK 3187630	SK 3188640	SK 3189640
Abmessungen (Breite x Höhe x Tiefe) [mm] Dimensions (width x height x depth) [mm] Dimensions (largeur x hauteur x profondeur) [mm]	400 x 950 x 310	450 x 1600 x 294		450 x 1600 x 393	
Kühlleistung nach DIN EN 14511 [kW]/Cooling output to EN 14511 [kW]/Puissances frigorifiques selon DIN EN 14511 [kW]					
Gesamtkühlleistung Pc L35 L35 Total cooling output Pc L35 L35 Puissance frigorifique totale Pc L35 L35	1,60	2,00	2,60	4,20	5,80
Gesamtkühlleistung Pc L35 L50 Total cooling output Pc L35 L50 Puissance frigorifique totale Pc L35 L50	1,20	1,29	1,82	3,02	4,20
Sensible Kühlleistung Ps L35 L35 Sensible cooling capacity Ps L35 L35 Puissance frigorifique sensible Ps L35 L35	1,60	2,00	2,60	4,20	5,30
Leistungsaufnahme Pel L35 L35 Power consumption Pel L35 L35 Puissance absorbée Pel L35 L35	0,54	0,57	0,99	1,21	2,20
Leistungsaufnahme Pel L35 L50 Power consumption Pel L35 L50 Puissance absorbée Pel L35 L50	0,61	0,60	0,94	1,28	2,20
Energy efficiency ratio (EER) L35 L35 Coefficient d'efficacité énergétique (EER) L35 L35	3,10	3,5	2,63	3,46	2,64
Elektrische Daten/Electrical specifications/Caractéristiques électriques					
Bemessungsspannung [V, ~, Hz], Toleranz Rated voltage [V, ~, Hz], tolerance Tension nominale [V, ~, Hz], tolérance	110...240, 1, 50/60, +10%/-10%			-	
	380...480, 3, 50/60, +5%/-15%				
Bemessungsisolationsspannung Ui [V] Rated insulation voltage Ui [V] Tension d'isolation nominale Ui [V]	500				
Bemessungsleistung [kW]/Rated output [kW]/Puissance nominale [kW]	0,62	0,73	1,05	1,30	2,20
Rating of over current protective device [A] Dispositif de protection contre les surintensités [A]	15				
Minimum circuit ampacity [A]/ Intensité minimale du circuit [A]	15				
Input ampere range [A] Plage d'entrée d'intensité [A]	6,2@110 V – 1,1@380 V	7,3@110 V – 1,3@380 V	11@110 V – 1,8@380 V	2,3@380 V – 1,8@480 V	3,7@380 V – 2,9@480 V
Vorsicherung T [A]/Pre-fuse T [A]/Dispositif de sécurité T [A]	16 (EN 61439) 15 (UL 508A)				
Typ der Vorsicherung / Pre-fuse type / Type de dispositif de sécurité	Time delay fuse type CCMR/fusibles retardés CCMR				
Alternativ einer der folgenden UL gelisteten Schutzschalter (DIVQ/7) / Alternatively, one of the following UL listed circuit-breakers (DIVQ/7) / Alternativement un des disjoncteurs suivants certifié UL (DIVQ/7)	<ul style="list-style-type: none"> - 3RV2711-4AD10 by SIEMENS (E235044) rated 15 A (SCCR = 65 kA) - FAZ-C15/3-NA by EATON (E235139) Class curve C rated 15 A (SCCR = 14 kA) - FAZ-D15/3-NA by EATON Class curve D rated 15 A (SCCR = 14 kA) 				

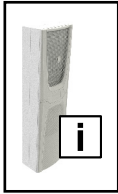

Technische Daten / Technical specifications / Caractéristiques techniques

Technische Daten Technical specifications Caractéristiques techniques	SK 3185830 SK 3185530	SK 3186930 SK 3186630	SK 3187930 SK 3187630	SK 3188940 SK 3188640	SK 3189940 SK 3189640
SCCR [kA]	5				
Leitungsquerschnitt [mm ²]/Cable cross-section [mm ²]/ Section de câble [mm ²]	1,5 (EN 61439) ≥2,1 oder/or/ou ≤14 AWG) (UL 508A)				
Überspannungskategorie/Overvoltage category/Catégorie de surtension	III				
Verschmutzungsgrad/Level of contamination/Taux d'en- crassement	III				
Schutzart/Protection category/Indice de protection					
IP Rating/Indice de protection IP	24				
Schutzart des Schaltschranks bei angebautem Gerät/Protection category with the unit externally mounted/ Indice de protection de l'armoire électrique avec appareil installé					
IP Rating/Indice de protection IP	55				
UL Typerring/Indice de protection NEMA	12, 3R				
Elektromagnetische Verträglichkeit/Electromagnetic compatibility/Compatibilité électromagnétique					
Störfestigkeit/Immunity to interference/Résistance au brouillage	Für Industriebereiche gemäß EN 61000-6-2 For industrial areas to EN 61000-6-2 Pour environnement industriel selon la norme EN 61000-6-2				
Störaussendung/Emitted interference/Émission de pertur- bations	Für Wohn-, Geschäfts- und Gewerbebereiche sowie Kleinbetriebe gemäß EN 61000-6-3 For residential, business and commercial areas and small companies to EN 61000-6-3 Pour les zones d'habitation, d'activité et industrielles ainsi que pour les petites entreprises selon la norme EN 61000-6-3				
Kältemittelkreislauf/Refrigerant circuit/Circuit frigorifique					
Zulässiger Druck (PS) HD/ND [MPa] Admissible pressure (PS) HP/LP [MPa] Pression admissible (PS) HP/BP [MPa]	2,4				
Betriebstemperaturbereich [°C] Operating temperature range [°C] Plage de température de fonctionnement [°C]	-20...+60				
Aktivbetrieb Heat Pipe [°C] Heat pipe active mode [°C] Plage de température de fonctionnement du caloduc [°C]	0...+60				
Aktivbetrieb Kältemittelkreislauf [°C] Refrigerant cycle active mode [°C] Plage de température de fonctionnement du circuit frigorif- rique [°C]	+10...+60				
Einstellbereich Sollwert [°C] Setting range set value [°C] Plage de réglage de la température de consigne [°C]	+20...+50				
Kältemittelidentifikation Refrigerant identification Type de fluide frigorigène	R134a, Tetrafluorethan (CH ₂ FCF ₃)				
Kältemittelfüllmasse Kompressionssystem/Heat Pipe-Sys- tem [g]/Refrigerant filling mass compression system/heat pipe system [g]/Poids fluide frigorigène circuit frigorifique avec compresseur + caloduc [g]	300/450	500/650	700/1050		
GWP	1430				
CO ₂ e [t]	1,07	1,64	1,64	2,50	2,50
Sonstiges/Other/Divers					
Gewicht [kg]/Weight [kg]/Poids [kg]	30,5	55,2	72,4		

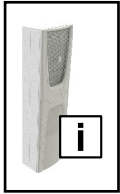

Technische Daten / Technical specifications / Caractéristiques techniques

Technische Daten Technical specifications Caractéristiques techniques	SK 3185830 SK 3185530	SK 3186930 SK 3186630	SK 3187930 SK 3187630	SK 3188940 SK 3188640	SK 3189940 SK 3189640
Lagertemperaturbereich [°C]/Storage temperature range [°C]/Plage de température de stockage [°C]	-40...+70				
Schalldruckpegel Lp [dB(A)]/Noise pressure level Lp [dB(A)]/Niveau sonore Lp [dB(A)]	<67		<70		<71
Weiterführende Informationen Further information Informations complémentaires					
Approbationen Approvals Homologations	 <small>TUV NORD System GmbH & Co. KG Performance tested according to EN 14561 Enclosure cooling unit Rittal Blue e+ series Periodic product testing SEPP-2006/15</small>		 <small>UL US LISTED</small>	 <small>TUV NORD GS Product Group Enclosures</small>	

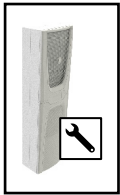

Montagemöglichkeiten / Mounting options / Options de montage

SK 3185x30

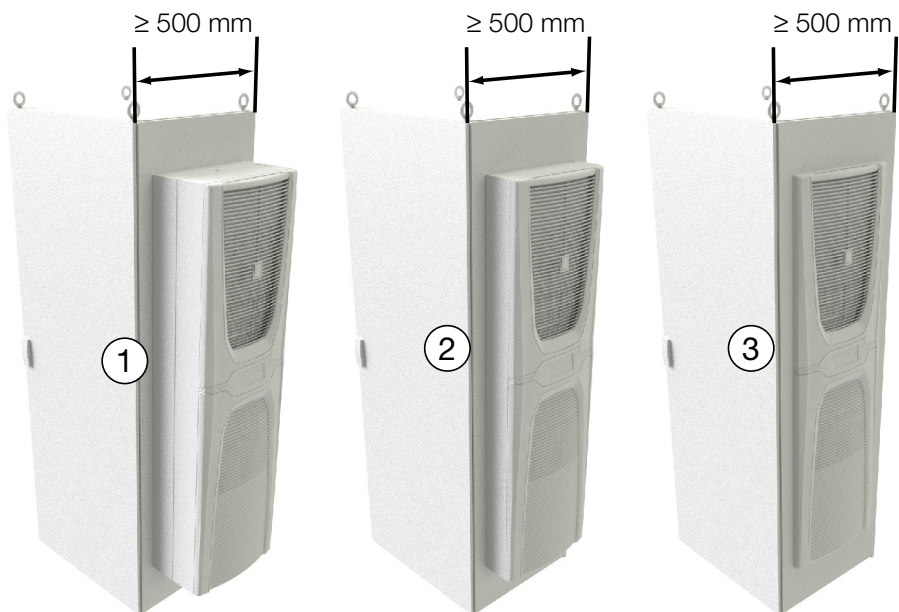
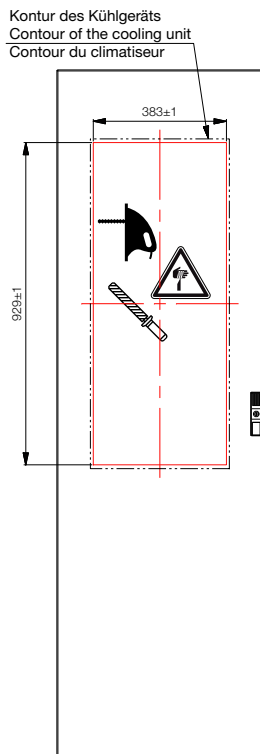

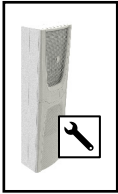

Montagemöglichkeiten / Mounting options / Options de montage

SK 3186x30/SK 3187x30/SK 3188x40/SK 3189x40

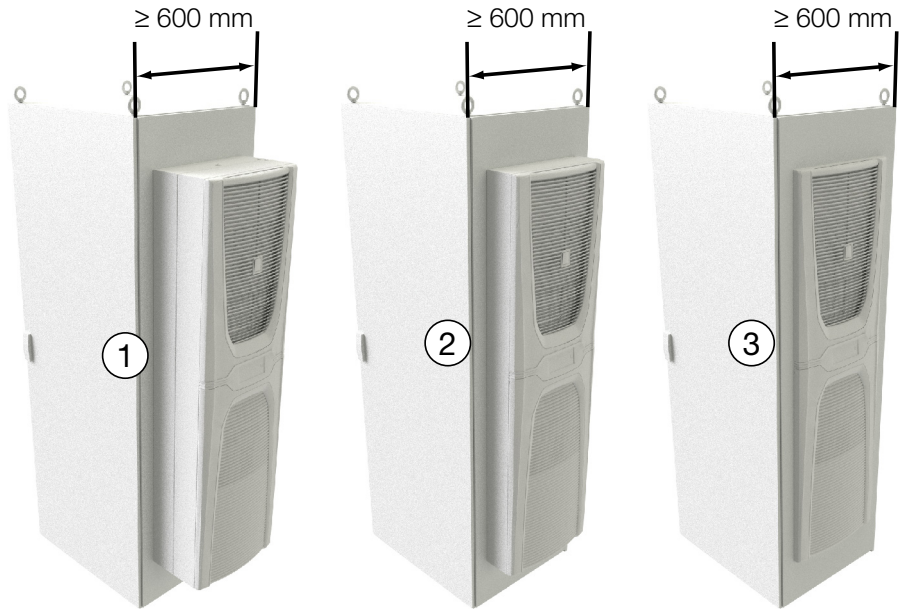
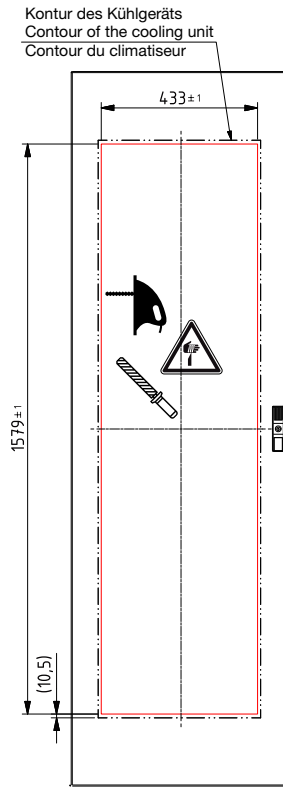

SK 3188x40
SK 3189x40

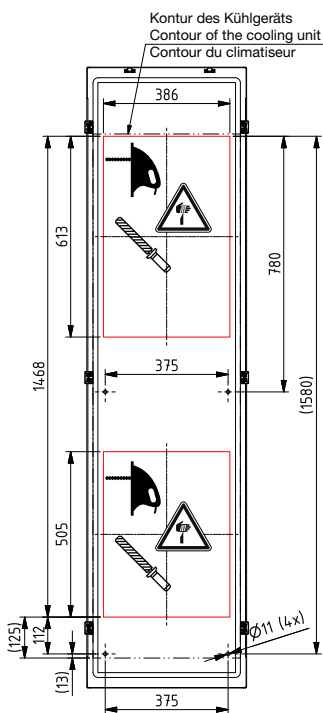

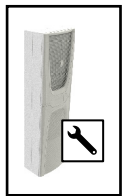

Kühlgerät als Anbau montieren / External mounting of the cooling unit / Montage en saillie du climatiseur

≥ 500 mm

SK 3185x30

≥ 600 mm







SK 3186x30

SK 3187x30

SK 3188x40

SK 3189x40

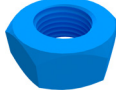

1 x		4 x		2 x		4 x	
4 x		4 x		4 x	SK 3185x30		
				6 x	SK 3186x30		
					SK 3187x30		
					SK 3188x40		
					SK 3189x40		

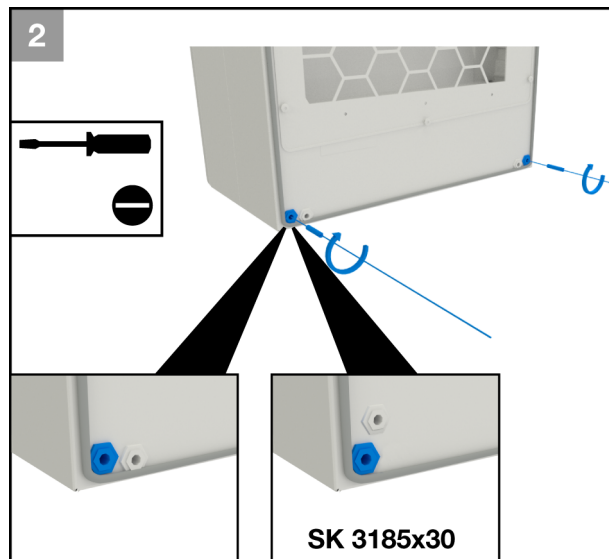
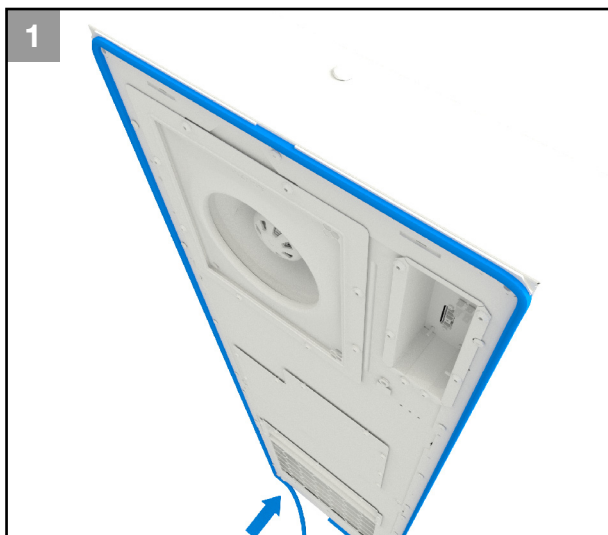

SK 3185x30

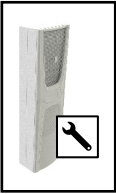

Kühlgerät als Anbau montieren / External mounting of the cooling unit / Montage en saillie du climatiseur

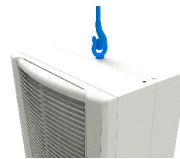
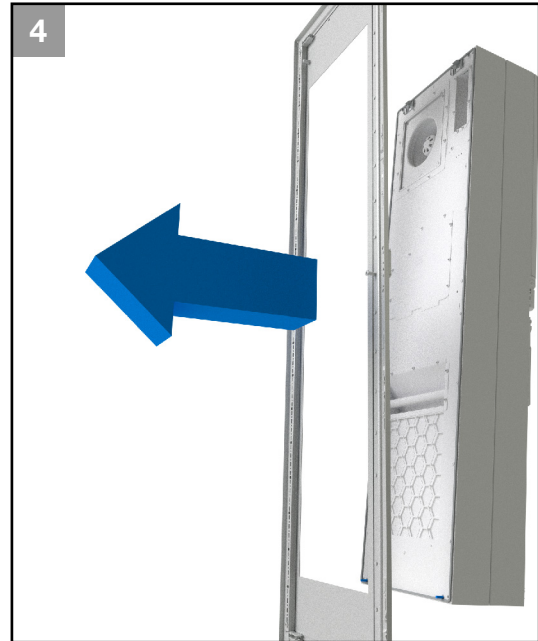
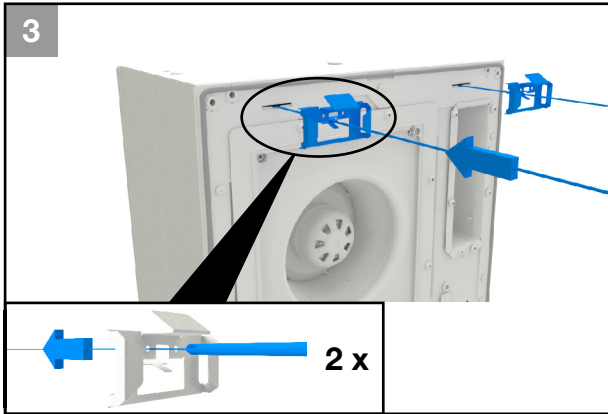

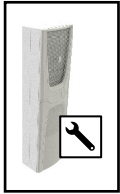

Kühlgerät als Anbau montieren / External mounting of the cooling unit / Montage en saillie du climatiseur

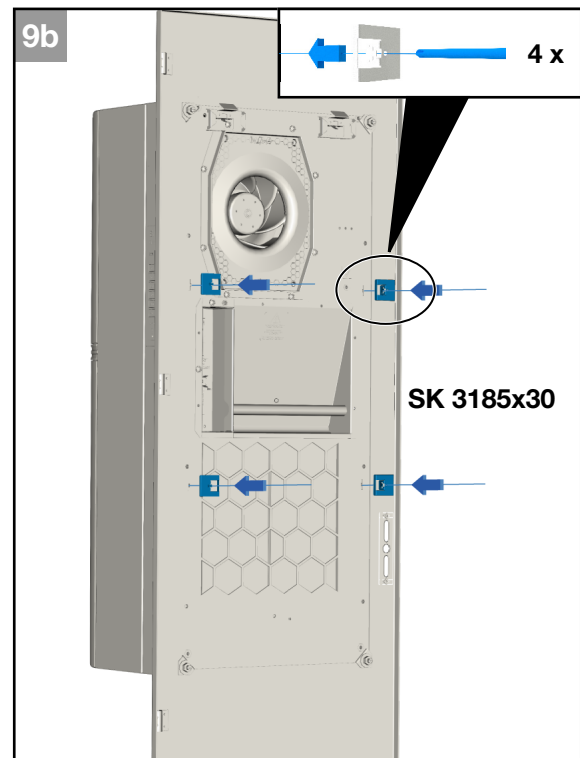
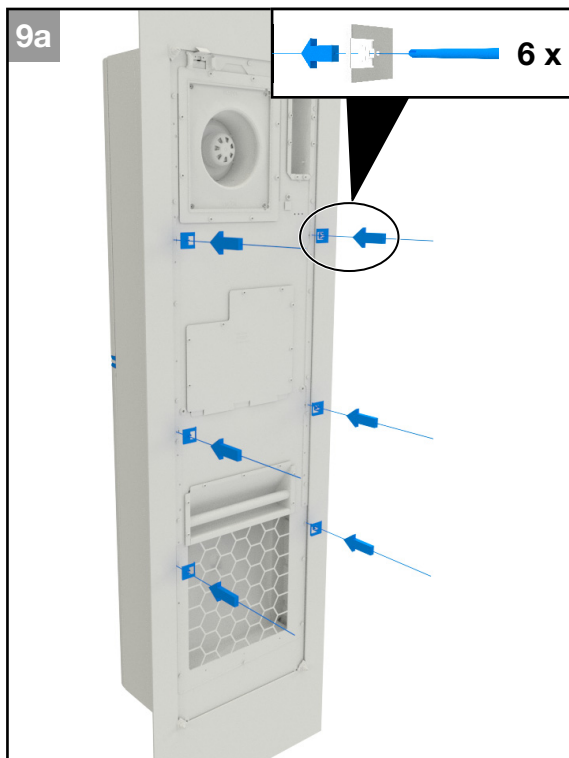
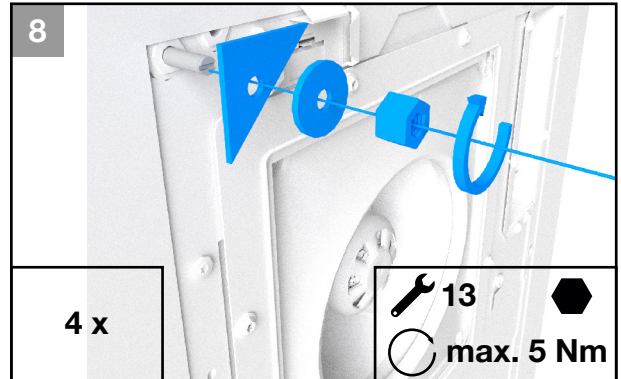
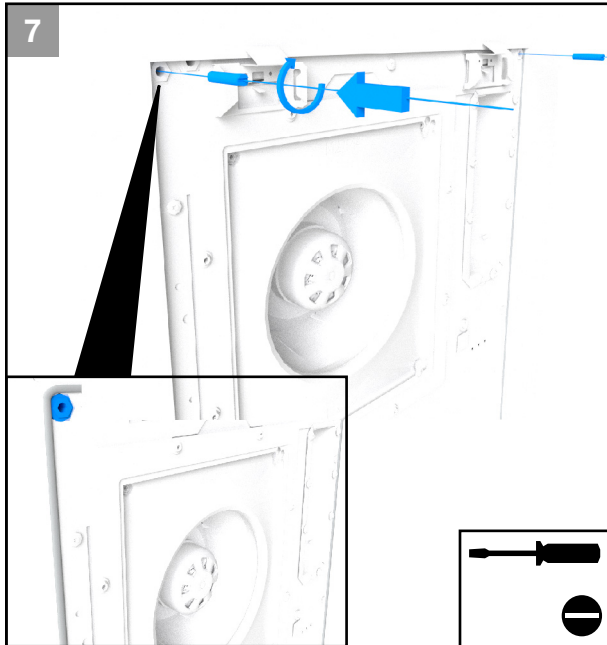

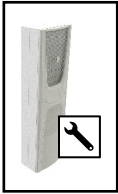

Kühlgerät als Anbau montieren / External mounting of the cooling unit / Montage en saillie du climatiseur



SK 3186x30
SK 3187x30
SK 3188x40
SK 3189x40

1 x		6 x		2 x		2 x	
6 x		6 x					

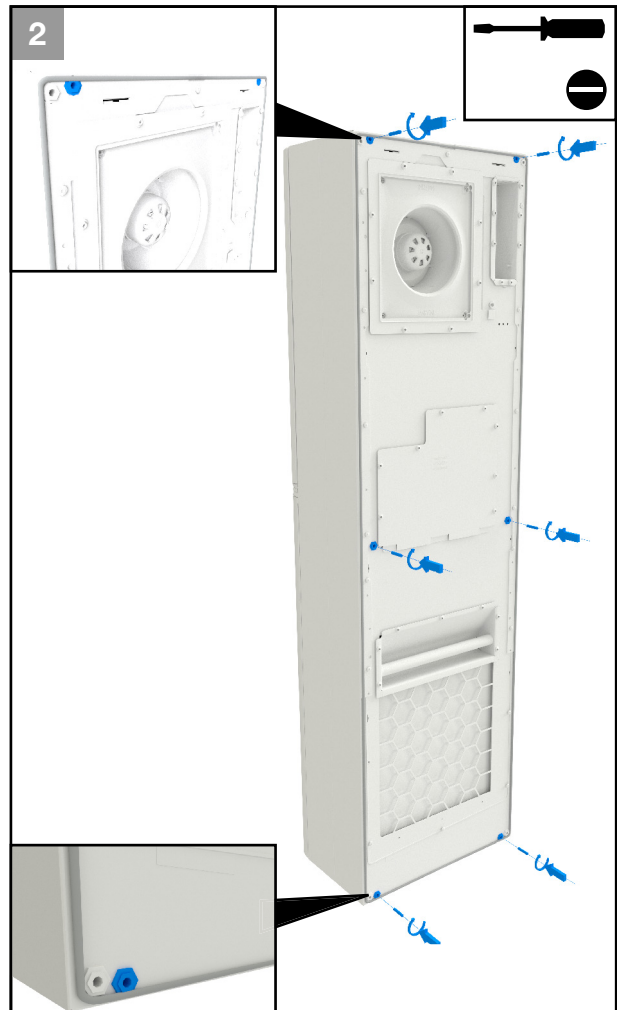
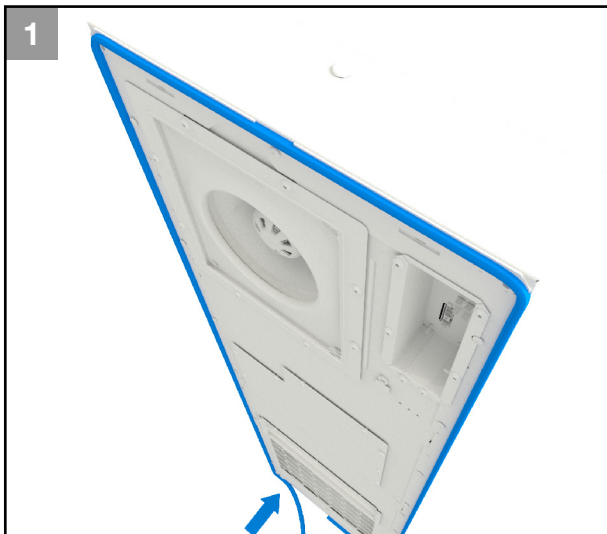



Kühlgerät als Anbau montieren / External mounting of the cooling unit / Montage en saillie du climatiseur

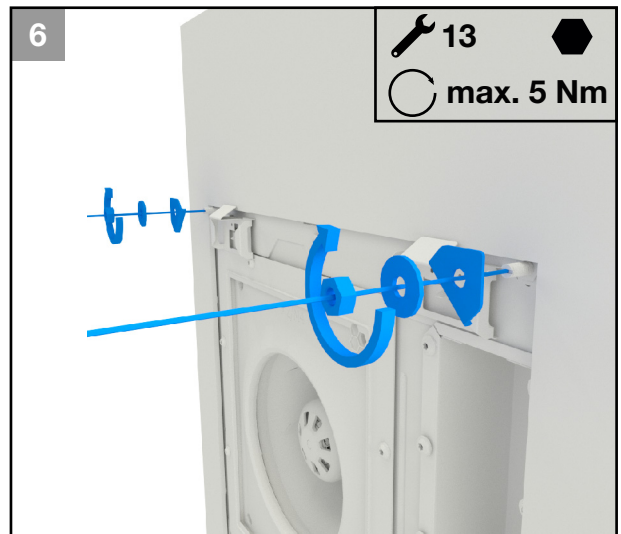
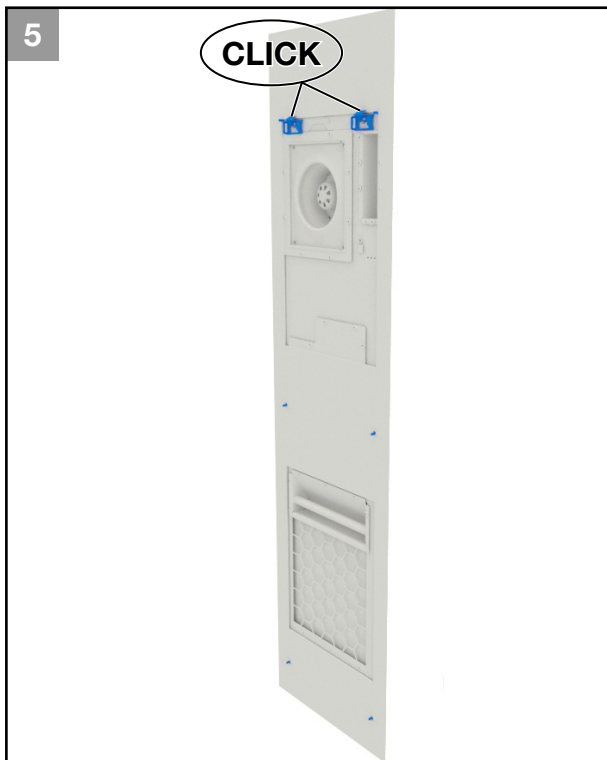
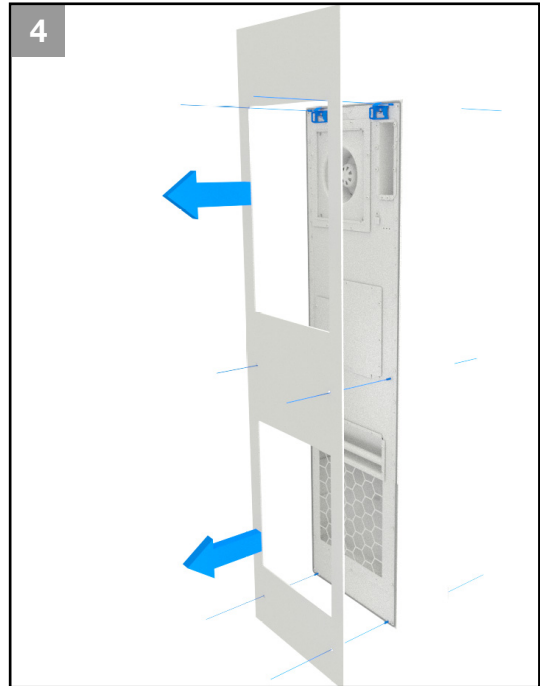
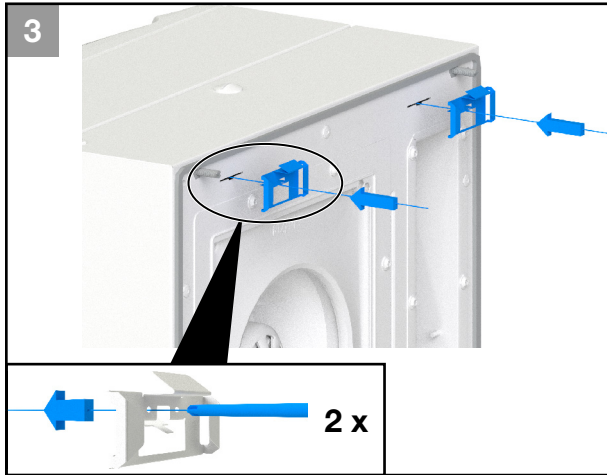

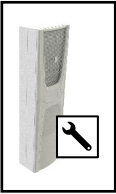

Kühlgerät als Anbau montieren / External mounting of the cooling unit / Montage en saillie du climatiseur

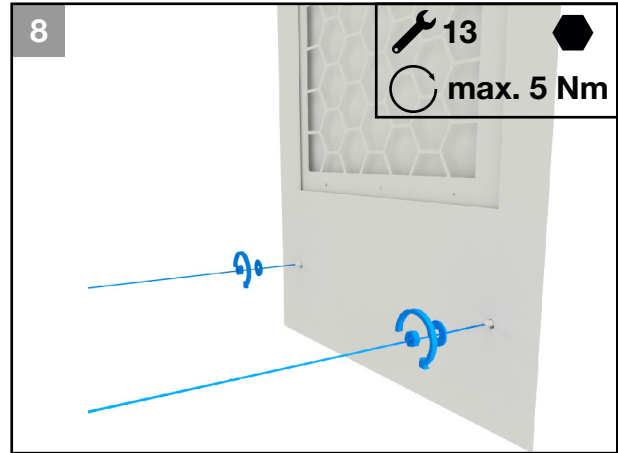
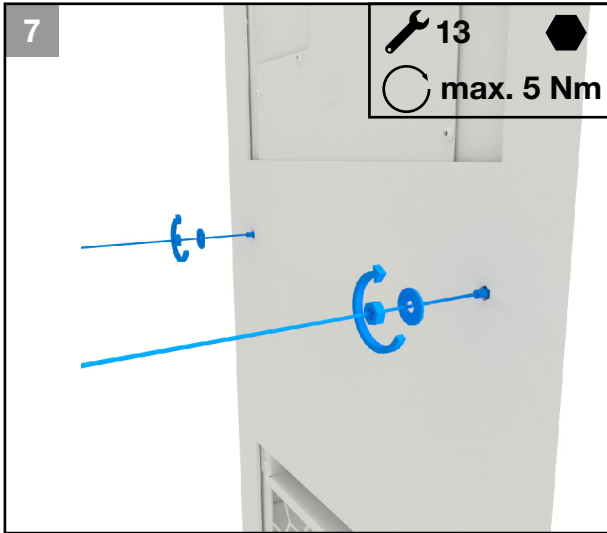

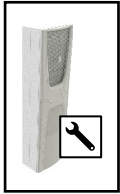

Kühlgerät als Teilbau montieren / Partial internal mounting of the cooling unit / Intégration partielle du climatiseur

≥ 500 mm

SK 3185x30

≥ 600 mm

SK 3186x30

SK 3187x30

SK 3188x40

SK 3189x40



1 x

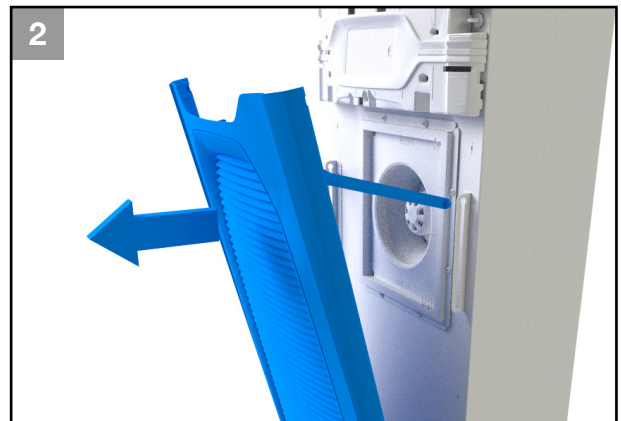
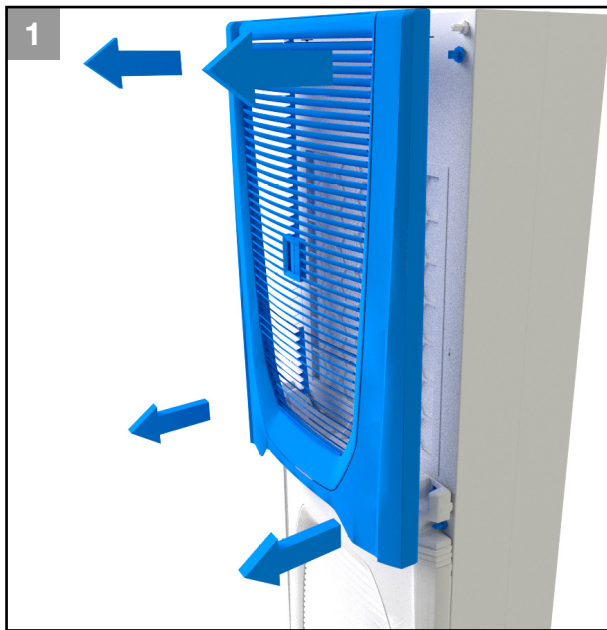

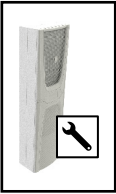

Kühlgerät als Teilbau montieren / Partial internal mounting of the cooling unit / Intégration partielle du climatiseur

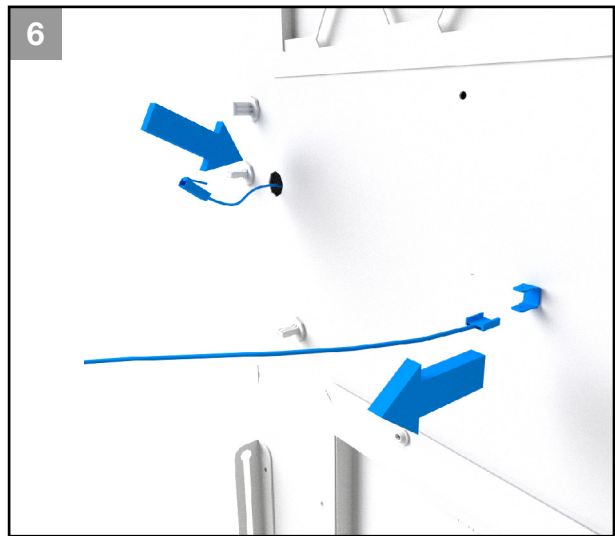
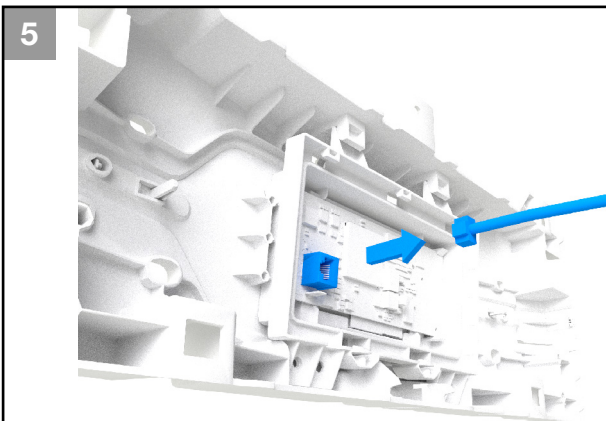
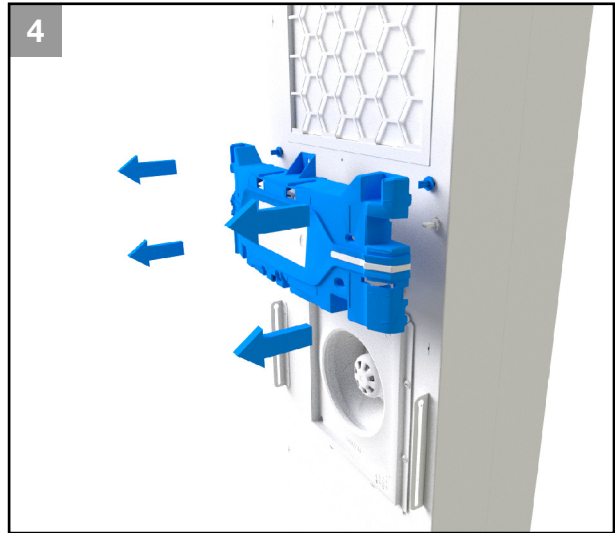
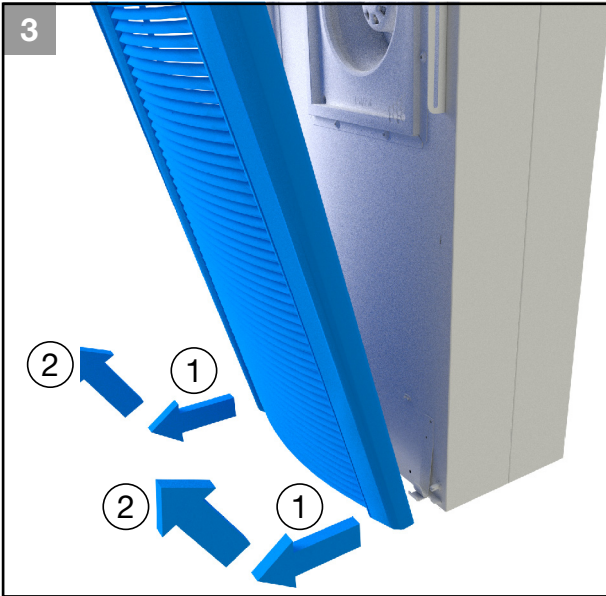

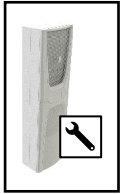

Kühlgerät als Teilbau montieren / Partial internal mounting of the cooling unit / Intégration partielle du climatiseur

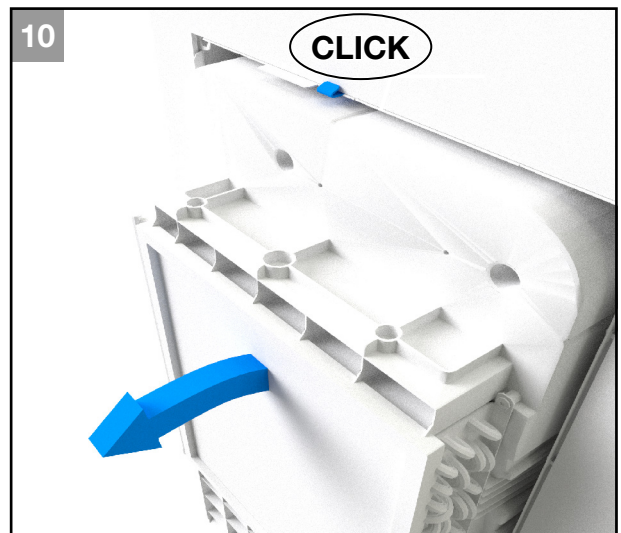
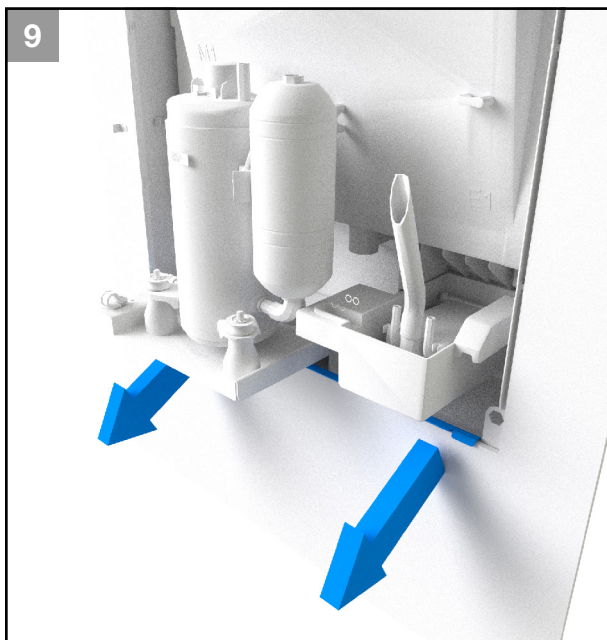
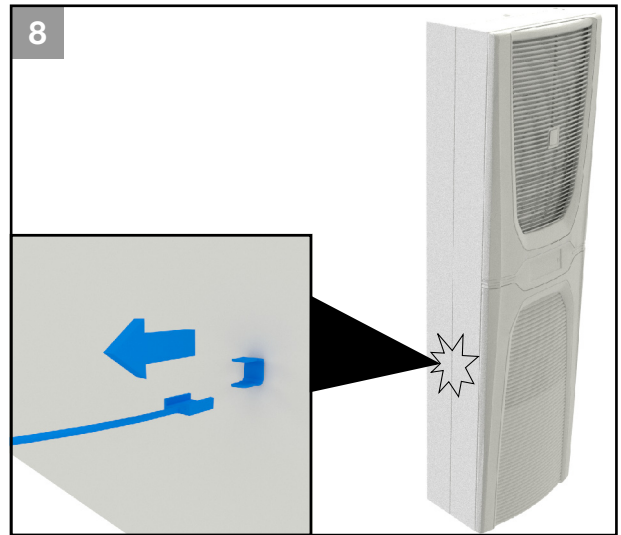
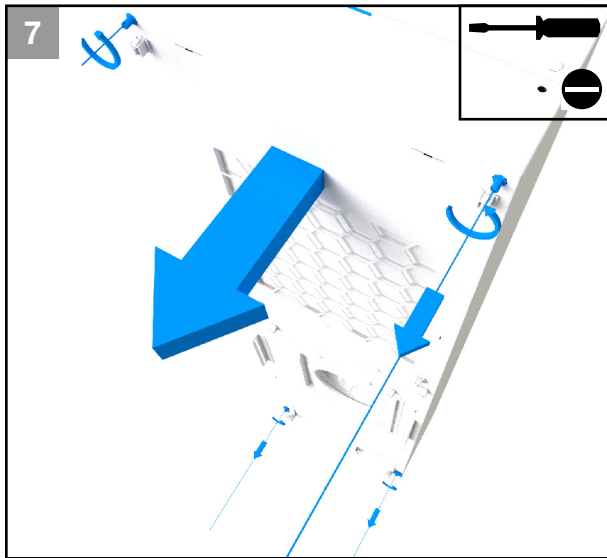

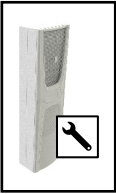

Kühlgerät als Teilbau montieren / Partial internal mounting of the cooling unit / Intégration partielle du climatiseur

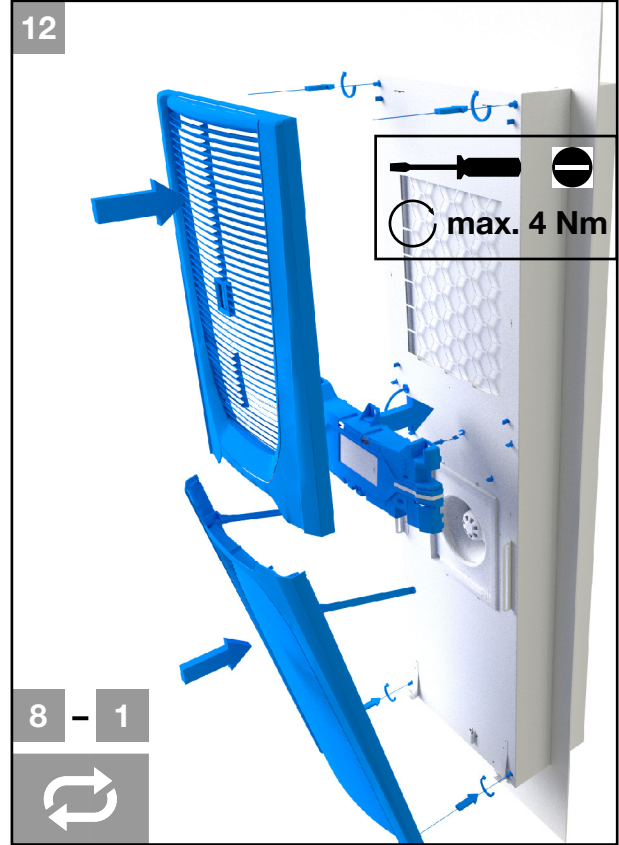
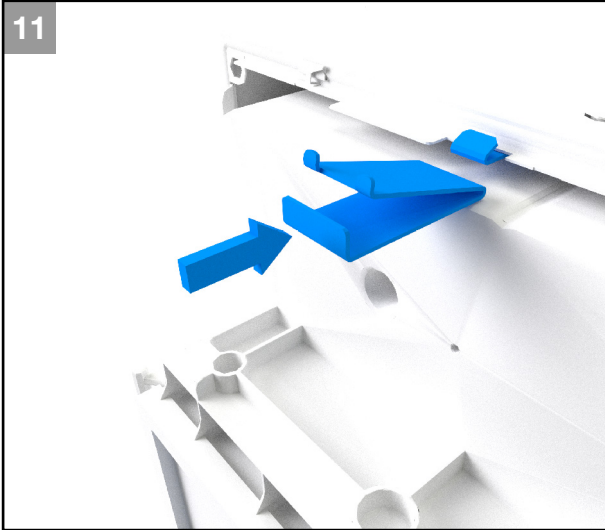

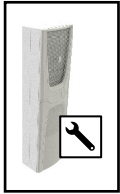

Kühlgerät als Vollenbau montieren / Full internal mounting of the cooling unit / Intégration complète du climatiseur

≥ 500 mm

SK 3185x30

≥ 600 mm







SK 3186x30

SK 3187x30

SK 3188x40

SK 3189x40

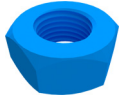

1 x		2 x		2 x		4 x	
4 x		2 x		2 x	SK 3185x30		
				6 x	SK 3186x30 SK 3187x30 SK 3188x40 SK 3189x40		

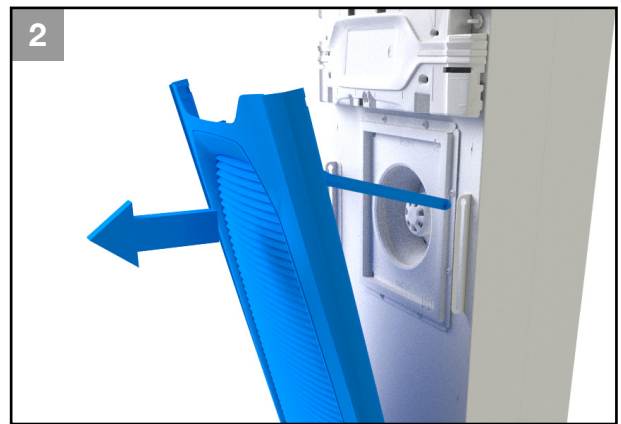
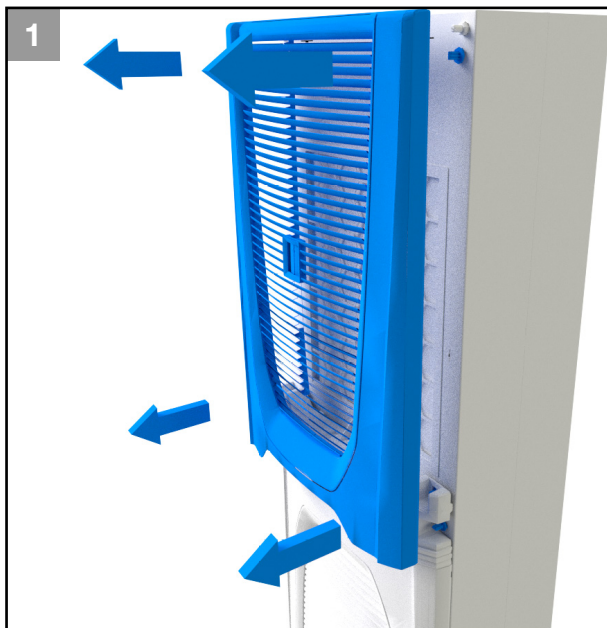

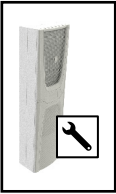

Kühlgerät als Vollenbau montieren / Full internal mounting of the cooling unit / Intégration complète du climatiseur

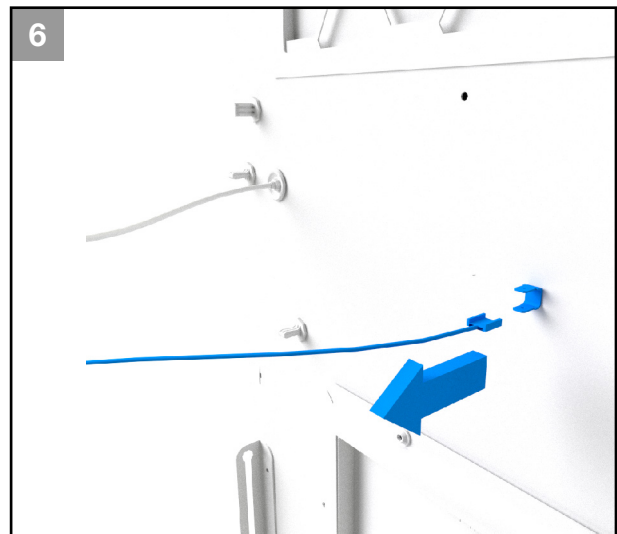
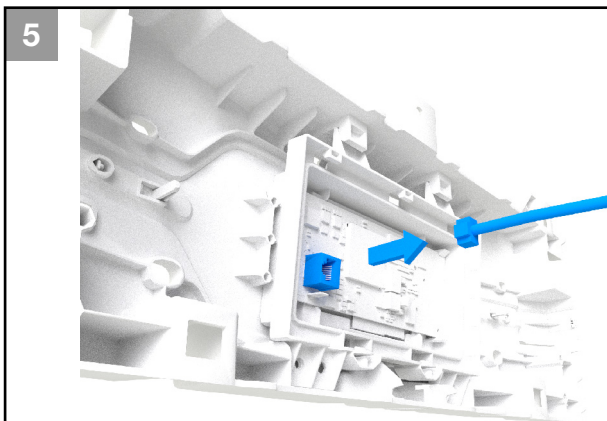
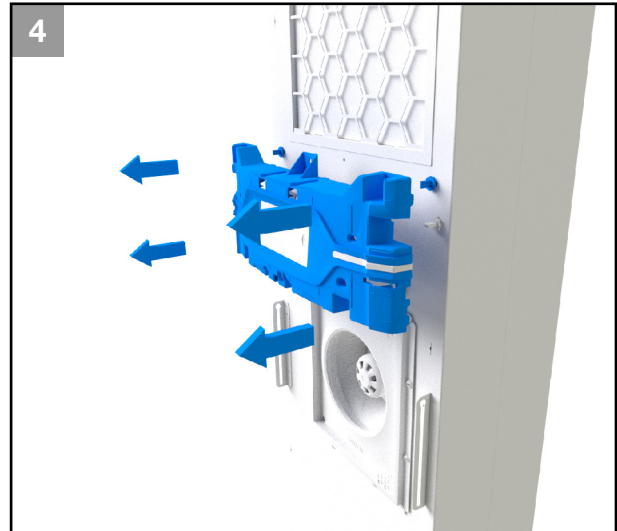
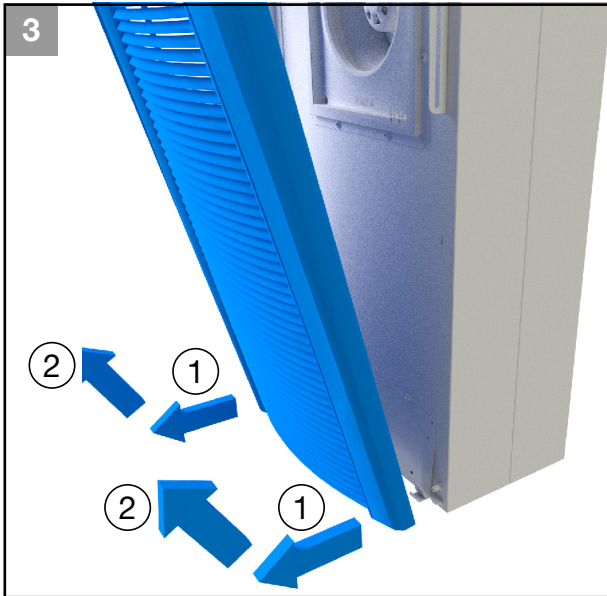



Kühlgerät als Volleinbau montieren / Full internal mounting of the cooling unit / Intégration complète du climatiseur

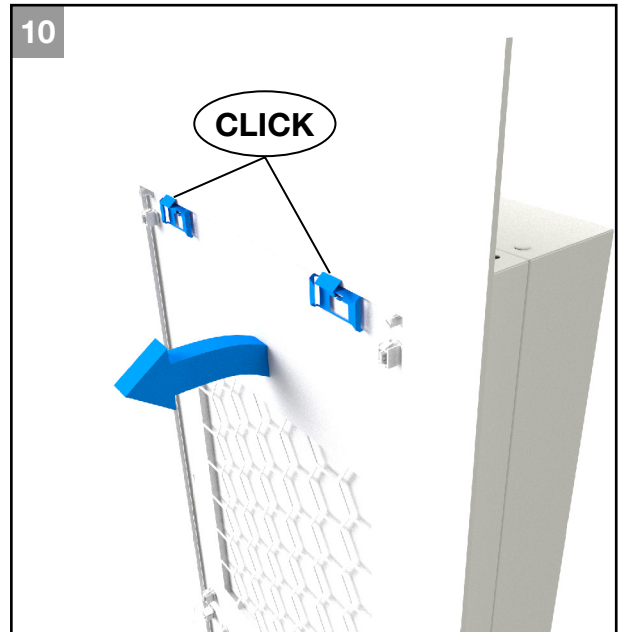
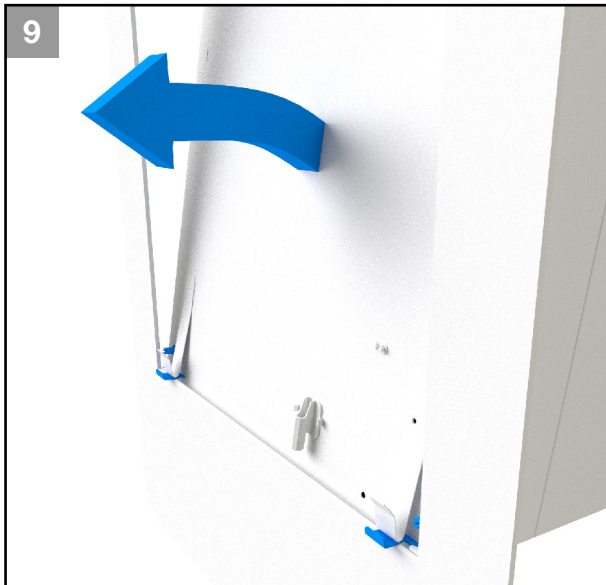
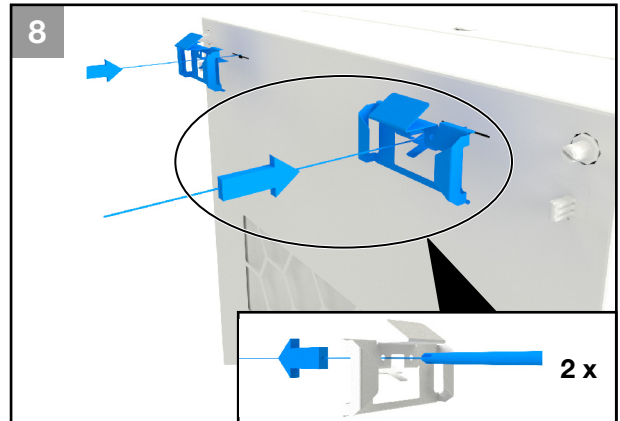

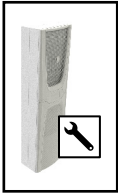

Kühlgerät als Vollenbau montieren / Full internal mounting of the cooling unit / Intégration complète du climatiseur

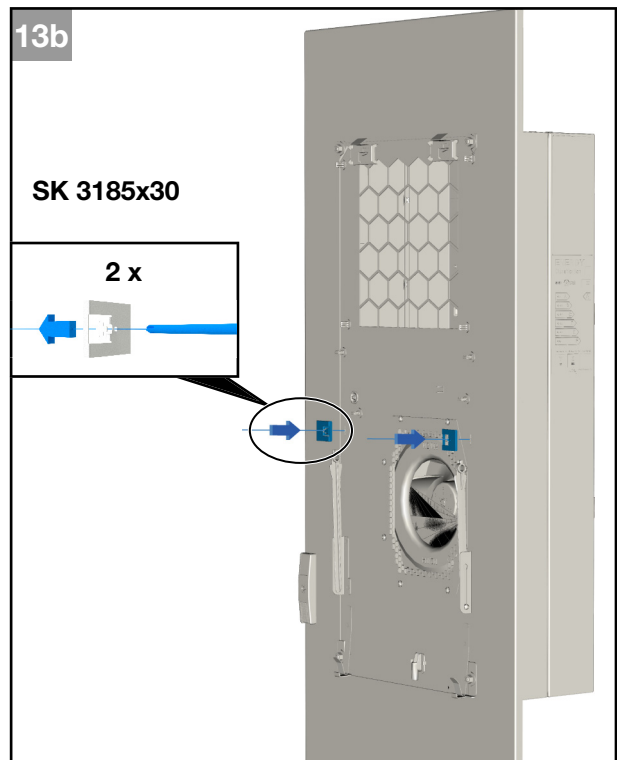
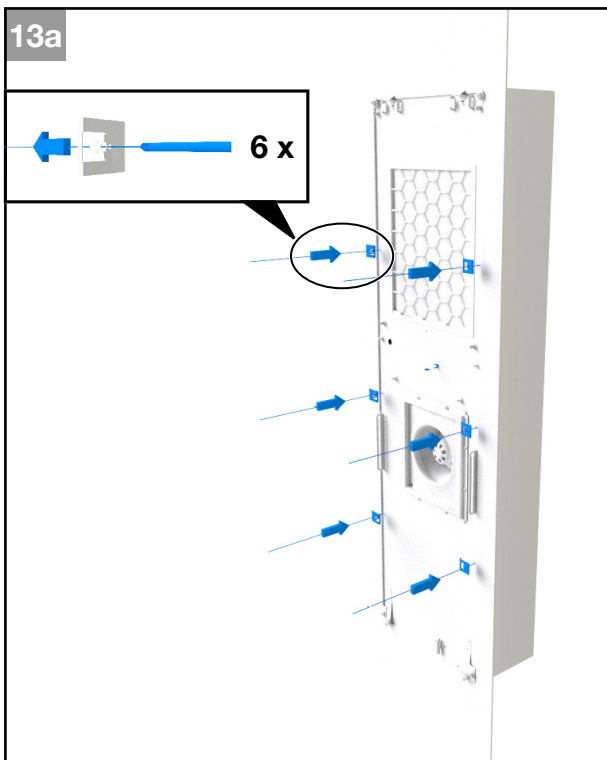
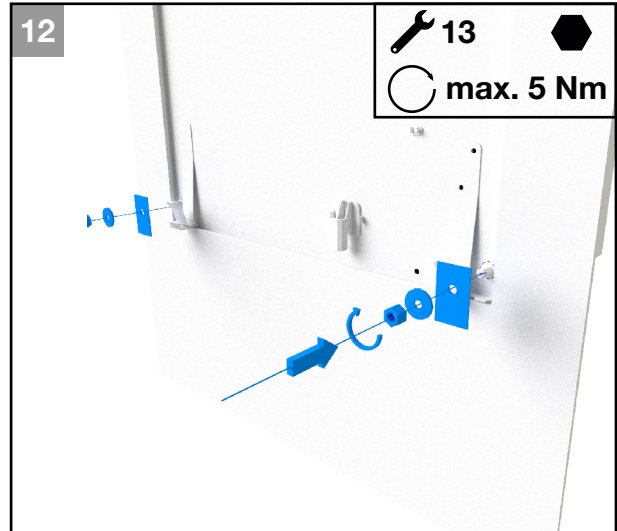
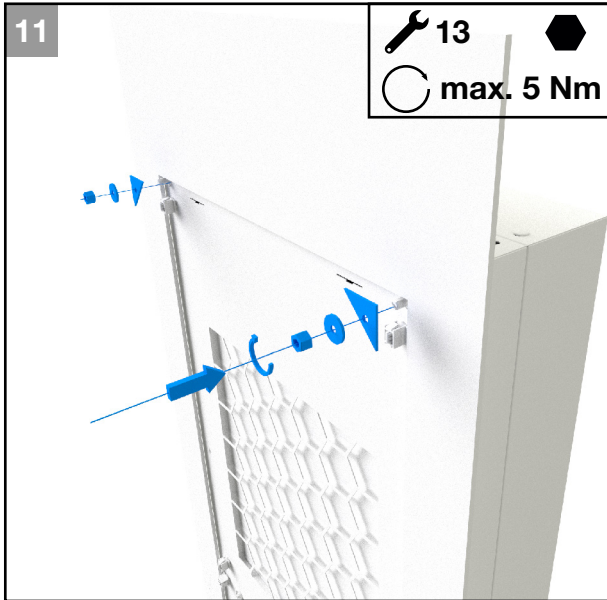

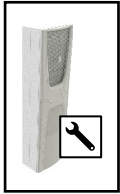

Kühlgerät als Volleinbau montieren / Full internal mounting of the cooling unit / Intégration complète du climatiseur



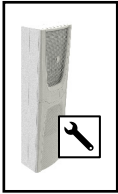

Kondensatwasserablauf anschließen / Connecting the condensate water discharge / Raccordement du tuyau d'évacuation des eaux de condensation

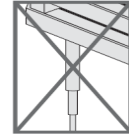
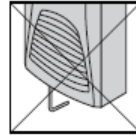

Hinweise zur Elektroinstallation / Notes on electrical installation / Instructions relatives à l'installation électrique



- Alle Kabel, die in der Anschlussbox zusammengeführt werden, müssen mindestens gemäß der Anschlussspannung des Gerätes isoliert sein.
- Das Kühlgerät muss über eine allpolige Trennvorrichtung nach Überspannungskategorie III (IEC 61058-1) an das Netz angeschlossen werden.
- Es wird empfohlen, die Netzzuleitung und das Signalkabel geschirmt auszuführen. Der Kabelschirm kann an der Hammerfußschiene kontaktiert werden.
- Damit die geräteinternen Sicherheitsorgane im Fehlerfall ordnungsgemäß funktionieren können, darf die Leistungsabsicherung nicht unter 15 A liegen und muss vom Typ „Träge (Time Delay)“ sein.
- Wenn ein Motorschutzschalter oder Leitungsschutzschalter genutzt wird, soll dieser nach EN 60898-1 ausgewählt werden (Auslösecharakteristik Typ D).
- All cables routed into the wiring compartment have to be insulated for the maximum voltage of the power supply.
- The cooling unit must be connected to the mains via an all-pole disconnect to overvoltage category III (IEC 61058-1).
- We recommend that the power supply cable and the signal cable should be of a shielded design. The cable shield can make contact with the T-rail.
- To ensure the proper functioning of internal pressostats in the event of a malfunction, a slow (time delay) line fuse of no less than 15 A is required.
- If a motor protection switch or circuit breaker is also used, it should be selected in compliance with EN 60898-1 (tripping characteristics type D).
- Tous les câbles, qui vont vers le boîtier de raccordement, doivent être isolés en fonction de la tension de raccordement de l'appareil.
- Le climatiseur doit être raccordé au réseau via un dispositif de séparation de tous les pôles, conformément à la catégorie de surtension III (CEI 61058-1).
- Nous recommandons l'utilisation de câbles blindés pour l'alimentation électrique et le câble de signalisation. Le blindage du câble peut être raccordé au rail en forme de tête de marteau.
- Pour que les organes de sécurité internes de l'appareil puissent fonctionner correctement en cas de défaut, le disjoncteur ne doit pas être inférieur à 15 A et il doit être du type « à action retardée (Time Delay) ».
- Lorsqu'un interrupteur de protection du moteur ou un interrupteur de protection de la direction est utilisé, il doit être sélectionné conformément à la norme EN 60898-1 (caractéristique de déclenchement type D).

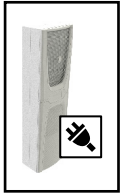

Elektrischer Anschluss / Electrical connection / Raccordement électrique

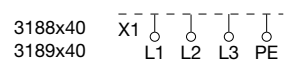
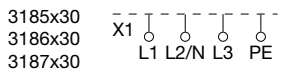
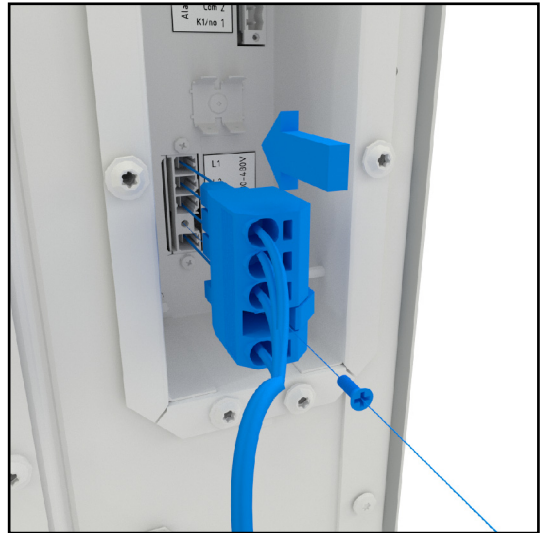
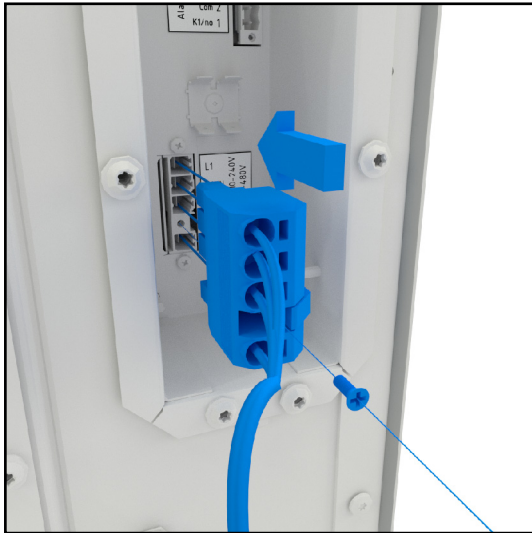

Türenschafter / Door limit switch / Contact de porte

Alarmrelais / Alarm relay / Relais de défauts

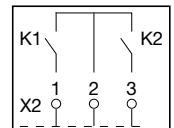
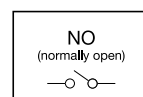
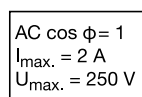
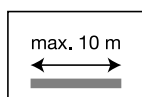
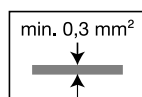
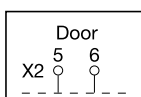



Zugentlastung / Strain relief / Décharge de traction

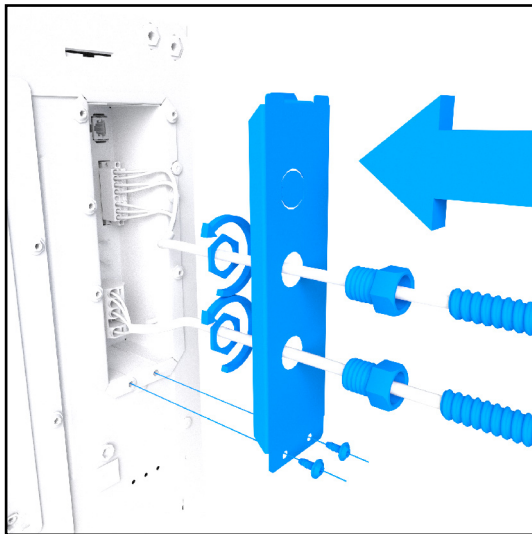
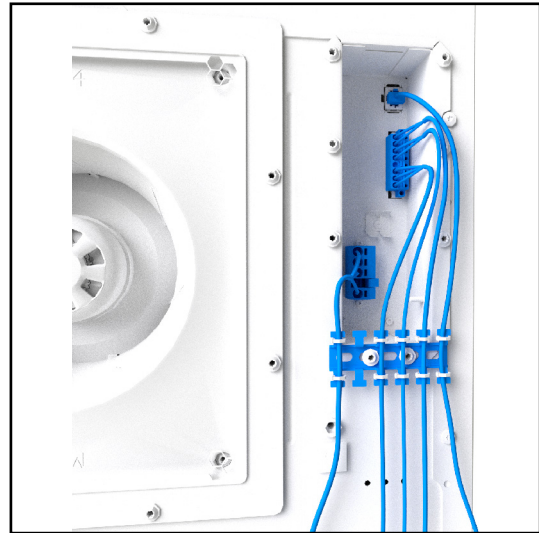
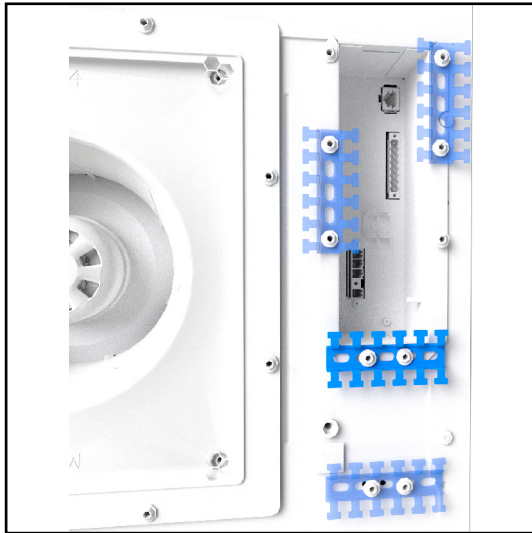

Verwenden Sie ausschließlich Kupferleitungen!
Use copper conductors only!
Utiliser exclusivement des câbles en cuivre !

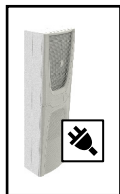

DE

EN

FR

Überspannungsschutz und Netzbelastung / Overvoltage protection and supply line load / Protection contre les surtensions et les surcharges

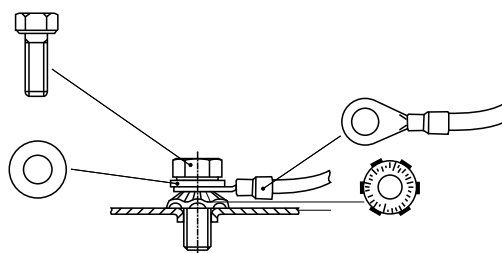
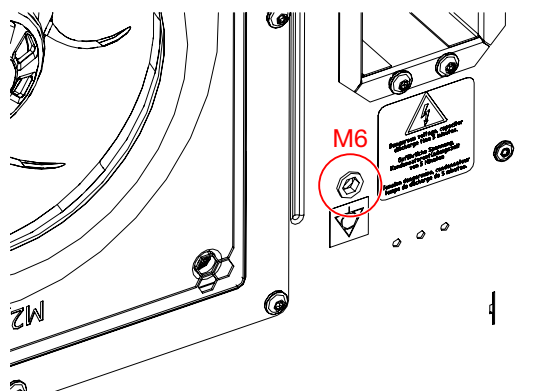

Der Schutzleiter in der Netzanschlussleitung gilt nach Norm nicht als Potenzialausgleichsleiter.

According to the standard, the PE conductor in the mains connection cable is not classed as an equipotential bonding conductor.

Selon la norme en vigueur, le fil de protection du câble d'alimentation ne peut faire office de câble d'équipotentialité.

Überspannungsschutz und Netzbelastung

- Das Gerät hat keinen eigenen Überspannungsschutz. Maßnahmen zum wirksamen Blitz- und Überspannungsschutz müssen netzseitig vom Schaltanlagenbauer bzw. Betreiber getroffen werden.
- Die Geräte sind in die Überspannungskategorie III eingestuft. Die Netzspannung darf nicht um mehr als die in Abschnitt „Technische Daten“ angegebene Toleranz abweichen.
- Der Ableitstrom kann 3,5 mA übersteigen.
- Die Geräte sind ab Werk hochspannungsgeprüft. Eine zusätzliche Hochspannungsprüfung in der Endanwendung darf ausschließlich mit einer DC-Spannungsquelle durchgeführt werden (max. 1500 VDC).
- Sind in dem Netz, in dem das Gerät betrieben wird, Frequenzrichter, Stromrichter oder Transformatoren mit einer Gesamtleistung >70 kVA in Verwendung, muss kundenseitig ein Class II Überspannungsableiter in der Netzzuleitung des Kühlgerätes vorgeschaltet werden. Die Auslegung des Überspannungsableiters sollte gemäß EN 61800-1 erfolgen. Als Anhaltspunkt für die Auslegung können folgende Werte angenommen werden:

Overvoltage protection and supply line load

- The unit does not have its own overvoltage protection. Measures must be taken at the supply end by the switchgear manufacturer or operator to ensure effective protection against lightning and overvoltage.
- The units are classified as overvoltage category III. The mains voltage must not deviate by more than the tolerance specified in section "Technical specifications".
- The discharge current may exceed 3.5 mA.
- The units are high-voltage tested ex works. An additional high voltage test must only be carried out with a DC voltage supply source (1500 VDC max.).
- If the combined output of the frequency converters, power converters or transformers in the network where the device is being operated is >70 kVA, the customer must connect a Class II surge voltage protector in the mains supply line upstream of the cooling unit. The surge voltage protector must be designed to EN 61800 -1. The following values may be assumed as starting-points for the design:

Protection contre les surtensions et les surcharges

- L'appareil ne dispose d'aucune protection contre les surtensions. Le tableautier ou l'exploitant se doit d'assurer une protection efficace contre la foudre et les surtensions.
- Les appareils sont classés dans la catégorie de surtension III. La tension du réseau ne doit pas sortir de la tolérance indiquée dans le paragraphe « Caractéristiques techniques ».
- Le courant de fuite peut dépasser 3,5 mA.
- Les appareils sont testés en usine au niveau de la haute tension. Un test haute-tension supplémentaire en tension continu (max. 1500 V CC) peut-être mené sur le lieu d'exploitation.
- Si le réseau électrique dans lequel est utilisé le climatiseur est équipé de variateurs de fréquence, de convertisseurs de puissance ou de transformateurs d'une puissance totale >70 kVA, le client doit monter en amont un parasurtenseur de catégorie II dans le câble d'alimentation secteur du climatiseur. Le parasurtenseur doit être dimensionné conformément à la norme EN 61800-1. Les valeurs ci-dessous peuvent être utilisées comme repères :

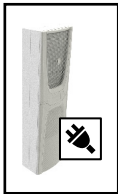

Transformatoren, Leistungselektronik Transformers, power electronics Transformateurs, électronique de puissance	Anzunehmende Ableitenergie Assumed discharge energy Énergie dissipée prévisible
70 kVA...100 kVA	40 J
100 kVA...200 kVA	80 J
200 kVA...400 kVA	160 J
400 kVA...800 kVA	320 J

Tab. 1: Auslegung des Überspannungsableiters / design of the surge voltage protector / dimensionnement du parasurtenseur

Drehstromgeräte

- Beim elektrischen Anschluss der Inverter-Geräte in Drehstromausführung muss nicht auf ein Links- oder Rechtsdrehfeld geachtet werden. Die in die Geräte integrierte Elektronik bildet das erforderliche Drehfeld selbständig.
- An dreiphasigen Geräten wird der Ausfall einer Phase erkannt und das Gerät wird abgeschaltet.
- Abgehende Verbraucher werden vom Inverter stromseitig überwacht und bei Fehler abgeschaltet.

Three-phase devices

- There is no need to observe a counterclockwise or clockwise phase rotation when making the electrical connection for inverter devices in the three-phase version. The electronics incorporated into the devices automatically create the required phase rotation.
- In three-phase devices, the absence of a phase is detected, and the device is switched off.
- Outgoing equipment is monitored by the inverter, and deactivated in the event of a malfunction in the electricity supply.

Appareils à alimentation triphasée

- Il n'est pas nécessaire de tenir compte du sens de rotation du champ magnétique lors du raccordement de l'inverter au courant triphasé. L'électronique intégrée crée elle-même le sens de rotation nécessaire.
- Sur les appareils triphasés, toute panne d'une phase est détectée et l'appareil est mis hors fonction.
- Les récepteurs sont surveillés électriquement par l'inverter et mis hors fonction en cas de défaut.

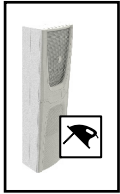

Montageausbrüche / Mounting cut-outs / Découpes de montage

SK 3185x30

Kontur des Kühlgeräts
Contour of the cooling unit
Contour du climatiseur

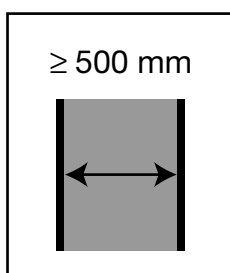
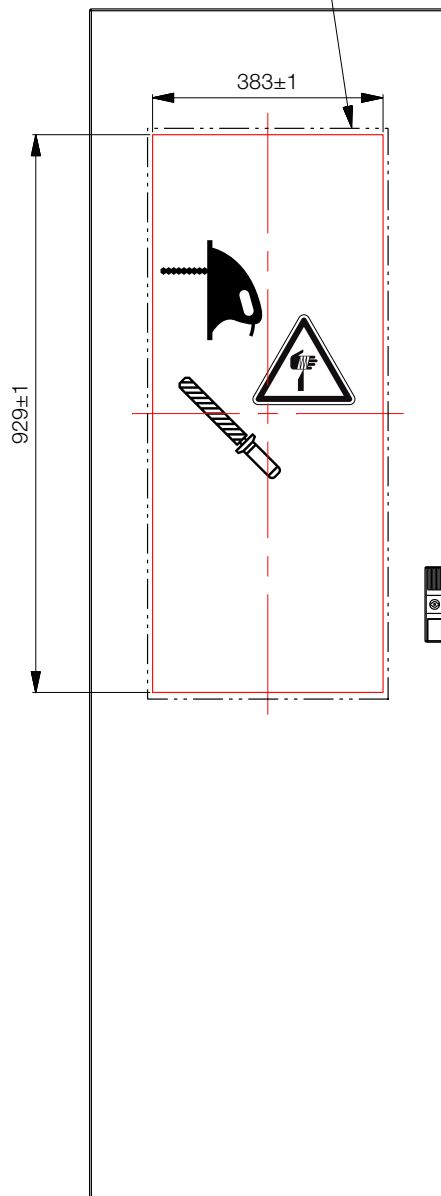

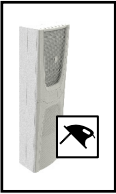

Montageausbrüche / Mounting cut-outs / Découpes de montage

SK 3186x30/SK 3187x30/SK 3188x40/SK 3189x40

Kontur des Kühlgeräts
Contour of the cooling unit
Contour du climatiseur

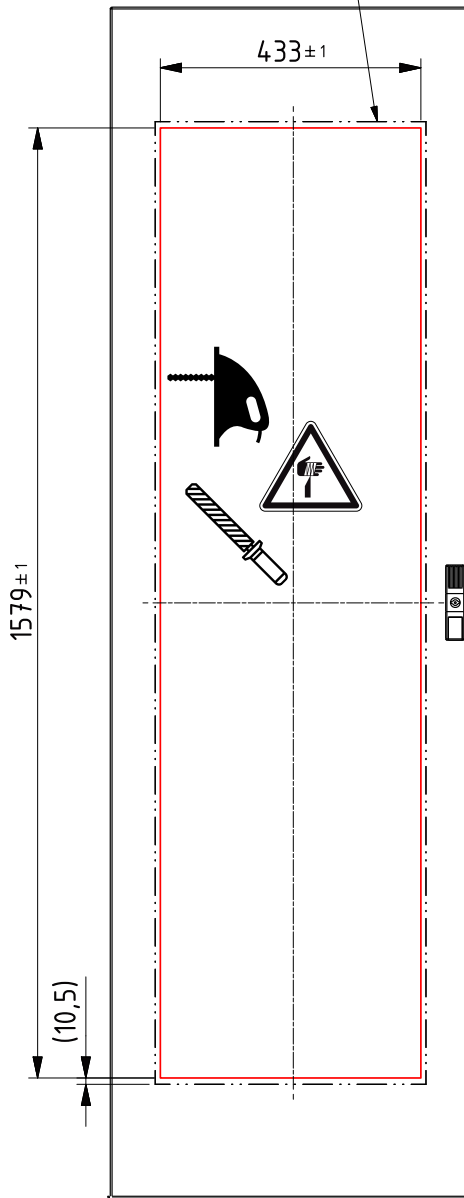

Kontur des Kühlgeräts
Contour of the cooling unit
Contour du climatiseur

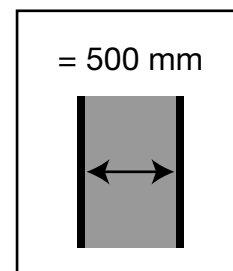
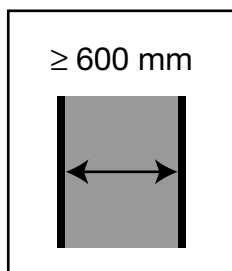
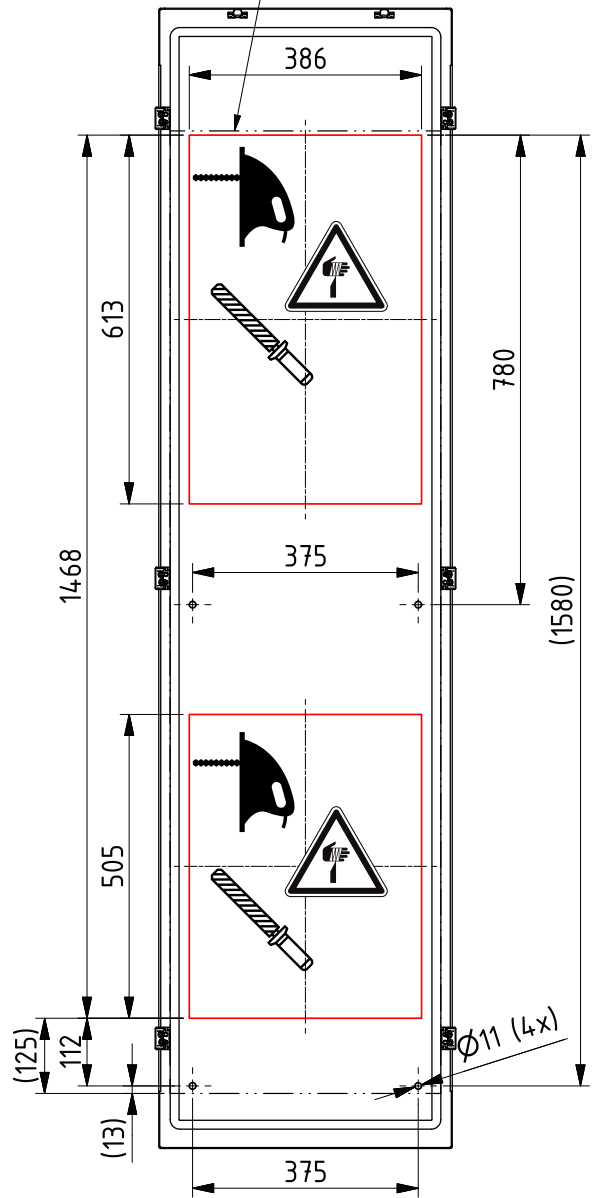

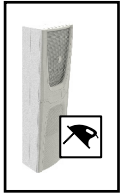

SK 3185x30

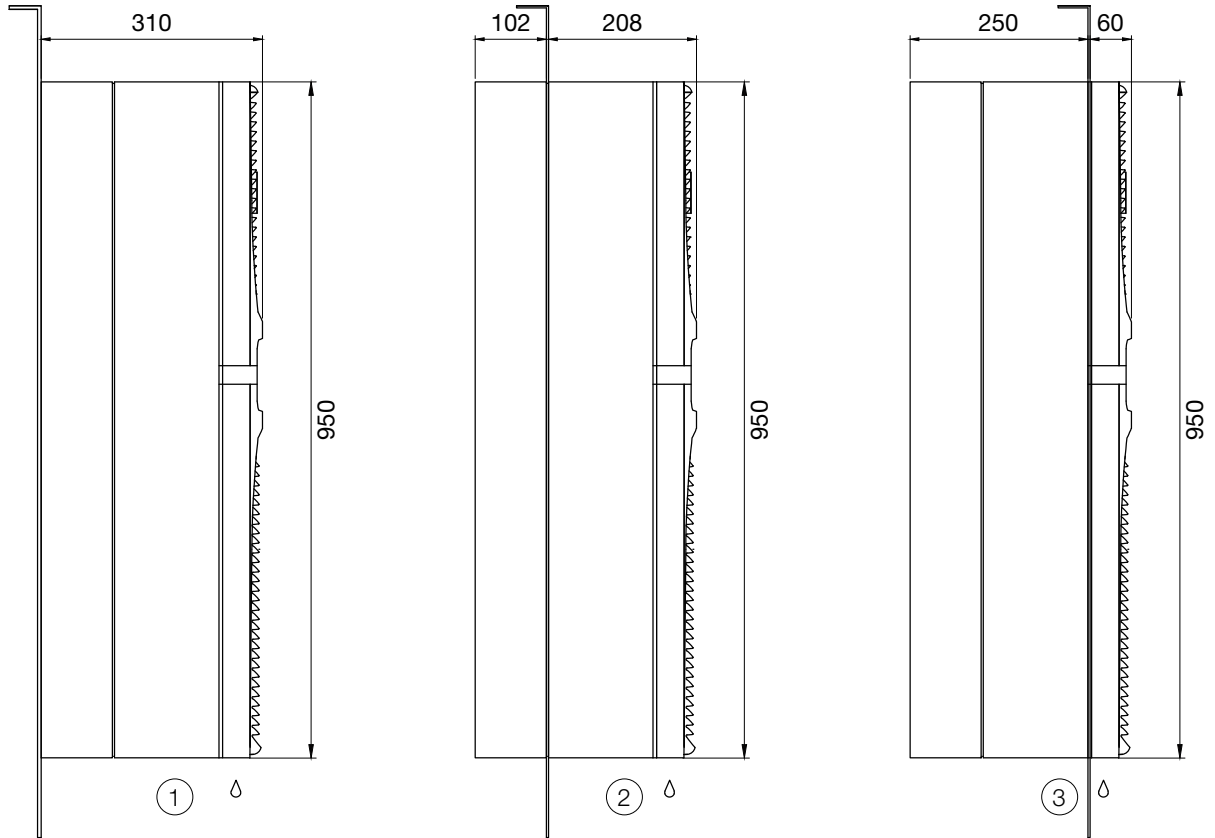

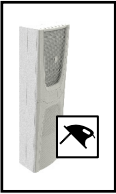

SK 3186x30 & SK 3187x30

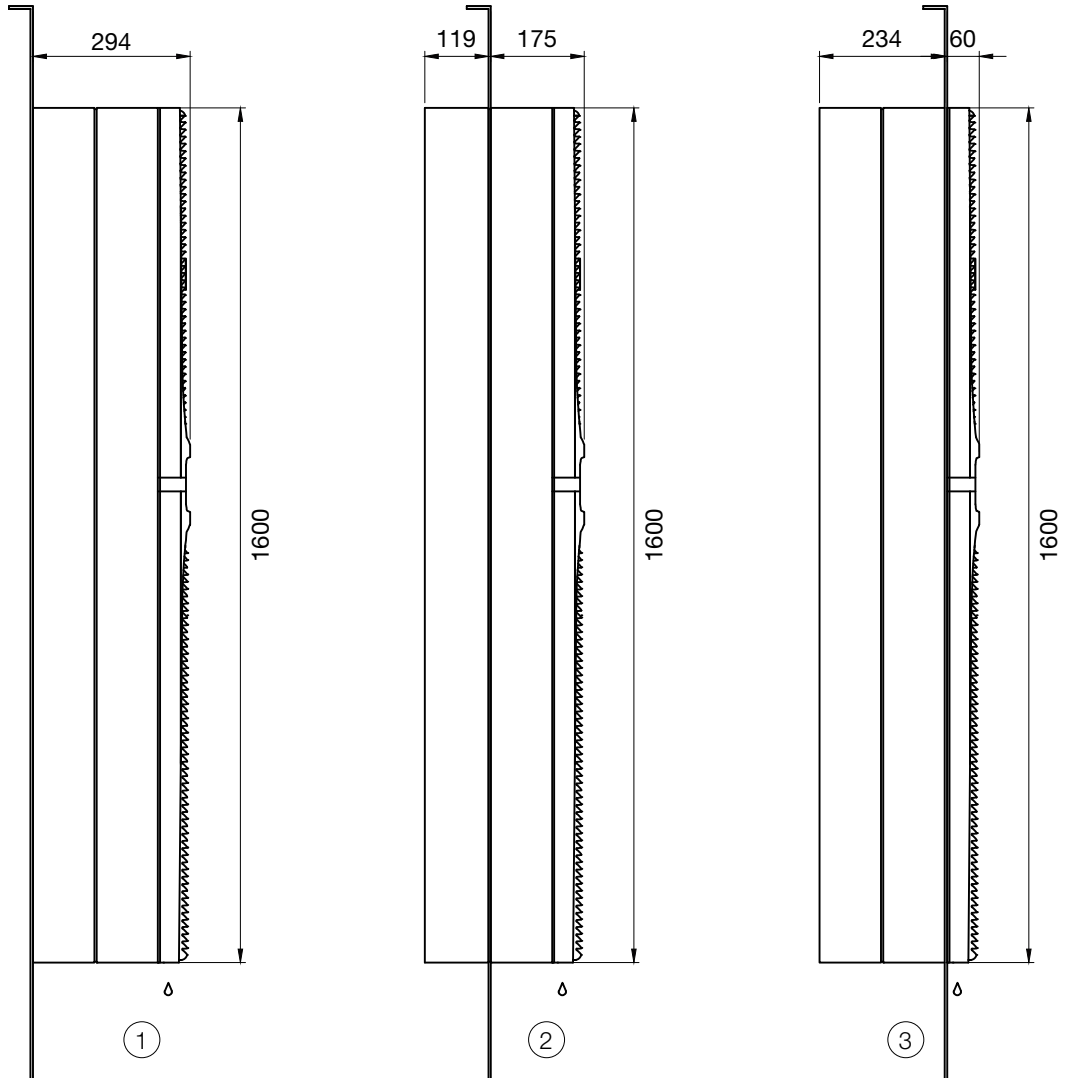

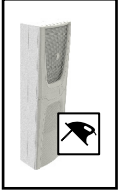

SK 3188x40 & SK 3189x40

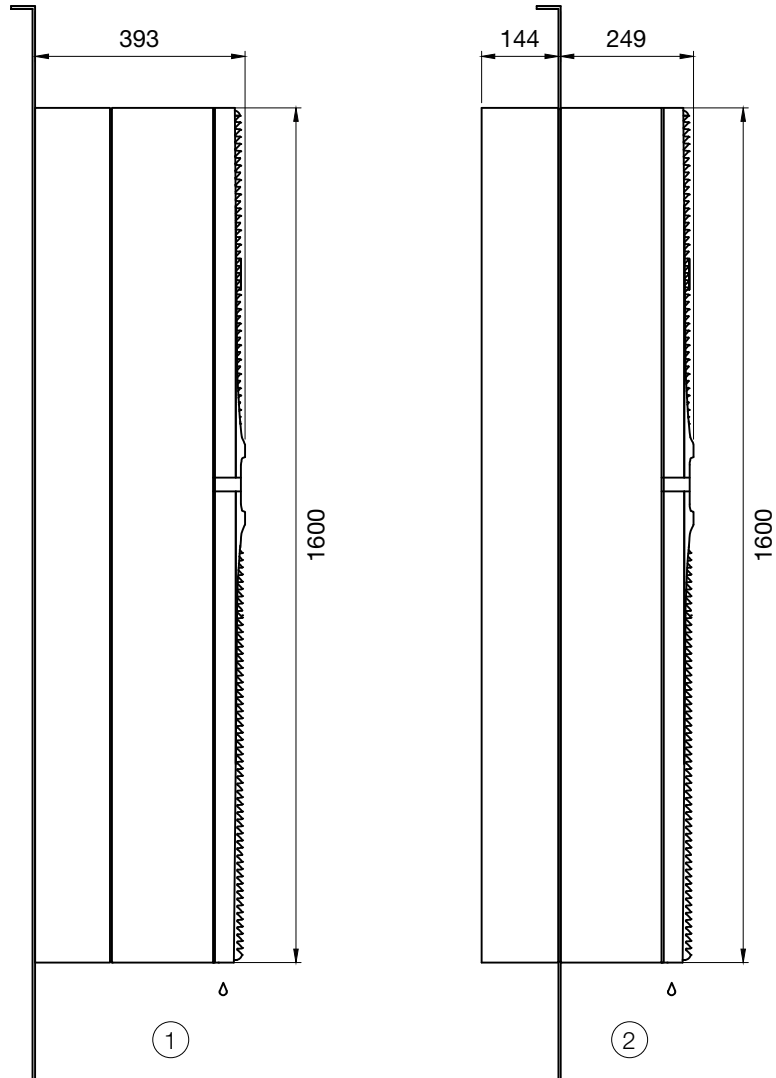

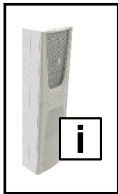

Konformitätserklärung / Declaration of conformity / Déclaration de conformité

Vereinfachte EU-Konformitätserklärung / Simplified EU Declaration of Conformity



Wir, / We,

Rittal GmbH & Co. KG • Auf dem Stützelberg • 35745 Herborn Erklären, dass die

Produkte / declare that the products

**Schaltschrank-Kühlgeräte
Enclosure cooling units**

SK 3185830, SK 3186930, SK 3187930, SK 3188940, SK 3189940
SK 3185530, SK 3186630, SK 3187630, SK 3188640, SK 3189640

folgenden Richtlinien entsprechen:
conform to the following directives:

Maschinenrichtlinie 2006/42/EG - Machinery Directive 2006/42/EC

EMV-Richtlinie 2014/30/EU - EMC Directive 2014/30/EU

Bei einer nicht mit uns abgestimmten Änderung des Produkts verliert diese EU-Konformitätserklärung ihre Gültigkeit. In case of any amendments to the assembly not explicitly agreed with us, this EU declaration of conformity shall be invalidated.

Die vollständige und unterschriebene EU-Konformitätserklärung erhalten Sie auf der Produktseite der Rittal Homepage www.rittal.com. The complete and signed declaration of conformity can be obtained from the product site of the Rittal homepage www.rittal.com

SCHALTSCHRÄNKE

STROMVERTEILUNG

KLIMATISIERUNG

IT-INFRASTRUKTUR

SOFTWARE & SERVICE

FRIEDHELM LOH GROUP

Seite 1 von 1

Rittal – The System.

Faster – better – everywhere.

- Enclosures
- Power Distribution
- Climate Control
- IT Infrastructure
- Software & Services

1st edition 08.2018 / ID no. 340829 / Document no. D-0000-00001628-00.pdf

You can find the contact details of all Rittal companies throughout the world here.



www.rittal.com/contact

RITTAL GmbH & Co. KG
Postfach 1662 · D-35726 Herborn
Phone +49(0)2772 505-0 · Fax +49(0)2772 505-2319
E-mail: info@rittal.de · www.rittal.com



ENCLOSURES

POWER DISTRIBUTION

CLIMATE CONTROL

IT INFRASTRUCTURE

SOFTWARE & SERVICES

FRIEDHELM LOH GROUP