

Rittal – The System.

Faster – better – everywhere.

Crimping machine L8



AS 4050.452

Operating instructions

ENCLOSURES

POWER DISTRIBUTION

CLIMATE CONTROL

IT INFRASTRUCTURE

SOFTWARE & SERVICES

FRIEDHELM LOH GROUP



Contents

1	About this documentation.....	3
2	General safety instructions	4
2.1	Intended use.....	4
2.2	The following is not permitted.....	4
2.3	Machine dangers.....	4
2.4	Operational hazards.....	4
2.5	Hazard sources	4
2.6	Safety equipment.....	5
2.7	Warning signs at and on the machine or components.....	5
2.8	Residual risks	5
2.9	Safety measures at the installation site	5
2.10	Notes for the operating company.....	5
2.11	Noise	6
3	Device description.....	6
3.1	Overview.....	6
3.2	Technical data.....	7
4	Operating instructions.....	8
4.1	Setting up the machine.....	8
4.2	Switch on the machine	9
4.3	Menus	9
4.4	Conductor insertion / conductor cutting.....	11
5	Tools.....	12
5.1	Ferrule feed	12
5.2	Triggering unit.....	13
5.3	Insulation stripping blade and cam.....	13
6	Maintenance	14
6.1	Maintenance notes.....	14
6.2	Daily maintenance.....	14
6.3	Weekly maintenance	15
6.4	Monthly maintenance.....	18
6.5	Quarterly maintenance.....	21
6.6	When required	22
7	Troubleshooting.....	22
7.1	Machine does not start.....	22
7.2	No start for inserted wire.....	22
7.3	The wire is only stripped.....	23
7.4	Large number of rejects.....	23
7.5	Error messages.....	23
8	Pneumatic connection diagram	26
9	Electrical connection diagram	27
10	Spare parts	28
11	Disposal.....	28

1 About this documentation

The warnings in this documentation are structured differently depending on the severity of danger.



Warning!

Possible risk of fatality!

Notices with the signal word "warning" warn you about situations which could lead to fatal or serious injuries if you do not pay attention to the notices specified.



Caution!

Risk of injury!







Notices with the signal word "caution" warn you about situations which could lead to injury if you do not pay attention to the notices specified.

Attention!

Property damage!

Notices with the signal word "attention" warn you about dangers which could result in damage to property.

Situation-related warnings may contain the following warning symbols:

Symbol	Meaning
	Warning: dangerous electrical voltage
	Warning: injury to hands due to sharp blades
	Work may only be performed by a qualified electrician
	Only perform work with personal protective equipment
	Disconnect the mains plug
	Notes on documentation

Additional formatting is used in the rest of the text which has the following meaning:



Note:

This constitutes information which is not related to safety, but which provides important information regarding correct and effective work.

- This symbol indicates an "action point" and shows that you should perform an operation or procedure.

- Bullet points are indicated with dashes.

Operating instructions in other languages can be found on our website:



Click here!

2 General safety instructions

2.1 Intended use

The crimping machine L8 is an electro-pneumatic crimping machine designed exclusively for stripping insulation from flexible conductors in accordance with DIN 60228:2005 and for crimping loose wire end ferrules with plastic collars (size 0.5 – 2.5 mm² / length 8). For this reason, because of its construction, the machine has only this intended use.

For the intended use, the following must be observed:

- All notes from the operating instructions
- The documentation of the supplied products, as well as
- The notes for servicing/maintenance

Any other use is deemed improper.

The details in section 3.2 "Technical data" as well as in the original documentation for any accompanying supplied products must be observed and adhered to.

An improper use of the product is not known to the manufacturer.

The manufacturer is not liable for any damage resulting from inappropriate or unintended use.

2.2 The following is not permitted

- Removing notification or warning signs.
- Opening the machine during operation.
- Using the machine with obvious defects or damage.
- The insertion of objects that are not conductors.

2.3 Machine dangers

A risk evaluation with subsequent safety inspection and safety acceptance was performed on the crimping machine L8.

2.4 Operational hazards

The operator may rectify only those faults for which the housing does not need to be removed.

- The machine must be disconnected from the power grid before changing tools or spare parts.

2.5 Hazard sources

- Before performing servicing, maintenance and cleaning work on the machine, switch off the machine, disconnect it from the power supply (e.g. cut off the electricity supply, switch off the fuse).



Caution!

Risk of injury due to missing safety equipment!

- Never remove safety equipment or decommission it by making changes to the machine.

2.6 Safety equipment

Safety equipment is installed to protect personnel. The operating company is obliged to inspect the safety devices annually.

- Housing: After removal of the housing, ensure that the earthing wire is inserted before the machine is closed again. The housing may be removed only by specialists or qualified personnel.
- Switched-mode power supply: The SMPS protects against dangerous voltages, because not more than 60 VAC or 110 VDC may be present.

Under no circumstances may safety devices be changed, removed or circumvented by changes to the machine.

2.7 Warning signs at and on the machine or components

- PE conductor connection: This marking is placed on the earth screw.

Symbol	Meaning
	The protective earth is a measure that in the event of a fault protects against dangerous touch voltage and electrical shock. The "protective earth" measure is provided by the protective conductor.

The connection is made via an IEC connector with leading protective conductor contact. The "PE" protective conductor (green/yellow insulating sheath only in Germany) is used for these protective measures.

2.8 Residual risks

Even when all safety and warning notes are observed, residual risks remain for the machine operation.

The machine is state-of-the-art and built according to recognised safety regulations. Nevertheless, hazards for users or third-parties can result when operating the machine.

- The machine may be used only for the intended purpose.
- The machine must be in proper safety condition during commissioning.



Warning!

Electrical shock caused by working on live components!

- Only authorised personnel may perform work on electronic components.

2.9 Safety measures at the installation site

The machine must be placed stable on a table.

- There is a large hazard risk should a machine fall.



Note:

Inner-company instructions and checks should ensure that the workplace and its vicinity remain clean and uncluttered.

2.10 Notes for the operating company

- The operating company is obliged to write operating instructions.
- The operating company is obliged to inspect the safety devices annually.

3 Device description

EN

- Deploy only original fuses with the specified amperage.
- Knowledge of the local, operational safety and accident-prevention regulations.
- All notes on machines must be kept legible, and renewed when necessary.
- Notify the manufacturer without delay should defects become apparent, provided they were not caused intentionally.
- Any imperfect machine parts must be replaced immediately.

2.11 Noise

The A-weighted equivalent continuous sound pressure level of the L8 crimping machine is ≤ 70 dB(A).

Consequently, ear muffs are not required for operating the machine.

3 Device description

3.1 Overview

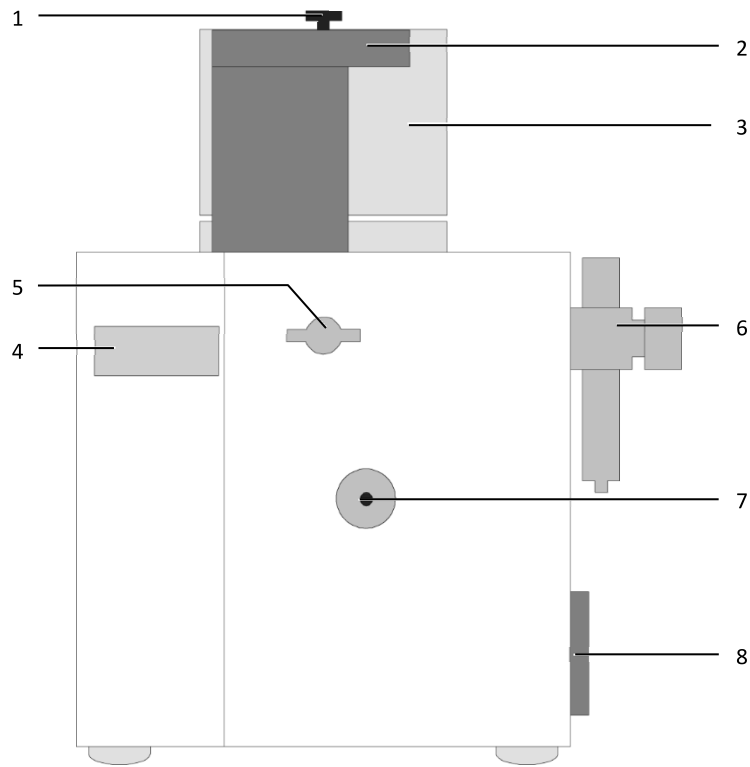

Fig. 1: Overall view

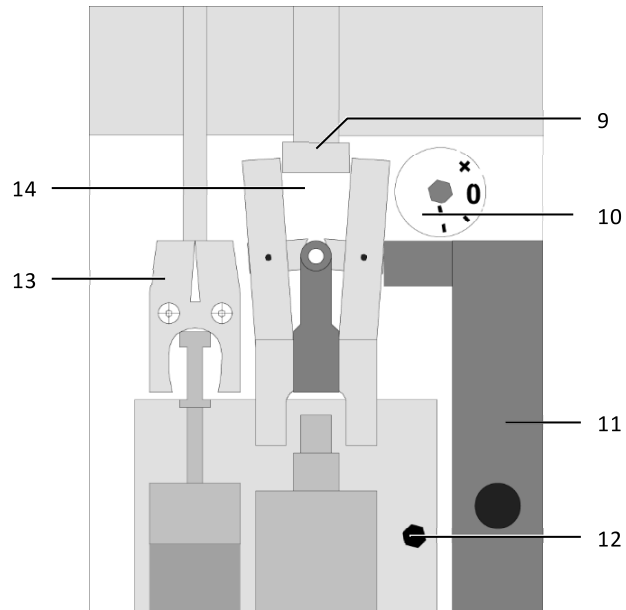

Fig. 2: Interior view

Key

- 1 Setting button
- 2 Separating unit
- 3 Vibrating conveyor (VC) upper part
- 4 Touch display
- 5 Twist lock
- 6 Maintenance unit
- 7 Insertion funnel
- 8 Mains filter module
- 9 Opening wedge
- 10 S1 setting
- 11 Stripped insulation scrap container
- 12 Hexagonal spanner
- 13 Tool unit (ferrule holding unit, crimping unit)
- 14 Cable feeding unit

3.2 Technical data

	AS crimping machine L8
Feeding length	27 mm + crimping length
Cross-section	0.5...2.5 mm ² (20...14 AWG)
Crimping form	Trapezoidal
Drive	Electro-pneumatic
Voltage	100...240 V
Frequency	50/60 Hz
Power consumption	100 VA
Fuse (mains filter module)	2 x T2AH250V
Operating pressure	5.5 bar
Air consumption per cycle	approx. 0.9 l

4 Operating instructions

EN

	AS crimping machine L8
Degree of protection	IP 20
Cycle time	approx. 1.0 s
Continuous sound pressure level	≤70 dB(A)
Dimensions (W x D x H)	390 x 330 x 460 mm
Colour	RAL 9003
Weight	31 kg
Interfaces	Touch display
Operating environment	
Storage/transport temperature	-25 °C...+55 °C
Ambient temperature	+5 °C...+40 °C
Operating temperature	+10 °C...+45 °C
Max. operating altitude	2000 m above mean sea level
Humidity	50% at 40 °C (without dewing) 90% at 20 °C (without dewing)
Contamination level	2
Pressure safety equipment	85%...110 %

4 Operating instructions

4.1 Setting up the machine

- Read the operating instructions carefully before commissioning the machine.
- Deploy the machine only in a dry environment.

Attention!

The electrical data shown on the rating plate must match that of the power grid. Otherwise, damage can occur to the machine.



Warning!

Electrical shock caused by working on live components!

- Disconnect the mains plug and separate the machine from the pneumatic network.



Note:

- Before processing, clean the stranded wires to remove lubricants (e.g. talcum).

The machine is equipped with a compressed-air maintenance unit (compressed-air filter and regulating valve). It can be connected directly to the compressed-air supply.

- Connect the mains cable to the machine and to the power supply.

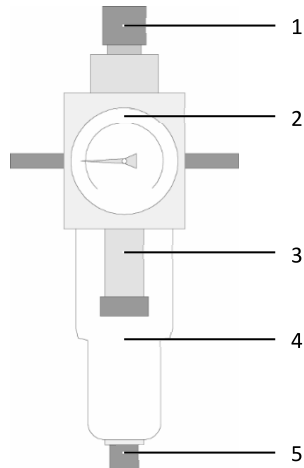

Fig. 3: Maintenance unit

Key

- 1 Setting button
- 2 Manometer
- 3 Filter element
- 4 Container
- 5 Manual drain

4.2 Switch on the machine

- Switch on the mains switch at the mains filter module.
Menu 1 appears in the display.

4.3 Menus

- ⬆️ ⬇️ Up or down
- Select E

Operating menu

Ready/Strip/Crimp	VC: %
Status display	Vibrating conveyor (VC) power
Day quantity count	(C 5 s: delete)
Error message First number Second number	S: 1/0 (step) Stripping-crimping Feed

Vibrating conveyor (VC) power

Display in %	
⬆️	Increase power
⬇️	Decrease power

- 120 V: VC power approx. 54%
- 230 V: VC power approx. 27%

4 Operating instructions

EN

- Select E.
Cursor flashes.
- Set the value with **↑** **↓**.
- Confirm E.

To load the infeed belt:

- When the **↑** key is held down, the VC value increases to the highest value.
- After releasing the **↑** key, the VC power returns after 3 seconds to the stored VC value.

Insulation stripping program

0	Stripping and crimping
1	Stripping only

After switching on the machine, the "Stripping = 0" program is set. If the "Stripping = 1" program is selected, this is displayed in the Operating menu.

Quantity counter and processing time

Tot. ct.:	Total quantity count
Mach. time:	Machining time of a cycle in ms
Service:	Shows the quantity still to be processed until the next service.

Test inputs

No., status	1 or 0
Name of the component	

Test outputs

No., status	1 or 0
Name of the component	
For simulating:	C = 0, E = 1

General data

Step times

PC data

Language

1: German

2: English

3: French

4: Italian

5: Dutch







4.4 Conductor insertion / conductor cutting

Inserting the conductor in the insertion funnel triggers the work cycle.

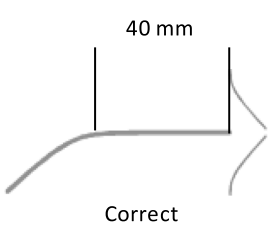

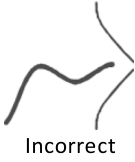
Note:

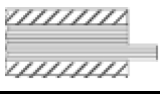
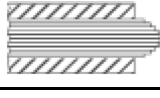
The cable must be cut straight and must not have any kinks or bends.

 <p>40 mm</p> <p>Correct</p>	Correct	Incorrect	
			Inclined cut
 <p>Incorrect</p>			Protected conductor
			Pulled-out conductor
			Crushed conductor
			Recessed conductor



Tab. 1: Conductor insertion / conductor cutting



5 Tools

5.1 Ferrule feed

The ferrule feed consists of the vibrating conveyor upper part, the separating unit and the feed pipe.

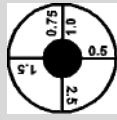
- Loosen the screw in the middle of the vibrating conveyor upper part, turn it counter-clockwise and raise it for changing.
- To set the separating unit, pull the button upwards and turn.
- Fasten the vibrating conveyor upper part again.
- Fill the wire end ferrules.
- Call program 2 "Vibrating conveyor power".
- To load the infeed belt: press the  key until the required power of the vibrating conveyor is attained and keep pressed. After releasing the key, the power returns to the stored value.
- Set the feed speed so that an adequate supply with ferrules is guaranteed. The first wire is only stripped of its insulation.

 <p>Wire end ferrule</p>	 <p>Vibrating conveyor (VC) upper part</p>	 <p>Separating unit</p>
0.5 / 8 N	1	0.5
0.5 / 8 S	1	0.75 – 1.0
0.75 / 8 N	1	0.75 – 1.0
0.75 / 8 S	1	0.75 – 1.0

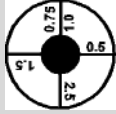
 Wire end ferrule	 Vibrating conveyor (VC) upper part	 Separating unit
1.0 / 8 N	1	0.75 – 1.0
1.0 / 8 S	1/2	1.5
1.5 / 8 N	1/2	1.5
1.5 / 8 S	2	2.5
2.5 / 8 N	2	2.5
2.5 / 8 S-XS	2	2.5

Tab. 2: Setting overview

5.2 Triggering unit

- Open the front panel.
- Pull the tool unit forwards.
- Place the setting wheel of the triggering unit at position "0", "+", "-" or "—".
 - "0" is the standard feeding length.
 - "+" lengthens the feeding length (turn clockwise).
 - "-" shortens the feeding length.
 - "—" shortens the feeding length more to prevent stranded-wire protrusion (turn counter-clockwise).

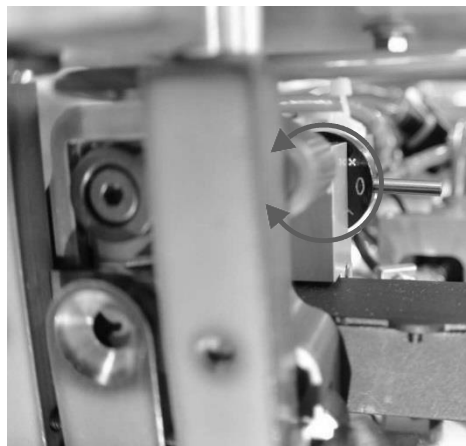

Fig. 4: Setting the triggering unit

5.3 Insulation stripping blade and cam



Caution!

There is risk of finger injuries at the insulation stripping blades.

- Never touch the blade.

- Remove the fastening screws (2x).
- Remove the cam.
- Remove the cover.
- Remove the blade with tweezers.
- Install in the reverse sequence.

Depending on the strength and thickness of the insulation, the cam must be adjusted in the "+" or "-" direction.

- To cut less, move the cam in the "+" direction; to cut more, move the cam in the "-" direction.

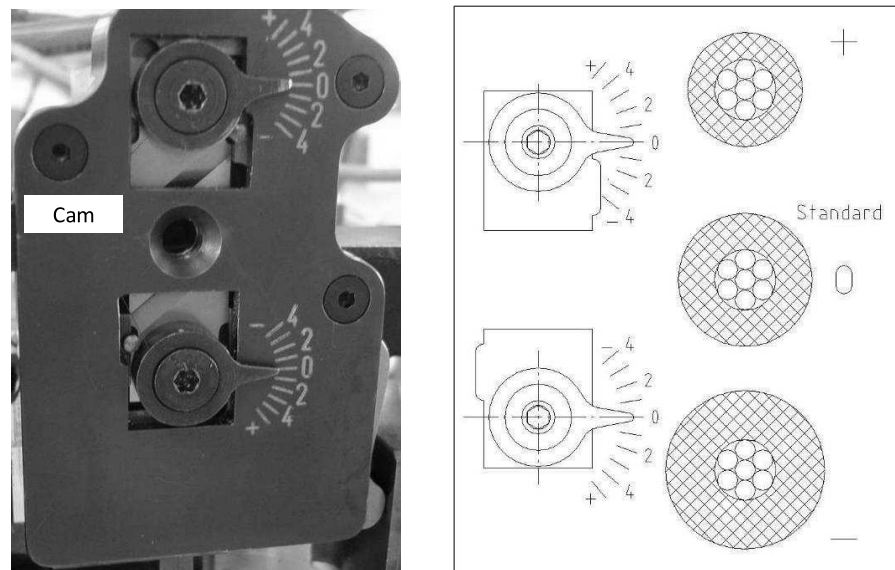

Fig. 5: Insulation stripping module

6 Maintenance



Warning!

Electrical shock caused by working on live components!

- Disconnect the mains plug and separate the machine from the pneumatic network.

6.1 Maintenance notes



Note:

- The manufacturer recommends that a customer service is performed on the machine every 400,000 cycles.
- Never clean the machine interior with compressed air.
- Do not use spray oil or spray grease.
- If possible, use silicone or PTFE oils (Teflon oil).
- Use lubricating greases suitable for roller bearings and sliding surfaces.
- The display and the touch screen are made of plastic and must not come into contact with hard objects. The touch-screen surface can be cleaned with a soft cloth without any solvents.

6.2 Daily maintenance

Emptying the stripped insulation scrap container

- Open the front panel.
- Withdraw and empty the stripped insulation scrap container.
- Reinsert the container.
- Close the front panel.

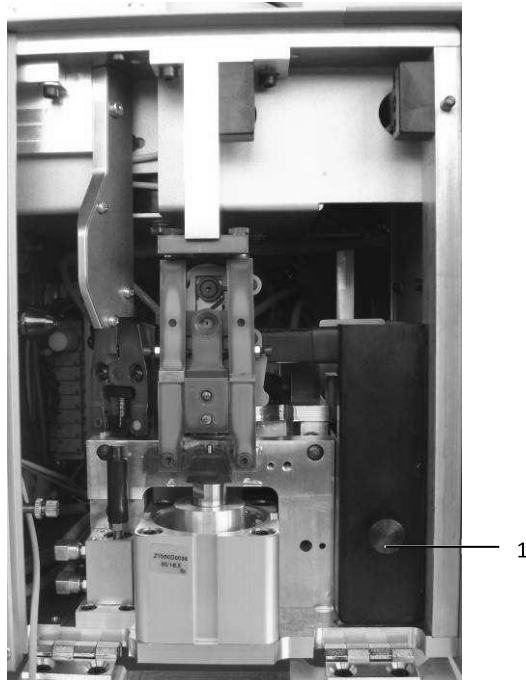

Fig. 6: Stripped insulation scrap container

Key

1 Stripped insulation scrap container

6.3 Weekly maintenance

Blowing clean the feed guide

- Remove the feed guide: unscrew the handle, turn the guide counter-clockwise and remove upwards.
- Remove the feeding material from the feed guide.
- Clean the guide carefully with compressed air.
- Replace the guide on the machine, turn clockwise to the limit stop and tighten the fastening handle.

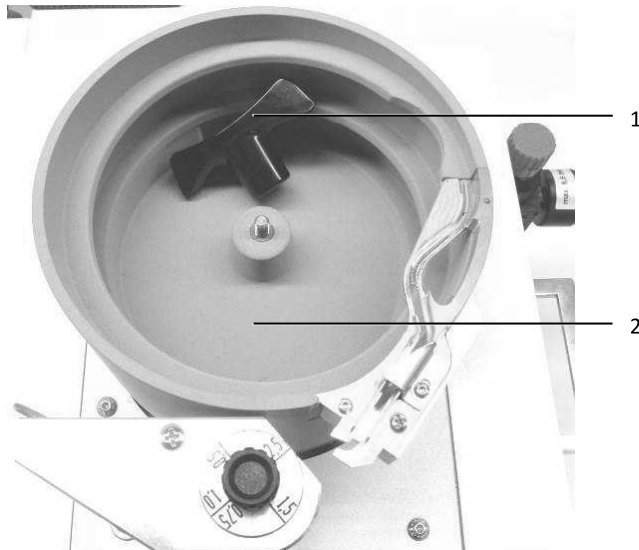

Fig. 7: Feed guide

Key

1 Handle

2 Feed guide

Cleaning the machine interior

- Open the front panel.
- Remove the stripped insulation scrap container.
- Clean the machine interior using a brush and a vacuum cleaner.

Attention!

Property damage!

Do not use compressed air to clean the machine interior.

Cleaning the stranded wire fixture

- Clean the stranded wire fixture using a brush and methylated spirits.

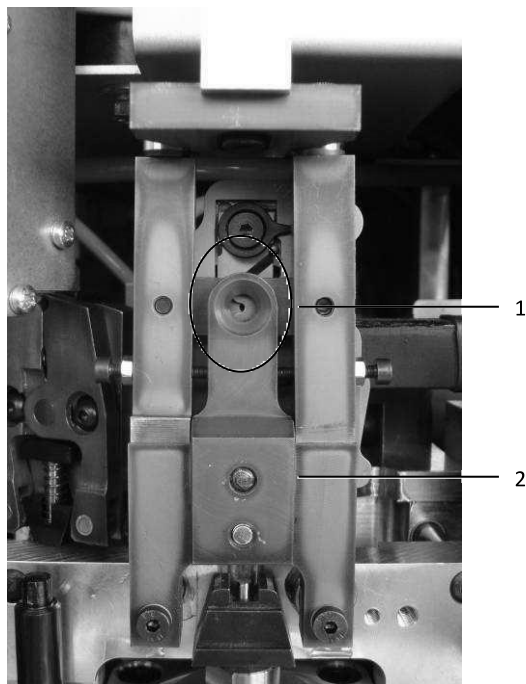

Fig. 8: Stranded wire fixture

Key

- 1 Cleaning area
- 2 Stranded wire fixture

Cleaning the holding pliers

- Open the front panel.
The holding pliers are located on the front panel.
- Clean the holding pliers using a brush.

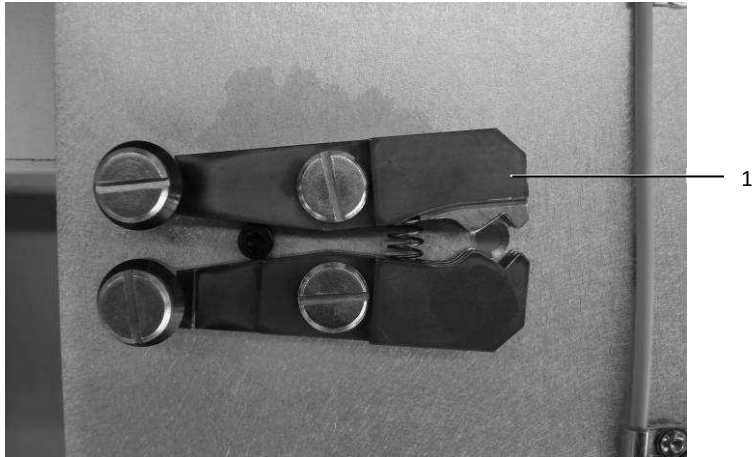

Fig. 9: Holding pliers

Key

1 Holding pliers

Cleaning the insulation stripping unit

- Swivel the tool unit to the right.
- Clean the entry hole in the insulation stripping unit carefully with a soft, suitable brush (e.g. pipe cleaner) and methylated spirits.
- Under no circumstances, lubricate the insulation stripping unit.

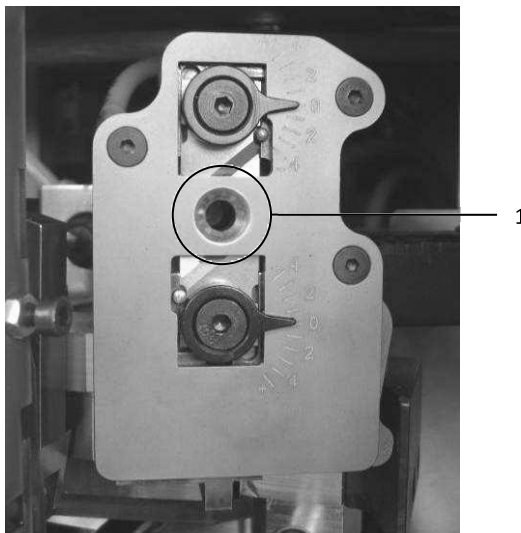

Fig. 10: Insulation stripping unit

Key

1 Cleaning area

Checking the insulation stripping blade

- Swivel the tool unit to the right.
- To visually check the blade for wear or damage, push the stripping carriage upwards.
- To reset the blade setting: Push the tool unit right to the limit stop.

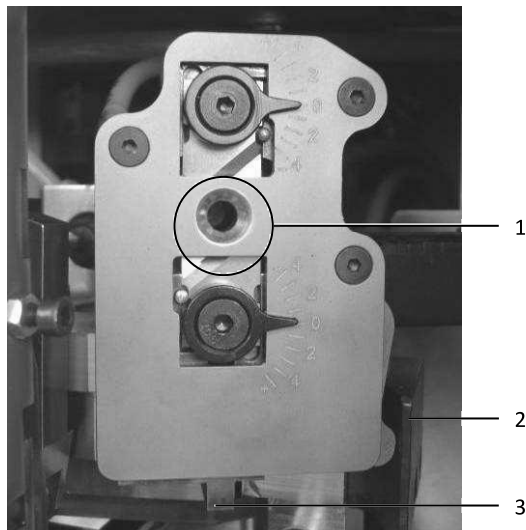

Fig. 11: Insulation stripping unit

Key

- 1 Control area
- 2 Limit stop
- 3 Stripping carriage

Checking the compressed area setting

To ensure correct functioning of the machine, the pressure set at the maintenance unit must lie in the range 5.0 to 5.5 bar.

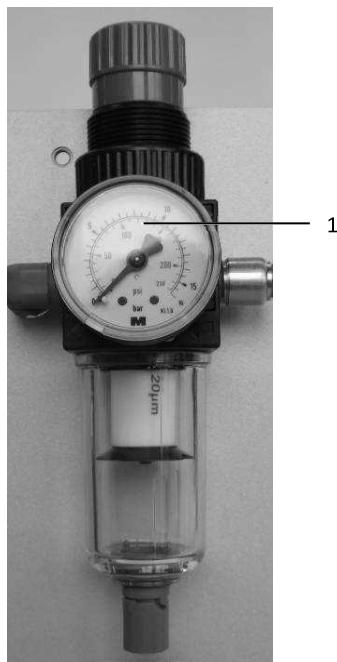

Fig. 12: Compressed-air maintenance unit

Key

- 1 Pressure setting

6.4 Monthly maintenance

Stranded wire fixture

- Check the stranded wire fixture castors for free movement.
- Lightly oil the castors pivot.
- Lightly oil the stranded wire fixture pivot.

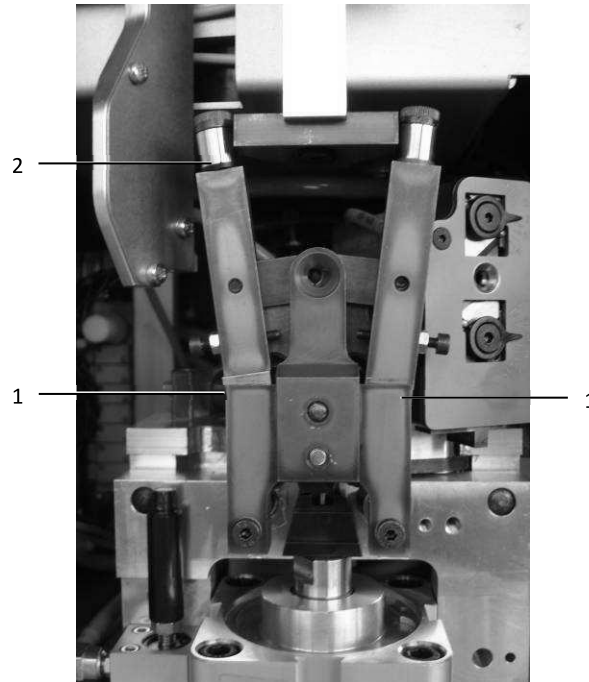

Fig. 13: Stranded wire fixture

Key

- 1 Stranded wire fixture pivot
- 2 Castor

Holding pliers

- Lightly oil the holding pliers at the pivot and the contact surface.

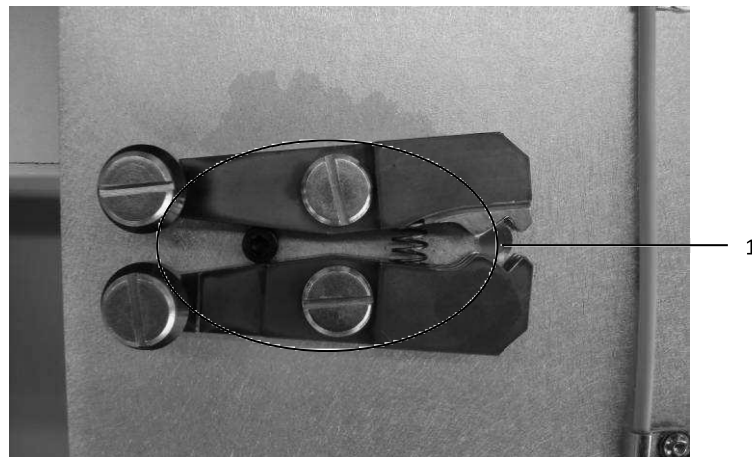

Fig. 14: Holding pliers

Key

- 1 Pivot and the contact surface

Ferrule holding unit and crimping tool

- Swivel the tool unit to the right.
- Loosen the right screw of the stranded wire fixture by half a turn.
- Hit the screw head lightly.
- Remove the right screw completely.
- Withdraw the stranded wire fixture at the front.
- Ensure that the distance ring remains on the shaft.
- Pull the tool unit forwards.
- Check the ferrule holding unit castors for free movement.

- Check the crimping tool castors for free movement.
- Lightly oil the castors pivot.
- Lightly oil the guide pin.
- Reinsert the stranded wire fixture. Ensure that the guide shaft sits in the hole of the stranded wire fixture.
- Tighten the right screw.

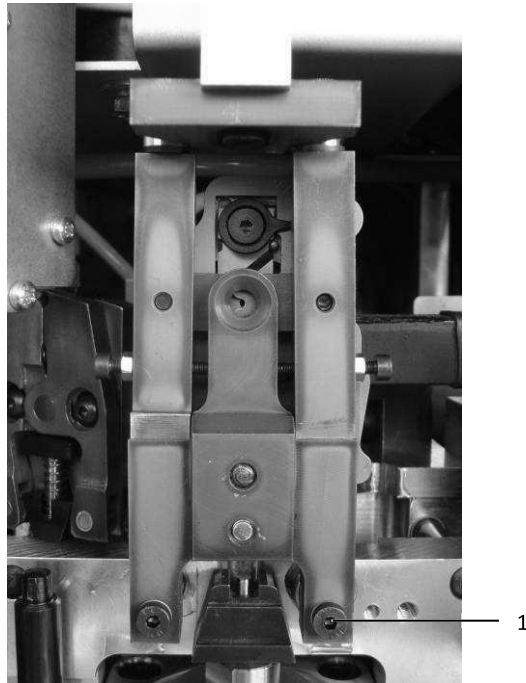

Fig. 15: Ferrule holding unit and crimping tool

Key

- 1 Right screw

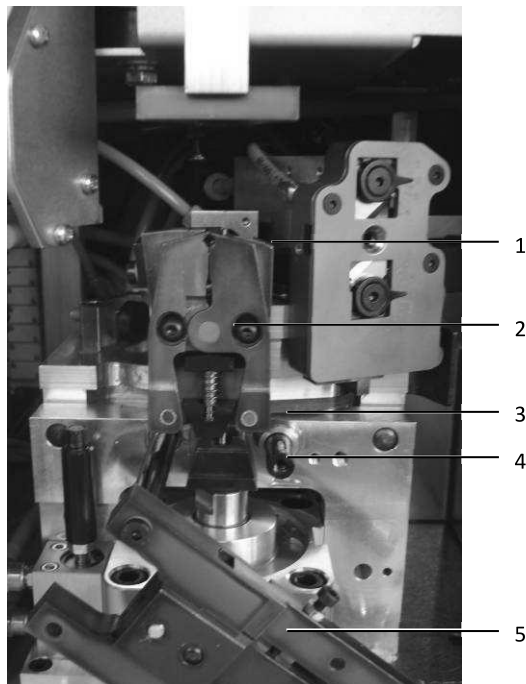

Fig. 16: Ferrule holding unit and crimping tool

- Key
- 1 Crimping tool
 - 2 Ferrule holding unit
 - 3 Distance ring
 - 4 Guide shaft
 - 5 Stranded wire fixture

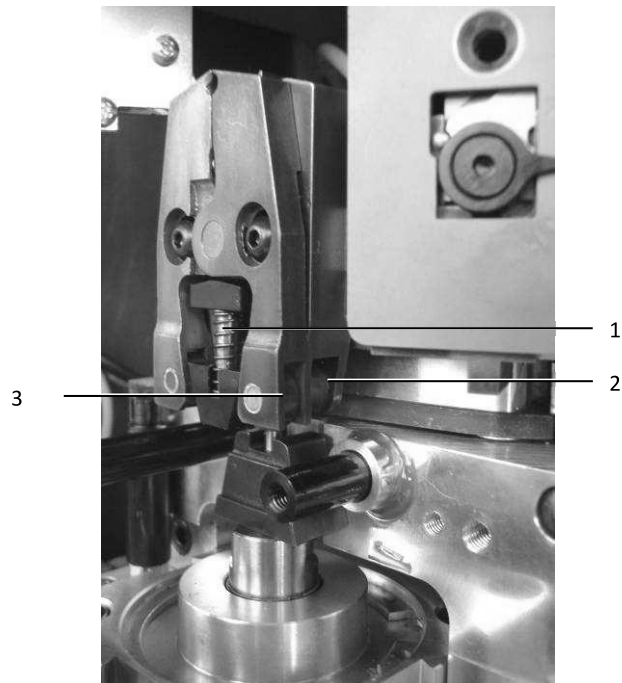

Fig. 17: Ferrule holding unit and crimping tool

- Key
- 1 Guide pin
 - 2 Crimping tool castor
 - 3 Ferrule holding unit castor

6.5 Quarterly maintenance

Lubricating the swivel carriage

- Pull the stranded wire fixture forwards.
- Lightly oil the contact surface using a brush.

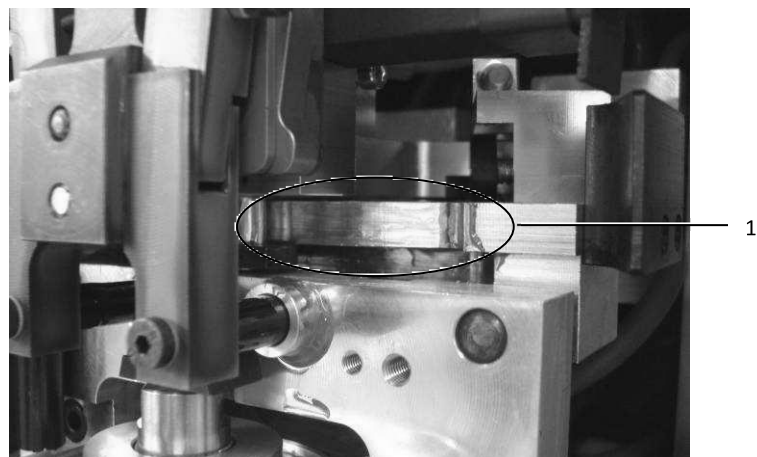

Fig. 18: Swivel carriage

- Key
- 1 Contact surface

6.6 When required

Compressed-air maintenance unit

- Drain the condensate water. To do this, press the drain plug upwards. If the container is soiled, it can be cleaned with water.
- To do this, close the compressed-air feed and unscrew the container.

Attention!

Property damage!

Clean the container only with water.

For cleaning, the filter element can be screwed off.

- Place the filter in a solvent (e.g. benzine or petroleum), flush well and allow to dry.

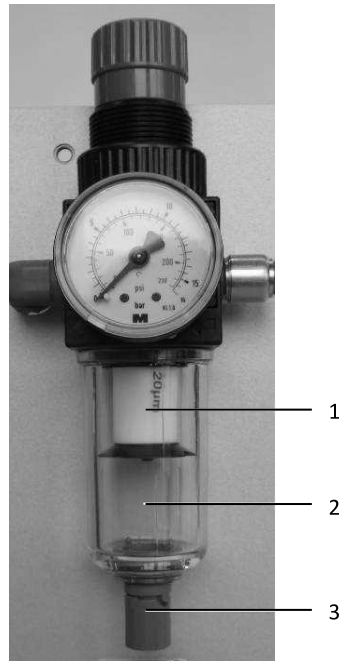

Fig. 19: Compressed-air maintenance unit

Key

- 1 Filter
- 2 Container
- 3 Drain plug

7 Troubleshooting

7.1 Machine does not start

The power supply is interrupted.

- Check the mains cable and the fuses.

7.2 No start for inserted wire

Start sensor (S1) is blocked with stripped insulation scrap.

- Remove the stripped insulation scrap.

Wire inserted incorrectly.

- Insert the wire as described in section 4.4 "Conductor insertion / conductor cutting".

7.3 The wire is only stripped.

Program 3 "Stripping" is selected

- Correct the setting.

7.4 Large number of rejects

Insulation stripping blade damaged or installed incorrectly.

- Repair or replace blade.

Stripped insulation scrap present between the tool unit and the right limit stop.

- Remove the stripped insulation scrap.

A second ferrule is present in the ferrule holding unit.

- Remove the ferrule.

The stripped insulation scrap container is full.

- Empty the stripped insulation scrap container.

7.5 Error messages

The error messages are shown in the display. Pressing the "Enter" key deletes the error message.

"no op.voltage +15"

- Operating voltage +15 V missing

"no op.voltage +24"

- Operating voltage +24 V missing

"inp.24V short c."

- Short-circuit at one of the inputs between +24 V and ground

"A1 / 2 -short c."

- Output 1 or 2 short-circuit

"A3 / 4 -short c."

- Output 3 or 4 short-circuit

"A5 / 6 -short c."

- Output 5 or 6 short-circuit

"A7 / 8 -short c."

- Output 7 or 8 short-circuit

"A9 / 10 -short c."

- Output 9 or 10 short-circuit

"A11 / 12 -short c."

- Output 11 or 10 short-circuit

"VC-err.amplifier"

- Vibrating conveyor guide activation: End level error

"VC-alert tempr."

- Vibrating conveyor guide activation: Warning, temperature in the limit range

"VC-error tempr."

- Vibrating conveyor guide activation: Shutdown, temperature too high

"VC-RS485 Tim.Out"

- Vibrating conveyor guide activation: Timeout, check the connection cable

"VC-error 230V"

- Check the mains voltage
- Vibrating conveyor guide activation: 230V missing

"VC-error 115V"

- Check the mains voltage
- Vibrating conveyor guide activation: 115V missing

"VC-reserve"

- Vibrating conveyor guide activation: Reserve

"VC-not ready"

- Vibrating conveyor guide activation not ready / error pending

"error frontpl. K1"

- S6 switch defective
- Error when closing the front panel
- Press the "Enter key" for 4 seconds

"error frontpl. K2"

- S6 switch defective
- Error when closing the front panel
- Press the "Enter key" for 4 seconds

"frontplate open"

- Close the front panel

"feeding error"

- VC infeed fault
- Checking the vibrating conveyor

"S1-start = 0"

- Start sensor S1 = 0 is not actuated

"S1-start = 1"

- Start sensor S1 = 1 is not free

"S3-stripposit.=0"

- Check S3 and Y3

"S3-stripposit.= 1"

- Check S3 and Y3

"S4-Toolslide front = 0"

- Check S4 and Y1

"S4-Toolslide front = 1"

- Check S4 and Y1.

"S5-Toolslide back = 0"

- Check S5 and Y1.

"S5-Toolslide back = 1"

- Check S5 and Y1.

"LS10-fer.missing"

- Ferrule missing, check S10

"LS10-fer. present.=1"

- Remove ferrule, check S10

"ex.start n. ready"

- Ext. Start not ready

"error data vers"

- Incorrect data version for USB data transfer with PC

"error USB-cable"

- USB cable not inserted

"error time out"

- Incorrect data version
- Interruption during the data transfer

8 Pneumatic connection diagram

EN

8 Pneumatic connection diagram

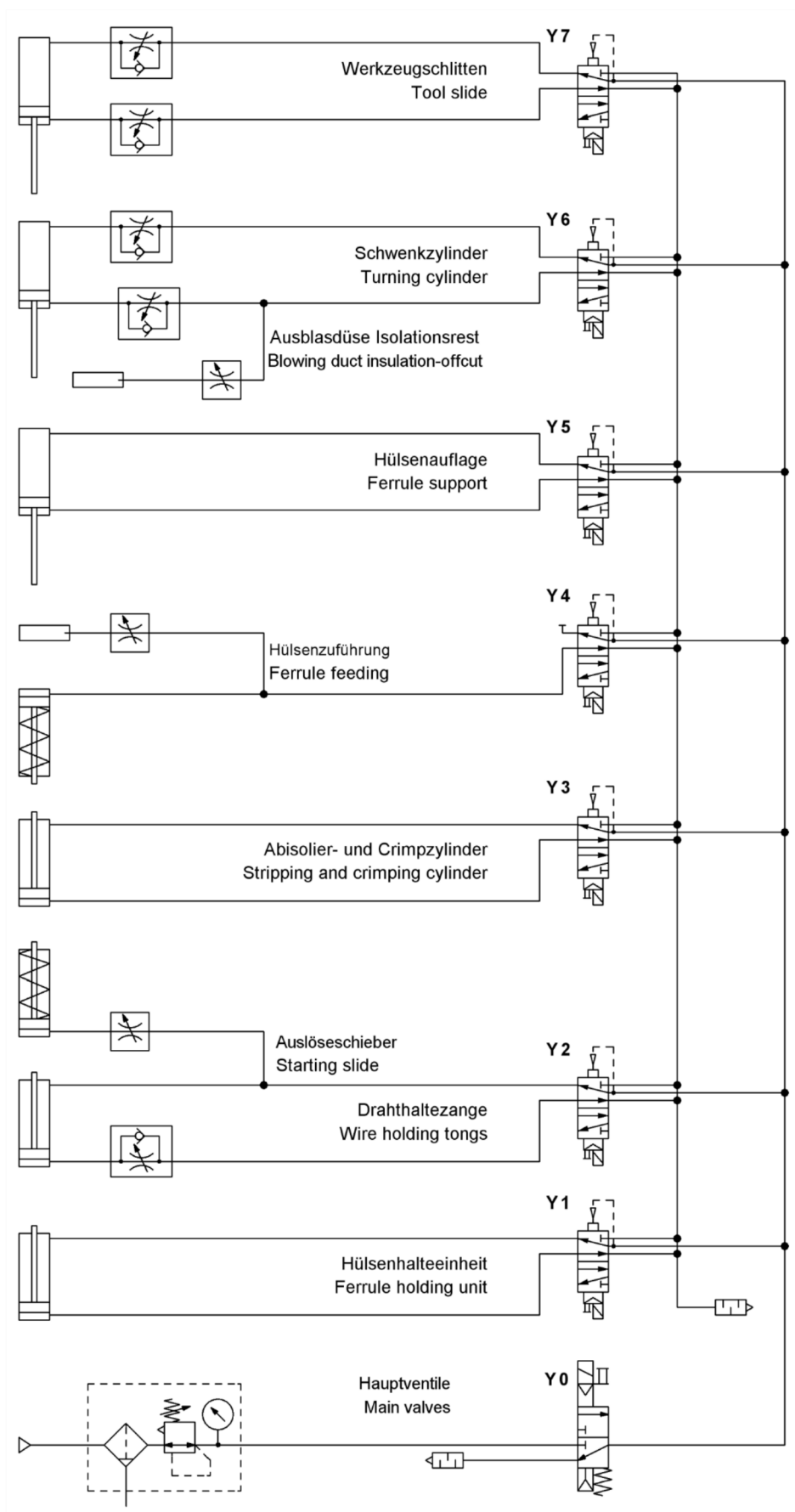

9 Electrical connection diagram

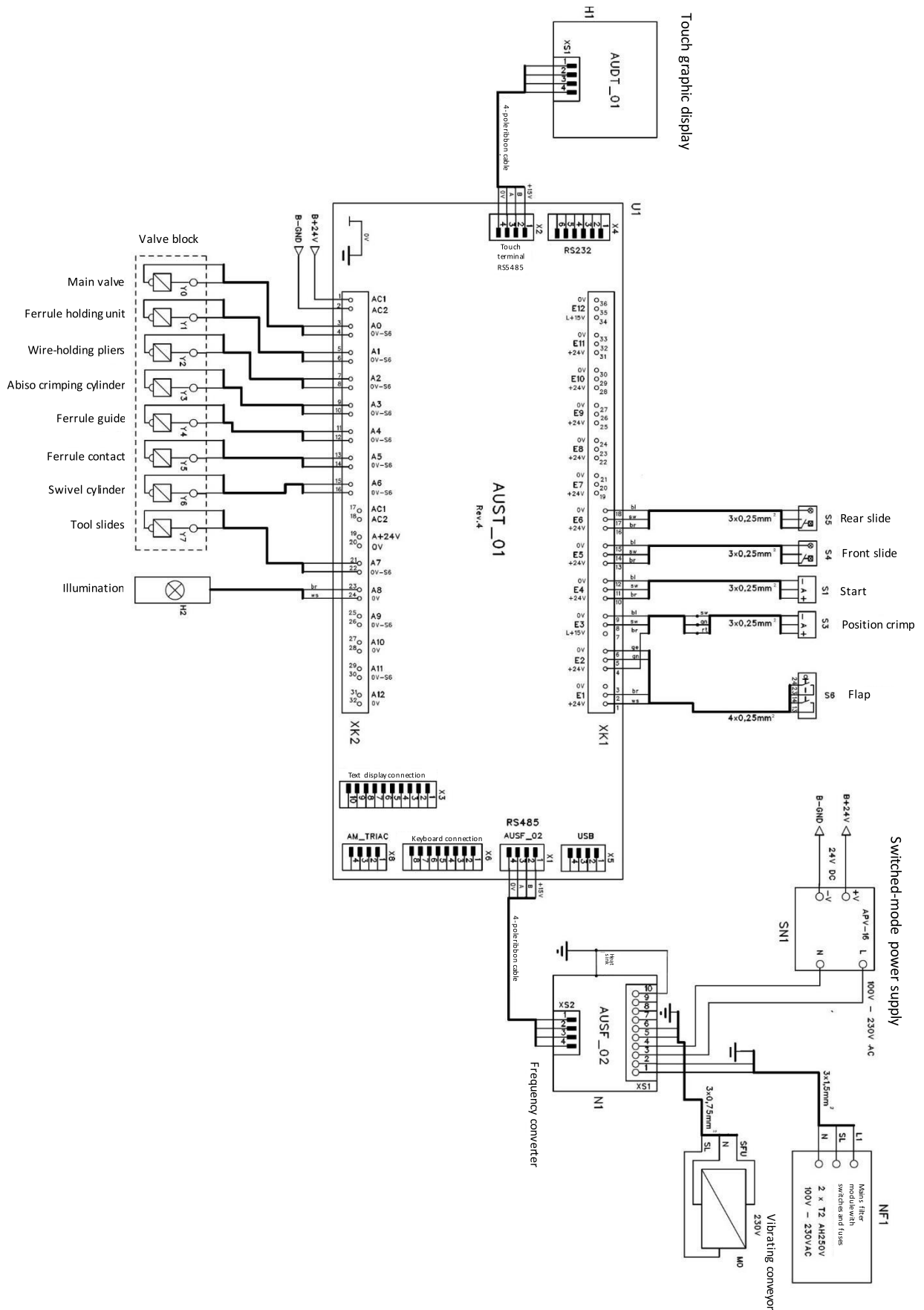

10 Spare parts

Designation	Model no. AS
Insulation stripping blade kit, titanium	4050466
Wire end ferrules 0.5 mm ² , 8 mm long	4050730
Wire end ferrules 0.75 mm ² , 8 mm long	4050731
Wire end ferrules 1.0 mm ² , 8 mm long	4050732
Wire end ferrules 1.5 mm ² , 8 mm long	4050733
Wire end ferrules 2.5 mm ² , 8 mm long	4050734
Wire end ferrules 0.5 mm ² , 8 mm long AWG	4050742
Wire end ferrules 0.75 mm ² , 8 mm long AWG	4050743
Wire end ferrules 1.0 mm ² , 8 mm long AWG	4050744
Wire end ferrules 1.5 mm ² , 8 mm long AWG	4050745
Vibrating conveyor pot 0.5 – 1.0 mm ²	4050467
Vibrating conveyor pot 1.5 – 2.5 mm ²	4050468



Note:

- In the event of an order, specify the serial number of the machine.

11 Disposal

- Switch off the machine at the mains switch.
- Disconnect the machine from the power grid.



Machine disposal as house refuse is not permitted. The machine should be disposed of environmentally conform and properly. The local waste disposal regulations and the legal requirements for disposal must be observed.

Rittal – The System.

Faster – better – everywhere.

- Enclosures
- Power Distribution
- Climate Control
- IT Infrastructure
- Software & Services

You can find the contact details of all Rittal companies throughout the world here.



www.rittal.com/contact

RITTAL GmbH & Co. KG
Auf dem Stuetzelberg · 35745 Herborn · Germany
Phone +49 2772 505-0
E-mail: info@rittal.de · www.rittal.com

07.2021 / D-0100-00000027-01-EN

ENCLOSURES

POWER DISTRIBUTION

CLIMATE CONTROL

IT INFRASTRUCTURE

SOFTWARE & SERVICES

FRIEDHELM LOH GROUP

