

AS cutting machine C 8



EN Operating manual

Before putting the machine into operation, read the operating manual!
Keep manual for future use.

Fabrication number

Art.No. 4050.450



RITTAL GmbH & Co. KG
Auf dem Stützelberg
POB 1662
D-35726 Herborn
Germany



Phone + 49(0)2772 505-0
Fax + 49(0)2772 505-2319
info@rittal.de
www.rittal.de

March 2016, Version 2.0

When contacting the manufacturer for any information,
please have the machine type and the fabrication number available.
(See type plate on the machine)

© 2016 Rittal GmbH & Co.KG, All rights reserved.

Table of contents

1	GENERAL	1
1.1	INTRODUCTION	1
1.2	TARGET GROUP	1
1.3	RESERVATION OF THE RIGHT OF MODIFICATION AND COPYRIGHT	1
1.4	TRAINING AND INSTRUCTION	2
1.5	UNAUTHORIZED MODIFICATION AND SPARE PARTS	2
1.6	TRANSPORT	2
2	SAFETY	3
2.1	INTENDED USE	3
2.2	PROHIBITED USE	3
2.3	DANGER OF THE MACHINE	4
2.4	USE RISKS	4
2.5	SOURCE OF DANGER	4
2.6	SAFETY INSTALLATIONS	4
2.7	SIGNS AND SYMBOLS	5
	2.7.1 WARNING SIGNS	5
	2.7.2 MANDATORY SIGNS	6
	2.7.3 INFORMATION SIGNS	6
2.8	REMAINING RISKS	7
2.9	SECURITY MEASURES AT THE INSTALLATION LOCATION	7
2.10	NOTES FOR THE OPERATOR	8
2.11	NOISE HAZARD	8
3	PRODUCT DESCRIPTION	9
3.1	TECHNICAL DATA	9
3.2	GENERAL VIEW OF THE MACHINE	10
4	INSTRUCTION MANUAL	11
4.1	PUTTING INTO OPERATION	11
4.2	STARTING THE MACHINE	11
4.3	ADJUST THE CONTRAST	11
4.4	PUT IN THE WIRE	11
4.5	STANDARD MENU	12
4.6	EXTENDED MENU	13
5	MAINTENANCE	15
5.1	CLEANING	15
5.2	BLADE REPLACEMENT	15
5.3	CHANGE THE TOOTHED BELT	16
6	TROUBLESHOOTING	19
6.1	THE MACHINE DOES NOT START	19
6.2	INCREASING REFUSE	19
6.3	ERROR MESSAGES	19
7	ELECTRICAL DIAGRAM	21
8	SPARE PARTS LIST	23
9	DISPOSAL	25

1 General

1.1 Introduction

This instruction manual contains: important notes, how to use the machine safely and appropriately. The operating manual helps you to avoid dangers, as well as reduce repair costs and down time.

By following the operation manual, you increase the product reliability and life time of the machine.

This operation manual must be available to persons operating the machine. Persons, working with the machine, must read and follow the operation manual.

This manual includes:

- ◆ Putting the machine into operation
- ◆ Operation of the machine
- ◆ Troubleshooting
- ◆ Maintenance (maintenance / service)
- ◆ Transportation

To ensure safety, this machine is only intended for use as described in this manual.

The Rittal GmbH & Co.KG GmbH, Auf dem Stützelberg, D-35745 Herborn is following called manufacturer.

1.2 Target group

This operating manual is designed for the normal worker.

1.3 Reservation of the right of modification and copyright

The copyright, as well as all rights in the event of grant or utility model registration in this operating manual remains by the manufacturer.

The listed rules, guidelines, engineer standards and so on in this operating manual are to conform to the information during the elaboration.

Regulations and drawings of technical parts may neither completely nor partly be duplicated, spread, utilized or informed to others for other unauthorized purposes (e.g. competition).

If the operator desires the regulations and drawings of technical parts outlined above, this requires expressed, written approval from the management of the manufacturer.

The manufacturer reserves the right to technical changes and improvements at any time. This applies to all data, details, notes and illustrations of this operation manual. A claim to change and improvement of already delivered tools is impossible.

This operating manual was created with reasonable care.

1.4 Training and instruction

- ◆ Only trained and qualified personnel are allowed to handle this machine.
- ◆ The responsibilities of the personnel operating, changing tools and maintaining this machine must be well defined.
- ◆ Only the manufacturer or authorized service workshops are entitled to repair these products.

1.5 Unauthorized modification and spare parts

- ◆ Modifications, mounting and reconstructions at the control can lead to unpredictable dangers.
- ◆ Any kind of modification and manipulation at the tools are forbidden. If the operator makes any modifications or manipulations of this kind, machine safety is no longer guaranteed. The manufacturer takes no liability for defects and consequential damages which occur due to the aforementioned measures.
- ◆ Use only original spare parts and authorized accessories from the manufacturer. The use of other parts excludes liability for damages every description (consequential damages, too).

1.6 Transport

For the transportation always use the complete original packing.



For service and repair work, the machine must be sent in with all accessories.

2 Safety

2.1 Intended use

The machine is a cutting machine. This machine was only designed for cutting of rounds cables. For this reason the machine was constructed for only this exact purpose.

The intended use includes compliance to:

- ◆ All notes in the operating manual
- ◆ Documentation of the supplier products.
- ◆ All notes on maintenance

Any other use is not permitted.

The description in **paragraph 3.1 “Technical data”**, are to keep and follow as well as in the original documentation possibly the supplier products.

An abnormal use of the machine is not known by manufacturer.

For originated defects, because of an uncorrected purpose of use or by a not intended use the manufacturer takes no responsibility.

2.2 Prohibited use

- ◆ Removing information signs or warning signs.
- ◆ Opening the machine during operation.
- ◆ Using the machine when there are obvious visible defects or damages.
- ◆ Do not insert any kind of object to the feeding funnel, which is not designed for this use.

2.3 Danger of the machine

The findings of the hazard analysis are that the machine is conforming to guidelines and can classify as safe.

As with any machine, risks still remain and they cannot be eliminated by construction.

See 2.8 *Remaining risks*.

2.4 Use risks

The user is only allowed to eliminate disorders where the cover must not remove.

Before you change the tools or spare parts, you have to unplug and disconnect the machine from the power supply system.

2.5 Source of danger

Before performing maintenance and cleaning on the machine, the machine must be switched off from the power supply system (e.g. Disconnect from the power supply, switch off the fuse)



Never remove the safety installations or put out of control by changes of the machine.

2.6 Safety installations

The safety installations are designed to protect the worker.

The operator undertakes to do yearly a check of the safety installations.

Cover Should the removal of the cover be necessary, take care that the earth wire is connected after re-closing the machine.
The removal of the cover is only to be performed by skilled workers or instructed personnel.

Switching power supply (SELV) The switching power supply protects from dangerous voltages.
It is not possible for more than 60 V-AC or 110 V-DC to go through the machine.

It is not allowed in any way to remove or make changes to the machine that interferes with the safety installations.

2.7 Signs and Symbols

The operating manual uses the following important signs and names for safety instructions.

2.7.1 Warning signs



Signal word!

This warning sign describes a possible danger.

The non-observance of these signs can cause injuries or property damages.

This sign is often used in combination with mandatory signs.



WARNING! Danger by electrical voltage!



CAUTION!

Warning for cutting injuries of the hand.

2.7.2 Mandatory signs



Consider the operating manual!
Before putting the machine into operation read the operating manual carefully.



This sign marks important operation instruction and application instructions.
The non-observance of the notes can produce damages of the tool and other material values from the operator.



Unplug main switch



Use the machine only in dry conditions.

2.7.3 Information signs

Earth conductor

This label is placed at the earthing screw.



The protective earthing is a method, which safeguards in a fault against dangerous voltage and electric shock.

The method protective earthing is performed by an earth conductor.

The connection is created by a rubber connector with earth conductor contact.

The earth conductor "PE" (green/yellow insulation only in Germany) is used for this safety installation.

2.8 Remaining risks

With observance of all safety notes and warning information, remaining risks are still possible with operation of the tool.

This machine is state of the art and accredits safety-related rules.
However, dangers can occur with use of the tool.

Errors which could influence the safety should be eliminated immediately, if necessary contact the manufacturer with the fabrication number.



WARNING!

Electric shock risk when working with conducting parts.

⇒ *Work on electric parts should only be performed by skilled personnel.*

2.9 Security measures at the installation location

The machine must be installed securely on a table.

→ *A fallen machine represents a great risk of injury.*



Internal instructions and controls should ensure that the work place and the environment are clean and clear.

2.10 Notes for the operator



- ⇒ **The duty of the operator is to write a directive.**
 - ⇒ **The operator is to do yearly a check of the safety installations.**
 - ⇒ **Use only original fuses with declared amperage.**
-

- ◆ Knowledge of the local regulations relating to safety and accident prevention.
- ◆ All notes on the tool have to be kept in readable condition; if necessary you have to exchange them.
- ◆ Inform the manufacturer immediately, if the machine and the application becomes unsafe.
- ◆ Change machine parts immediately, if they are not in good order and condition.
- ◆ Before you put the machine into operation the machine must be in a safe condition.

2.11 Noise hazard

The equivalent continuous weighted sound pressure level of the cutting machine enclosure ≤ 70 dB(A).

No ear protection is necessary for the operation of this machine.

3 Product description

3.1 Technical data

Designation	Unit
Drive	Electric motor
Voltage	100 - 240 VAC
Frequency	50 / 60 Hz
Power consumption	260 VA
Fuse (filter-module)	2x T4AH250V
Multicore conductor	0,08-10 mm ²
Single core conductor	0,08 – 2,5 mm ²
Maximal outside diameter	8 mm
Length	1 – 999999 mm
IP-Code	IP 20
Rate of feed	0 – 1,5 m/s
Continous sound level	≤70 dB(A)
Dimensions (wxdxh)	385 x 360 x 470 mm
Colour	RAL 9003
Weight	20 kg
Interface	USB-interface

Operating environment	Unit
Transport temperature	-25°C to +55°C
Enviromental temperature	-5°C to 40°C
Operating temperature	+10°C to 45°C
Max. operating height	2000m absolute altitude
Relative humidity	50% to 40°C (no condensation)
	90% to 20°C (no condensation)
Contamination level	2
Pressure safety installation	85% to 110%

3.2 General view of the machine

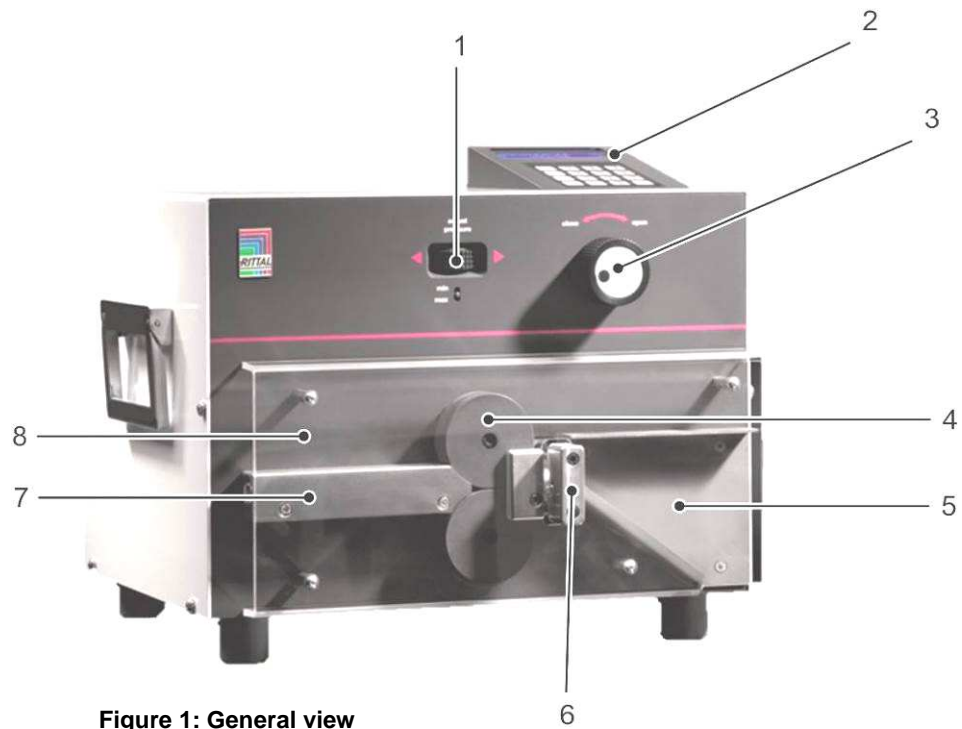
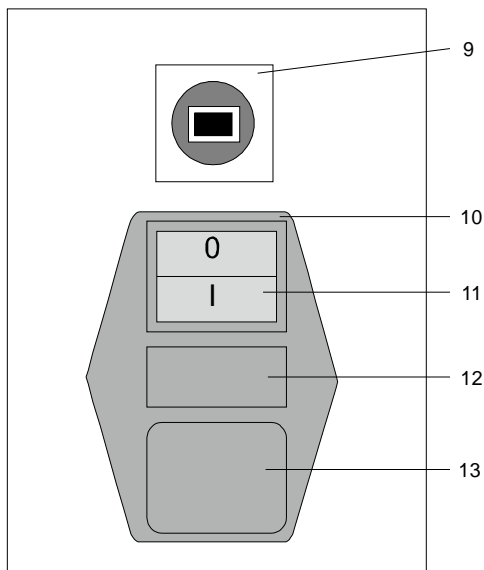

Figure 1: General view



- 1 Contact pressure of the rollers
- 2 Control unit
- 3 Position of the rollers
- 4 Rollers
- 5 Chute
- 6 Blades
- 7 Wire feeding
- 8 Plastic cover
- 9 USB-interface
- 10 Filtermodul
- 11 Power switch
- 12 Fuse
- 13 Mains plug

Picture 1: Back view

4 Instruction manual

4.1 Putting into operation



⚠ CAUTION!

The electrical data on the type plate must conform with the electrical power supply.

⇒ Connect the main cable between the machine and the electrical power supply.



NOTICE!

A driver for the USB interface is arranged on a mini disk.

The software PCCUT for the machine is on the disk.

4.2 Starting the machine



Switch on the main switch on the power switch.

The standard menu is opened and the sub-menu 1 program with the program number appears in the display.

4.3 Adjust the contrast

1. Switch on the machine
2. **SHIFT** + **7 / F7** → Display gets brighter.
3. **SHIFT** + **8 / F8** → Display gets darker.

4.4 Put in the wire

1. Position of the rollers: 
2. Insert the wire through the wire feeding until it appears on the right side of the blades.
3. Position of the rollers: 

4.5 Standard menu

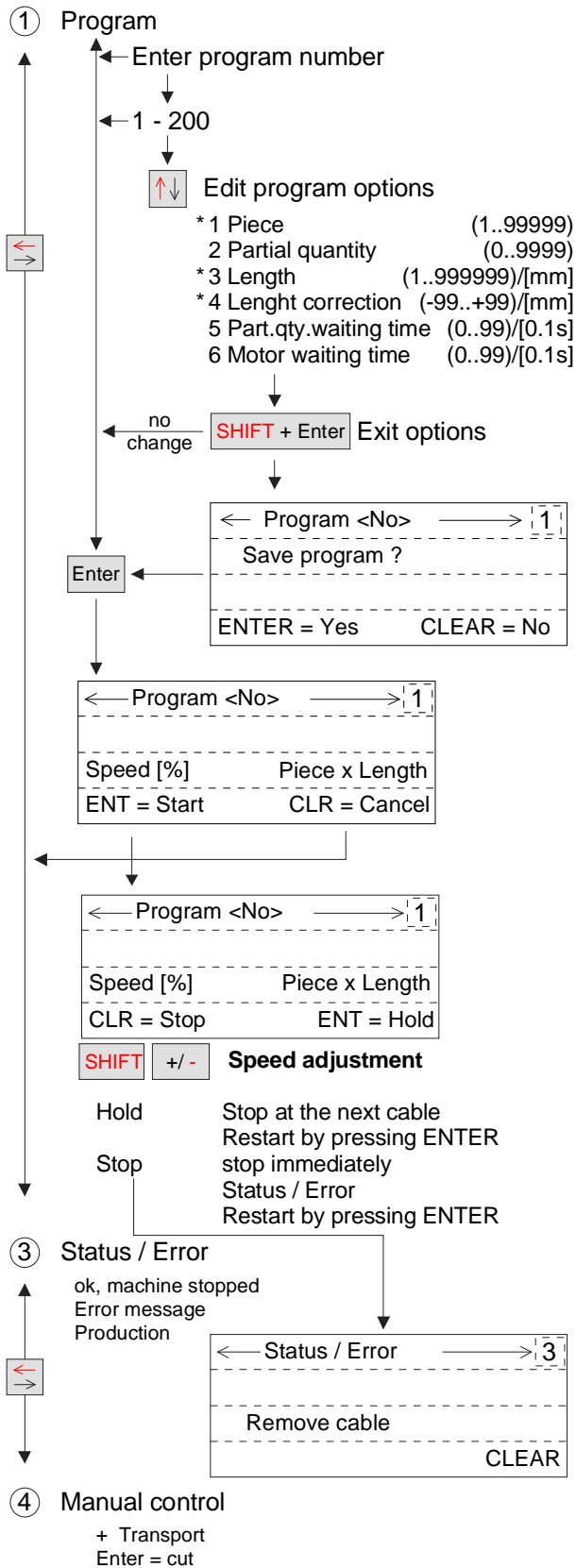

F1 = help

*short program

4.6 Extended menu

Mains switch + 

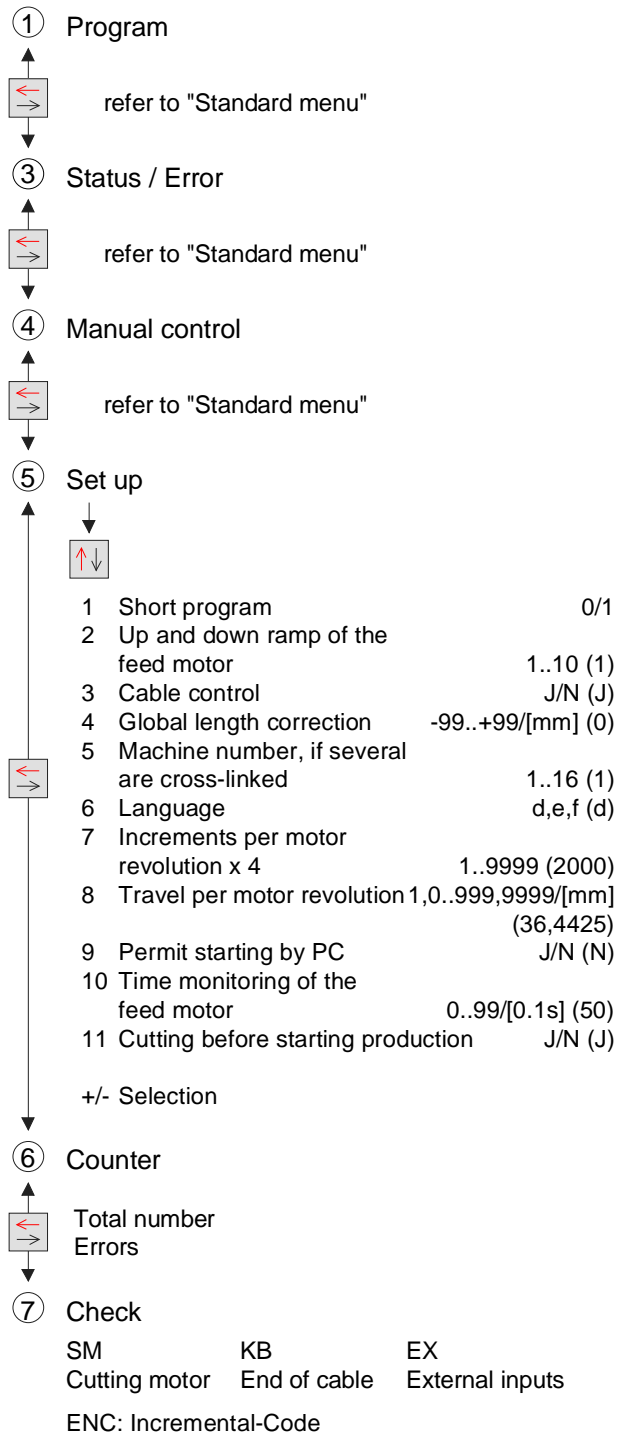

F1 = help

5 Maintenance



NOTE!

Before maintenance, the machine must be disconnected from the power supply.

⇒ *Otherwise a risk of injury threatening!*

5.1 Cleaning

- Clean the surface of the rollers with spirit.
-
- Blow out the cutting area with compressed air.

5.2 Blade replacement



CAUTION!

Blades are sharp.

It consist the danger of cutting damages of the fingers.

⇒ *Do not touch the blade.*

1. Switch off the machine and pull out the main plug.
2. Screw off the plastic cover.
3. Screw off the chute.
4. Release the fixing screws of the blades.
→ Use a short hexagon socket key
5. Replace blades.

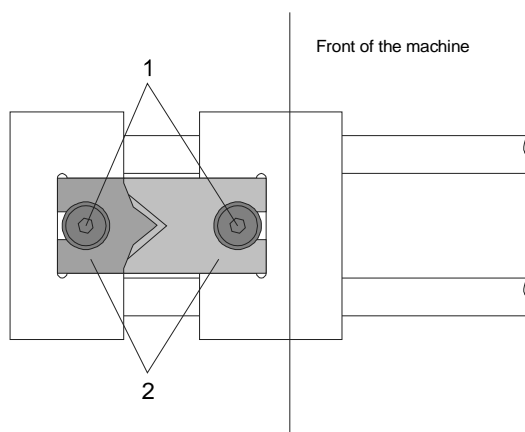

1	Fixing screws
2	Blades

Picture 2: Blades

5.3 Change the toothed belt

Tools needed:

Retaining ring pliers for outer rings resp. shafts

1. Remove the tooth belt (drive motor).

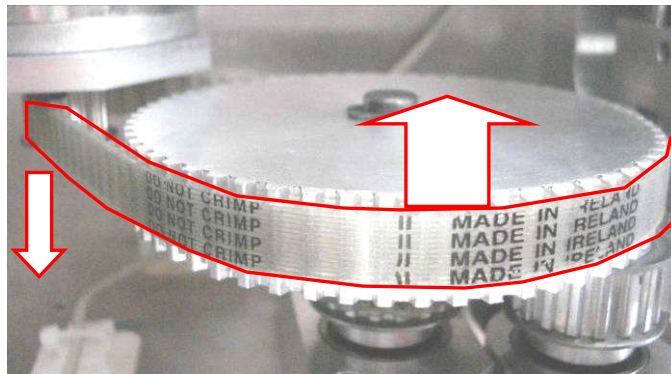

2. Remove the locking ring.



NOTICE!

The fitting key (1) can get lost.

⇒ *Carefully dismount the gear-wheel.*

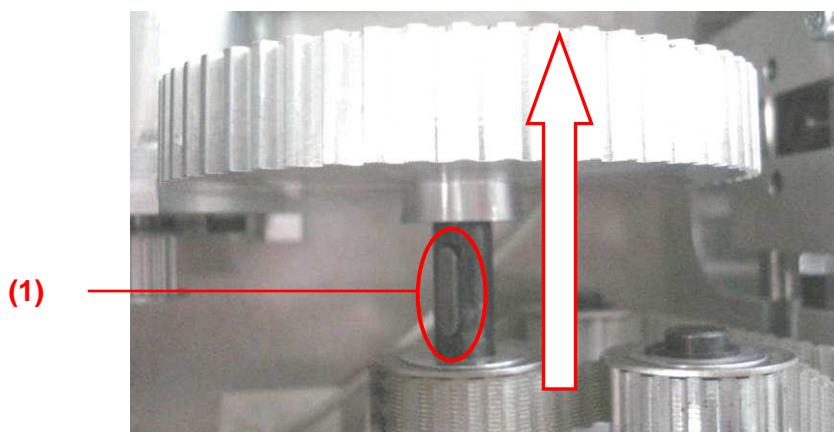

3. Close rollers.



4. Remove the double tooth belt (cut motor).

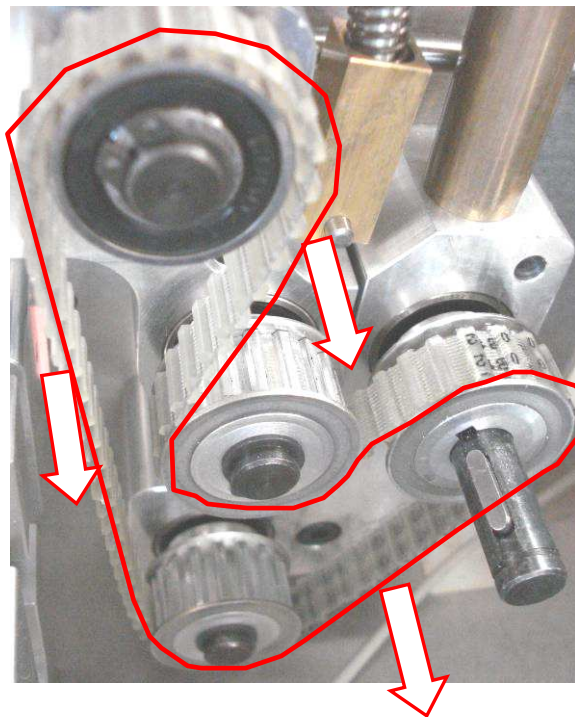

6 Troubleshooting

6.1 The machine does not start

The electrical supply is disturbed

- ⇒ Check the main cable and the fuses

6.2 Increasing refuse

The blades are damaged or incorrectly installed.

- ⇒ Correct or change the blades.

6.3 Error messages

The error messages are shown on the display. After the repair of failures and by pressing the “clear button” the error message is deleted.

The current production can be continued. The production of the last piece will be repeated.

Timeout position

- Check the feed motor: Sub-menu 4 manual control
- Check the incremental encoder: Sub-menu 7 check, rotate the feed motor by hand.

No cable

- End of cable reached. Insert new cable.

cut photo barrier

- Check the light barrier of the cutting motor for contamination.

Timeout cut

- Check the light barrier of the cutting motor: Sub-menu 7 check.

Remove cable

- Emergency stop: Remove the last produced cable.

7 Electrical diagram

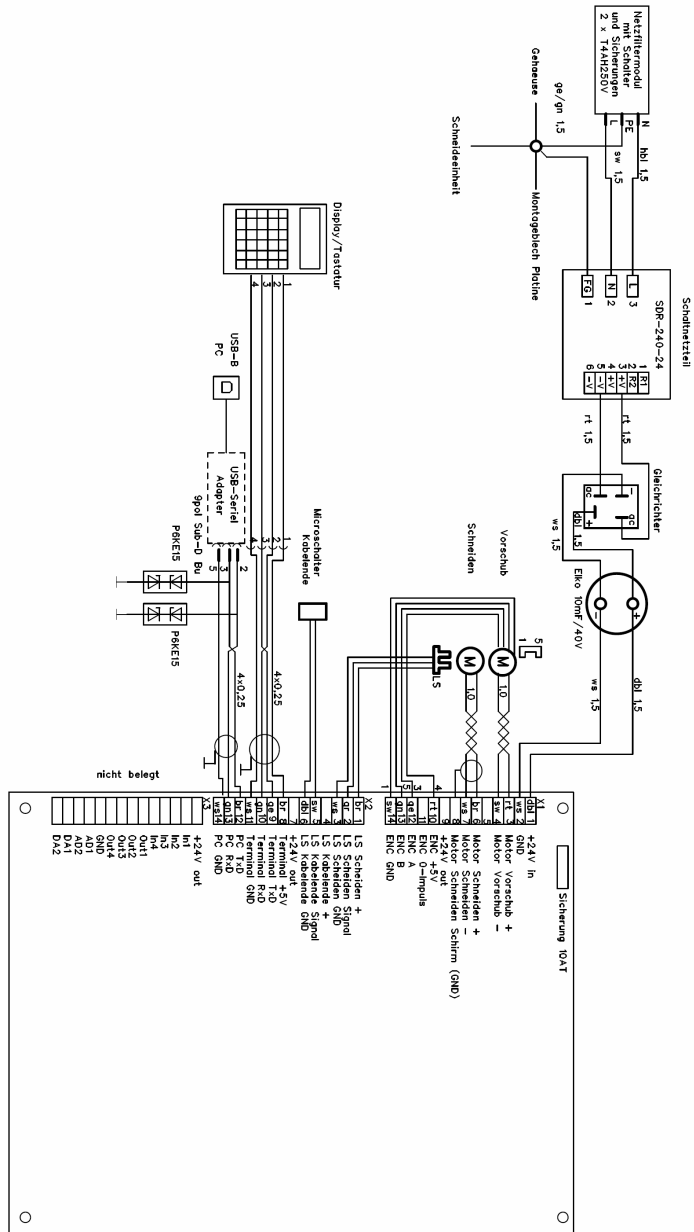
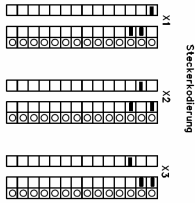

Bearb.	Datum	Name	CutFix	Type:	CutFix	Rev
Gez.	6.1999	FH	Anschlussplan	Z.Nr.:		2
Änder.	17.02.16	Koch		F.Nr.:		
Datei	cut_a7			Plat. Nr.:		
				Schaltplan	Anz.Bl.:	1

8 Spare parts list

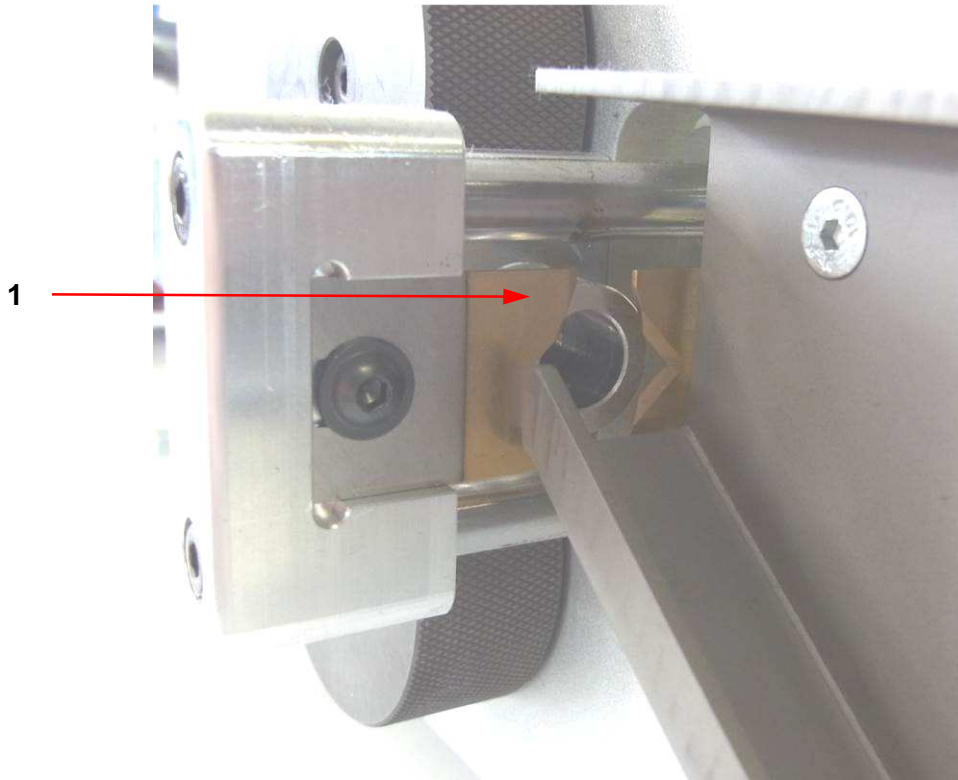

No.	Designation	No.
1	AS replacem. for V-stripping-knife titan (2 pieces)	4050465

9 Disposal

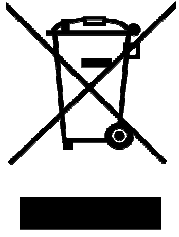

It is not allowed to dispose the machine in the domestic waste.
The disposal of the machine should be done professional and environmental manner.

