

Rittal – The System.

Faster – better – everywhere.

DET-AC III Master Active Extinguishing System



DK 7338.121

Mounting, installation and operating instructions

ENCLOSURES

POWER DISTRIBUTION

CLIMATE CONTROL

IT INFRASTRUCTURE

SOFTWARE & SERVICES

FRIEDHELM LOH GROUP



IMPORTANT! Read this document before starting any work!

This document is a mandatory part of the system and should therefore always be stored freely accessible and for further usage.

Original document

Rittal GmbH & Co. KG

Postfach 1662

D-35726 Herborn

Germany

Phone: +49(0)2772 505-0

Fax: +49(0)2772 505-2319

Internet: <http://www.rittal.com>

E-Mail: info@rittal.com

Document identification:

Document name	---
Language	en_US
Document no.	100046739
DOC ID	100153985
Approval / modification no.	ES22-095
Part no.	916005
Revision	07
Version	01
Edition	11-2022

Table of contents

1	Legal note	8
2	General	10
2.1	Overview.....	10
2.2	Abstract.....	10
2.3	Scope of delivery.....	11
2.4	Limitations of liability.....	12
3	Safety	14
3.1	Safety and warning notices.....	14
3.2	Warnings in instructions.....	14
3.3	Intended use.....	15
3.4	Safe operation.....	16
3.5	General dangers.....	16
3.5.1	General dangers associated with fire extinguishing systems.....	17
3.5.2	Dangers when activating the system.....	17
3.6	Qualification of personnel.....	18
3.7	Instruction.....	20
3.8	Personal protective equipment.....	20
3.9	Operator's responsibility.....	21
3.9.1	Owner.....	21
3.9.2	Owner's obligations.....	21
3.10	Responsibility of the Authorized Distributor.....	22
3.10.1	Authorized Distributor.....	22
3.10.2	Obligations of the Authorized Distributor.....	22
3.11	Signage.....	23
3.12	Environmental protection.....	23
3.13	Behavior in the event of a fire.....	24
3.13.1	Preventive steps.....	24
3.13.2	Steps in the event of a fire.....	24
4	Transport and packaging	25
4.1	Transport inspection.....	25
4.2	Transport.....	26

4.3	Packaging.....	27
5	Structure, function and connections.....	28
5.1	Structure.....	28
5.2	Function.....	28
5.3	Connections.....	30
5.3.1	Relay outputs.....	31
5.3.2	Door contact switch.....	31
5.3.3	Interfaces to the Monitoring System.....	32
5.3.4	Connection of external alarm device.....	33
5.3.5	Connection of external fill level monitoring and triggering of external tank.....	33
5.3.6	Manual call point connection.....	33
5.3.7	Power supply.....	34
5.3.8	USB port.....	34
5.3.9	Connection for networking.....	34
6	Assembly and installation.....	35
6.1	Operating conditions and installation requirements.....	35
6.2	Installation and commissioning.....	36
6.2.1	Installation instructions.....	37
6.2.2	Installation steps and functional test.....	38
6.2.3	Temperature indicator.....	42
6.2.4	Language setting for display and operation.....	42
6.2.5	Suction pipe installation instructions.....	43
6.2.6	Instructions for the use of the DET-AC III Master system with simultaneous use of an automatic door opening "ADO".....	47
6.2.7	Setting air flow calibration.....	48
6.2.8	Checking the failure and alarm function.....	48
6.3	Installation and commissioning of additional electrical devices.....	51
6.3.1	Potential-free contacts.....	52
6.3.2	External alarm devices.....	53
6.3.3	Monitoring system.....	54
6.3.4	External fill level monitoring and external tank.....	54
6.3.5	Door contact / blocking.....	55
6.3.6	Combination of systems.....	58
6.3.7	Manual call point.....	63

7	Alarms and failures	64
8	Display and control elements	66
8.1	LED displays.....	67
8.2	Buttons.....	67
8.3	Display.....	68
8.3.1	Message display.....	68
8.3.2	Main menu.....	70
8.4	Settings and displays.....	71
8.5	Reviewing the event memory.....	72
8.6	Air flow calibration.....	73
8.6.1	Automatic calibration of the air flow monitoring.....	74
8.6.2	Manual calibration of the air flow monitoring.....	75
8.6.3	Setting the integration time for the air flow monitoring (filter time).....	76
8.7	Inside temperature.....	77
8.8	Lamp test.....	77
8.9	Menu "Version information".....	77
8.10	Revision.....	80
8.11	Maintenance.....	81
8.12	Maintenance menu.....	81
8.12.1	Extinguishing agent monitoring filter time.....	83
8.12.2	Battery change.....	83
8.12.3	Battery state.....	84
8.12.4	Measuring alarm device.....	85
8.12.5	Inside temperature.....	86
8.12.6	Operating hours counter.....	86
9	Messages display	88
10	Maintenance program	92
10.1	Installing the maintenance program.....	92
10.2	Homepage.....	93
10.3	Project.....	94
10.4	Event memory.....	94
10.5	Firmware.....	94
10.6	Customer data.....	95

10.6.1	General.....	95
10.6.2	Components.....	95
10.6.3	Timeouts.....	96
10.6.4	Threshold values.....	96
10.7	Operation.....	97
11	Maintenance.....	99
11.1	Regular checks by the owner.....	99
11.2	Inspection, maintenance and repairs by the Authorized Distributor.....	100
11.2.1	Checking for proper installation.....	104
11.2.2	Checking for external damage.....	104
11.2.3	Recording the WA No. / Part No. / F. No.....	104
11.2.4	Recording the date of the current maintenance / inspection.....	104
11.2.5	Recording the current version.....	104
11.2.6	Checking and recalibrating the air flow measured values.....	104
11.2.7	Checking current fault messages, history since last maintenance.....	105
11.2.8	Performing a lamp test.....	105
11.2.9	Checking the discharge nozzle for contamination.....	105
11.2.10	Checking the temperature indicator.....	105
11.2.11	Checking the setting of date and time.....	105
11.2.12	Checking the set integration time for air flow monitoring.....	105
11.2.13	Checking the last battery change.....	105
11.2.14	Checking the function of the door contact switch.....	106
11.2.15	Checking the blocking switch.....	106
11.2.16	Checking for proper connection of the transmission.....	106
11.2.17	Checking whether shutdown occurs.....	106
11.2.18	Reading out and transferring data.....	106
11.2.19	Checking the electrical connections.....	106
11.2.20	Cleaning the pipe system.....	106
11.2.21	Changing the batteries.....	107
11.2.22	Changing the battery "control card CPU3".....	107
11.2.23	Checking the DIP switch on the control card CPU3.....	107
11.2.24	Checking the networking of the systems.....	107
11.2.25	Changing the filter.....	108
11.2.26	Checking for contamination in the housing.....	108
11.2.27	Checking loss monitoring.....	108

11.2.28	Power supply.....	108
11.2.29	Cover seal.....	109
11.2.30	Checking the total weight.....	109
11.2.31	Testing the release.....	109
11.2.32	Changing fire detectors.....	109
11.2.33	Changing the tank.....	110
11.2.34	Concluding the inspection.....	110
11.3	Repairs after a release.....	110
11.3.1	Safety instructions for the tank change.....	111
11.3.2	Removal.....	112
11.3.3	Disposal of the old tank and installation of a new tank.....	114
11.4	Firmware update.....	115
12	Spare parts, accessories, consumables, and tools.....	116
13	Final shutdown, disassembly, and disposal.....	118
13.1	Final shutdown and disassembly.....	118
13.2	Disposal.....	118
14	Technical data.....	120
15	Index.....	123

1 Legal note



Deutsch:

Produkt nur einbauen, inbetriebnehmen und warten, wenn diese Anleitung klar verstanden wird.
Produkt nur bedienen, wenn die nachfolgende Anleitung klar verstanden wird.



Français:

N'installer, ne mettre en service et n'entretenir le produit que si les présentes instructions ont été clairement comprises.
N'utiliser le produit que si les instructions suivantes ont été clairement comprises.



Български:

Инсталирайте, пуснете в експлоатация и поддържайте продукта само ако тази инструкция е ясно разбрана.
Използвайте продукта само ако тази инструкция е ясно разбрана.



Eesti keel:

Paigaldage toode, võtke see kasutusele ja hooldage seda ainult siis, kui saate sellest juhendist selgelt aru.
Kasutage toodet ainult siis, kui saate alljärgnevast juhendist selgelt aru.



Ελληνικά:

Η εγκατάσταση, θέση σε λειτουργία και συντήρηση του προϊόντος επιτρέπονται μόνο εάν οι παρούσες οδηγίες έχουν γίνει κατανοητές.
Μην λειτουργείτε το προϊόν εάν δεν έχετε κατανοήσει πλήρως τις παρακάτω οδηγίες.



Italiano:

Montare il prodotto, metterlo in funzione ed eseguirne la manutenzione solo se si sono comprese appieno le seguenti istruzioni.
Utilizzare il prodotto solo se si sono comprese appieno le seguenti istruzioni.



Latviešu:

Produkta iemontēšanu, ekspluatācijas sākšanu un tehniko apkopi veikt tikai tad, ja dotā instrukcija ir pilnībā saprasta.
Produktu lietot tikai tad, ja dotā instrukcija ir pilnībā saprasta.



Malti:

Installa, ikkummissjona u wettaq manutenzjoni fuq il-prodott biss jekk dawn l-istruzzjonijiet jinftiehm u b'mod ċar.
Toperax il-prodott biss jekk l-istruzzjonijiet li ġejjin jinftiehm u b'mod ċar.



Polski:

Produkt należy instalować, uruchamiać lub konserwować tylko wtedy, gdy poniższe instrukcje są w pełni zrozumiałe.
Produkt może być używany tylko wtedy, gdy poniższe instrukcje są w pełni zrozumiałe.



English:

Do not install, start up and maintain the product unless you have clearly understood these instructions.
Do not operate the product unless you have clearly understood the instructions below.



Español:

Montar el producto, ponerlo en funcionamiento y realizar el mantenimiento solo cuando se hayan comprendido claramente estas instrucciones.
Utilizar el producto solo cuando se hayan comprendido claramente las siguientes instrucciones.



Dansk:

Du må kun installere, idriftsætte og vedligeholde produktet, hvis du har forstået denne vejledning til fulde.
Du må kun betjene produktet, hvis du har forstået denne vejledning til fulde.



Suomi:

Tuotteen asennus, käyttöönotto ja huolto ovat sallittuja vain, jos tämä ohje ymmärretään selvästi.
Tuotetta saa käyttää vain, jos jäljempänä oleva ohje ymmärretään selvästi.



Gaeilge:

Ná déan an táirge a shuiteáil, a thosú agus a chothabháil mura dtuigeann tú na treoracha seo go soiléir.
Ná oibrigh an táirge mura dtuigeann tú go soiléir na treoracha thíos.



Hrvatski:

Ugradite, puštajte u pogon i održavajte proizvod samo ako su ove upute jasno razumljive.
Koristite proizvod samo ako su sljedeće upute jasno razumljive.



Lietuvių k.:

Produktą montuokite, pradėkite jo eksploataciją ir techninės priežiūros darbus vykdykite tik tuomet, jei aiškiai suprantate šią instrukciją.
Produktą naudokite tik tuomet, jei aiškiai suprantate šią instrukciją.



Nederlands:

Product alleen installeren, in gebruik nemen en onderhouden, als de volgende instructies goed zijn begrepen.
Product alleen bedienen, als de volgende instructies goed zijn begrepen.



Português:

Instalar, colocar o produto em funcionamento e fazer a manutenção somente se as instruções a seguir forem claramente compreendidas.
Utilizar o produto somente se as instruções a seguir forem claramente compreendidas.

**Română:**

Montați produsul, puneți-l în funcțiune și întrețineți-l numai dacă instrucțiunea următoare este înțeleasă clar.

Utilizați produsul numai dacă instrucțiunea următoare este înțeleasă clar.

**Slovenčina:**

Namontujte, spustite do prevádzky a udržiavajte výrobok iba vtedy, pokiaľ ste jasne pochopili tento návod.

Obsluhujte výrobok iba vtedy, pokiaľ ste jasne pochopili tento návod.

**Čeština:**

Namontujte, spustíte do provozu a udržujte produkt pouze tehdy, když jste jasně pochopili tento návod.

Obsluhujte produkt pouze tehdy, když jste jasně pochopili následující návod.

**Svenska:**

Montera produkten, ta den i drift och underhåll den endast om du förstår denna instruktion. Betjäna produkten endast om du förstår den efterföljande instruktionen.

**Slovenščina:**

Izdelek vgradite, zaženite in vzdržujte samo, če ste dobro razumeli navodila v nadaljevanju. Izdelek upravljajte samo, če ste dobro razumeli navodila v nadaljevanju.

**Magyar:**

Csak akkor építse be a terméket és végezzen karbantartást, ha a következő útmutatót egyértelműen megértette.

Csak akkor kezelje a terméket, ha a következő útmutatót egyértelműen megértette.

2 General

This document contains important information for working safely and efficiently with the active extinguishing system DET-AC III Master (referred to below as the "system").

⚠ This document is intended for qualified personnel ↪ *Chapter 3.6 "Qualification of personnel" on page 18.*

2.1 Overview

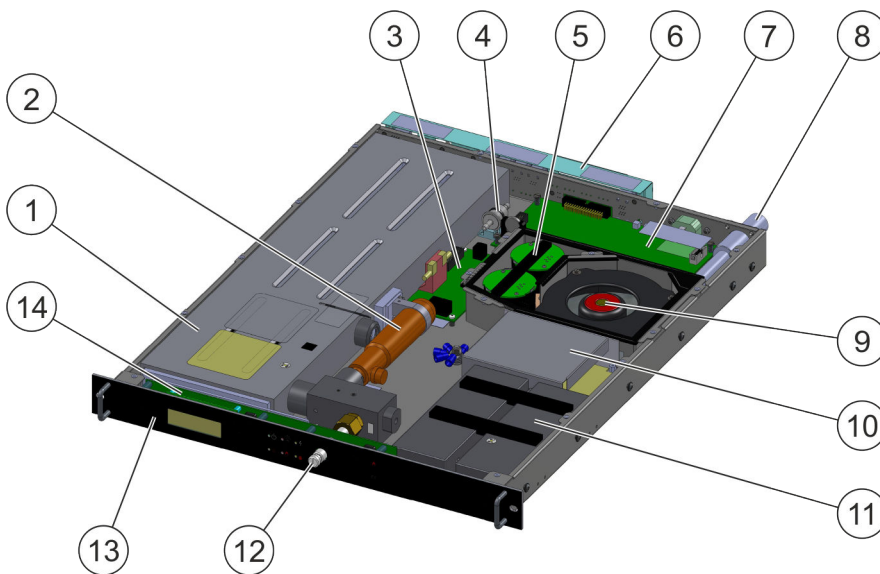

Fig. 1: Structure of the system

- | | |
|--|---|
| 1 Tank (extinguishing agent container) with fill level monitoring and release device | 7 Control card CPU3 |
| 2 Propellant cartridge | 8 Suction pipe connection |
| 3 Detector interface | 9 Fan |
| 4 Air flow monitoring filter | 10 Power supply |
| 5 Fire detectors | 11 Emergency power supply (batteries) |
| 6 Connection strip (connection technology card / network interface card) | 12 Discharge nozzle |
| | 13 Front panel with display and control panel |
| | 14 Control panel card BT3 |

2.2 Abstract

The active extinguishing system DET-AC III Master, which is intended for installation in closed 19" cabinets (e.g. server, network or switch cabinets), is a stand-alone, compact unit that was developed to detect and extinguish fires.

Novec™ 1230 manufactured by 3M™ (FK-5-1-12) is used as the extinguishing agent which is discharged evenly in the extinguishing zone via a discharge nozzle. This extinguishes the fire by extracting heat energy from the flames.

Fire detection occurs by means of 2 fire detectors.

Alarms and failures can be transmitted to a superordinate position (building control technology or permanently manned location) via potential-free contacts, the Monitoring System CMC, the IoT interface or via the Power Distribution Unit PDU (Rittal products).

Network capability is established with one of the mentioned Rittal products.

The compact system with a space requirement of only one rack unit is intended for installation in the upper third of the closed 19" cabinet to be protected.

2.3 Scope of delivery

Designation	Unit	Part no.
Active extinguishing system DET-AC III Master	1	7338.121
Battery, 12 V / 2.3 Ah ¹⁾	2	4003368
Mains connection cable, C13 – C14 / 2.5 m (8.2 ft) / 10 A / 250 V AC / 3×1.0 mm ² (3×AWG 18)	1	924861
End-of-line resistor, 1.8 kΩ (for door contact / manual call point) ²⁾	2	675235
47R end-of-line resistor with 1N4007 rectifier diode for alarm device ²⁾	1	917751
470 Ω, 0.5 W resistor (for door contact / manual call point) ³⁾	1	675223
1K end-of-line resistor (for "RJ12 plug" door contact switch) ³⁾	1	908119
22K end-of-line resistor (for "RJ12 plug" door contact switch) ³⁾	1	906913
Rail, left ³⁾	1	915914
Rail, right ³⁾	1	915915
M4×6 oval head screw (for mounting the left and right rails on the system, side) ³⁾	12	889264
M5×16 oval head screw (for mounting the left and right rails on the 19" cabinet, rear) ³⁾	4	906928
M6×16 oval head screw (for mounting the front panel in the 19" cabinet) ³⁾	2	607284
Sign DET-AC III Master ³⁾	1	916087
"Gas-based extinguishing system – Danger to health" warning sign, German/English (for marking on the 19" cabinet)	2	933512
Operating instructions, German ³⁾	1	916004
Operating instructions, English ³⁾	1	916005
3M™ Novec™ 1230 safety data sheet, German ³⁾	1	917711

Designation	Unit	Part no.
3M™ Novec™ 1230 safety data sheet, English ³⁾	1	917712
DET-AC safety data sheet, German ³⁾	1	920329
DET-AC safety data sheet, English ³⁾	1	920330
¹⁾ pre-assembled ²⁾ assembled ³⁾ included in pack		

Accessories

- Suction pipe system (part number 7338.130)
- Access sensor (part number 7030.128)
(hereinafter also referred to as "door contact switch")
- Extension cable for sensors (part number 7320.814), for connection to a Rittal monitoring system
- Variable-depth slide rails (part number 5302.035), optional
- Sealing kit (part number 7338.135)
The sealing kit contains material for sealing the brush strips in the roof plate of the VX IT network and server cabinet and for sealing the LCP (Liquid Cooling Package).

Optional:

One of the following Rittal products must be used to establish network capability:

- CMC Processing Unit
- IoT interface
- Power Distribution Unit PDU
 - metered
 - metered plus
 - switched
 - managed

2.4 Limitations of liability

All specifications and information provided in this operating instruction have been compiled in consideration of all applicable standards and regulations as well as the state of the art. The manufacturer accepts no liability for the following damage:

- Failure to follow this operating instruction
- Failure to follow local provisions and any regulations regarding the maintenance of fire extinguishing systems
- Operating the system in environmental and usage conditions other than the ones for which the system has been designed ↪ *Chapter 14 "Technical data" on page 120*
- Use for other than the intended purpose
- Unauthorized technical changes

- Use of components not included in the system's scope of delivery
- Non-compliance with maintenance intervals
- Non-performance of maintenance
- Maintenance errors due to non-compliance with current maintenance instructions / current maintenance notes of the manufacturer
- Damage for which a third party is to blame
- Intentional damage/manipulations
- Damage resulting from an unauthorized modification to the system
- Repairs not carried out according to regulations
- Actions that are not in the area of those described in this operating instruction

Use of the system must comply with local regulations, laws and standards. The owner is responsible for the appropriate selection, intended use and compliance with all standards, codes and ordinances.

The construction and use of the system described in this operating instruction are only to be used for the purposes that are shown and described. The manufacturer or private labeler provides no warranty or guarantee for uses not described in this specification or for uses that do not comply with legal and local regulations.

Graphs or reports used in this operating instruction are for illustrative purposes only, are not representative or descriptive of any specific design and can deviate from the actual version of the system.

The manufacturer or private labeler and its representatives disclaim use of the depictions, graphs and reports for any purpose other than illustration; any other application or usage is solely the responsibility of the owner.

3 Safety

This section provides an overview of all important aspects that are essential for the protection of personnel as well as safe and trouble-free operation. Additional task-specific safety instructions will be provided in the sections that refer to the individual life stages of the plant.

3.1 Safety and warning notices

Safety and warning notices are marked with symbols in this document. The introductory signal words express the extent of the danger in each case.

WARNING

This signal word describes a danger with a medium risk level. If the danger is not avoided, it may result in death or serious injury.

CAUTION

This signal word describes a danger with a low risk level. If the danger is not avoided, it may result in minor or moderate injury.

NOTICE

This signal word describes a danger with a low risk level. If the danger is not avoided, it may result in property and environmental damage.

Further markings

INFORMATION





This marking emphasizes useful tips and recommendations as well as information for efficient and trouble-free operation.

In instructions, this marking starts with the symbol **i**.

3.2 Warnings in instructions

Warnings can refer to specific, individual instructions. Such warnings are embedded in the instructions so that they do not interrupt the reading flow when executing the action. The signal words described above are used.

Example:

1.  Unscrew screw.
2.   **CAUTION! Clamping danger on the cover.**
Carefully close the cover.
3.  Tighten screw.

3.3 Intended use

This system is designed exclusively for the intended use described here.

The system is designed exclusively to detect and extinguish smoldering or developing fires in closed 19" switch cabinet systems.

The system must only be operated using the extinguishing agent Novec™ 1230 by 3M™.

The system must only be used in areas which personnel do not enter.

Typical applications for using the system is the protection of closed 19" switch cabinets. This, for example, includes:

- IT, server and network technology
- Production controls
- Telecommunications equipment
- Power supply and control systems

The system may only be operated within the operating conditions specified in [↪ Chapter 14 "Technical data" on page 120](#).

Intended use also includes compliance with all specifications regarding mounting, installation, checking, inspection and maintenance, which are described in this operating instruction:

- [↪ Chapter 6 "Assembly and installation" on page 35](#)
- [↪ Chapter 11 "Maintenance" on page 99](#).

Incorrect use

Any other use exceeding or deviating from the scope of intended use is considered incorrect use.

WARNING

Danger due to misuse!

Misuse of the system can lead to personal injury and property damage.

- No structural changes to the device to be protected or to the system may be performed.
- Do not use the device to be protected in any way that is contrary to that which was considered by the trained Authorized Distributor.
- Do not block the discharge nozzles.

The system must **not** be used for the following incendiaries:

- Chemicals that release oxygen.
- Mixtures containing oxidizing substances (e.g. sodium chlorate, sodium nitrate, explosives, gunpowder).
- Chemicals capable of thermally decomposing autonomously (e.g. certain organic peroxides).
- Reactive metals (e.g. sodium, potassium, magnesium, titanium or zirconium) and reactive hybrids or metal amides.

The system must **not** be used under the following operating conditions:

- Hot surfaces above 500 °C (932 °F), which due to operational conditions have been heated to temperatures in excess of the extinguishing agent's decomposition temperature.

Structural changes

This system has been tested for the intended use. Consult an Authorized Distributor if changes to the device are planned.

3.4 Safe operation

The system described here was manufactured in accordance with state-of-the-art technology and recognized safety rules and exhibits a high degree of operational safety.

Nevertheless, improper or non-intended use / application of this system can cause impairments to the system or to other assets.

The system must only be used in a fully functional, undamaged state.

The information provided in this operating instruction regarding installation, operation and maintenance of the system is intended to aid proper, safe and failure-free operation. As regulations in this regard can deviate from each other due to worldwide use, the applicable national regulations and laws at the site of operation are to be observed in so far as they contradict the information provided in this operating instruction. As a general rule, the following information in particular is to be observed / adhered to:

- National safety and accident prevention regulations.
- National standards and laws; in particular those concerning hazard detection systems.
- National assembly and construction regulations.
- Generally recognized rules of technology.
- This operating instruction and the warnings and safety instructions contained within it.
- Parameters and technical data of this system.

If it can be assumed that safe operation is no longer possible (e.g. in the event of damage), the system is to be taken out of service immediately and secured against accidental commissioning.

Spare parts

Only original spare parts may be used ↪ *Chapter 12 "Spare parts, accessories, consumables, and tools" on page 116.*

3.5 General dangers

The following section lists residual risks which could occur even from intended use of the system.

In order to reduce the risk of personal injury or property damage and to avoid hazardous situations, follow all safety and warning notices listed in this document.

3.5.1 General dangers associated with fire extinguishing systems

 **WARNING**

Risk of injury from faulty release!

A faulty release of the system may cause injuries and property damage.

- Release the system via manual call points only in the event of a fire.
 - Protect the manual call points in the extinguishing zone from inadvertent actuation.
 - Block the system before performing any work in the extinguishing zone generating heat and smoke.
-

 **WARNING**

High voltage!

An imminent risk of death or severe physical injury due to electric shock.

- All tasks at the open system may only be performed by electricians with appropriate training.
-

3.5.2 Dangers when activating the system

 **WARNING**

Risk of injury from developing products of decomposition and fire smoke!

Fires generate decomposition products which may lead to chronic health impairments if inhaled and if there is contact with the skin.

- Do not use the system if, in normal operation, surface temperatures in excess of 500 °C (932 °F) are to be expected.
 - Keep the extinguishing zone closed in the event of a fire, e.g. do not open any of the switch or server cabinet doors.
 - After a fire, the extinguishing zone is not to be opened by the safety officer until the danger of re-ignition has subsided.
-

 **WARNING**

Risk of injury from shock!

The release of the system involves sudden noises from the discharged agent which may surprise persons to the extent that they suffer shock.

- Inform all persons staying close to the extinguishing zone about the existence of the system and the possibility of its sudden release.
 - Make persons familiar with the procedures required in the event of an alarm, a fire or release of the system.
-

⚠ WARNING

Risk of injury from noise!

High noise levels due to acoustical alarms (e.g. signal horns) can cause hearing damage.

- Stay out from the immediate vicinity of acoustic alarm equipment.
-

NOTICE

Property damage from cooling ambient air!

The discharged extinguishing agent extracts heat from the ambient air contained in the extinguishing zone. This cools down the extinguishing zone by as much as 20 °C (36 °F) when fighting a fire.

- Do not mount components that are sensitive to cold and varying temperatures in the immediate vicinity of the discharge nozzle.
-

NOTICE

Property damage from falling and flying objects!

The discharge velocity of the extinguishing agent may cause unsecured objects to tip over or become airborne.

- Do not place any loose objects into the outflow area of the discharge nozzle.
-

3.6 Qualification of personnel

⚠ WARNING

Inadequately qualified persons pose a hazard!

Inadequately qualified persons cannot assess the risks involved in handling the system. They expose themselves and others to the risk of severe or fatal injuries.

- All work should be carried out only by persons qualified to do so.
-

Before starting any work, the following persons must be identified who have the knowledge required to operate the system:

- A person to be responsible for the system
- An operator/person authorized by the operator

Tasks may only be performed by persons who can be reasonably expected to perform the tasks reliably. Persons whose reaction time is impaired (e.g. by drugs, alcohol, or medication) are not authorized.

All work must be carried out only by persons who meet the following prerequisites:

- They have read and understood this document, including the safety notices and warning notices.
- They are familiar with basic regulations on occupational safety and accident prevention.
- They have been given instruction on handling the system.

The various tasks described in this document require that the persons responsible for them have different qualifications. These qualifications, which are referred to again at the beginning of the respective section of this document, are specified below:

Authorized Distributor

The Authorized Distributor has verifiably undergone training provided by the manufacturer during which the company was made familiar with the knowledge and procedures necessary to install, commission and service fire suppression systems in a safe manner.

Person in charge of the system

The person in charge of the system has verifiably been given instructions by the company that installed the system as to the specifics of the tasks entrusted to him/her and all possible dangers that may arise from improper conduct.

The person in charge of the system has been appointed by the owner as the person who is responsible for the correct and proper completion of the work and inspections performed on the system.

Qualified electrician

The qualified electrician is capable of performing work on electrical systems and independently detecting and avoiding any possible risks due to his/her long years of expertise and experience and his/her familiarity with all applicable standards and regulations.

A qualified electrician must also provide proof of his/her professional qualification that confirms his/her capacity to perform work on electrical systems.

The qualified electrician must comply with the provisions of all applicable legal regulations regarding accident prevention.

Qualified specialist personnel

Qualified specialist personnel are persons with the following qualifications and authorizations:

- These persons are qualified for the respective activities as a result of their education, experience, and participation in a training course conducted by the manufacturer or distributor.
- These persons have the appropriate knowledge of standards, directives, accident prevention regulations, and operating conditions.
- These persons have been authorized by the person responsible for the safety of the system to carry out the necessary activities and are capable of recognizing and avoiding possible risks.

Unauthorized persons



Risk of injury for unauthorized persons!

Persons who do not meet the requirements described are not familiar with the hazards connected with the function (e.g. activation and/or isolation) of the system. This poses a risk of injury.

- Keep unauthorized persons away from control equipment.
 - In case of doubt, instruct persons to move away from control equipment.
-

3.7 Instruction

The Authorized Distributor must instruct the owner's person in charge of the system in the handling of the system and subsequently hand over the operating instruction to this person. For better traceability an instruction report must be drawn up with at least the following contents:

- Date of the instruction
- Name of the person being instructed
- Content of the instruction
- Name of the instructor
- Signatures of the instructed person and the instructor
- Part number and serial number of the system.

3.8 Personal protective equipment

Personal protective equipment is designed to protect people from risks to their safety and health at the workplace.

Personnel must wear personal protective equipment, which is specially indicated in the individual sections of this document, when carrying out the various tasks.

Additional personal protective equipment may also be required due to local conditions, directives, company specifications, etc.

The following describes the required personal protective equipment, which is referred to again at the beginning of the respective sections of this document:

Protective goggles



Protective goggles cover the entire area of the eyes (including the sides) and are used to protect the eyes from the extinguishing agent and from particles that are whirled up by the extinguishing agent.

Safety footwear



Safety footwear protects the feet from crushing injuries, falling parts, and slipping on slippery substrates.

Safety gloves



Safety gloves are used to protect the hands from friction, abrasions, puncture wounds or deeper wounds as well as coming into contact with hot surfaces.

Safety goggles



Safety goggles cover the entire eye area (also on the side) and are used to protect the eyes, e.g. against chemicals, raised particles or pressurized gases or liquids.

3.9 Operator's responsibility

3.9.1 Owner

The owner is the person or entity that operates the system himself/itself for commercial or economic purposes, or who transfers the device to a third person for use/application, and who bears the legal responsibility for protecting the user, personnel, or third parties.

3.9.2 Owner's obligations

- It is the owner's responsibility to ensure that the system complies with the local provisions and regulations applying to the operation of extinguishing systems using the extinguishing agent Novec™ 1230 and verify the system's operability. In this regard, the following particularly applies:
 - The owner must comply with the applicable regulations as well as all additional local regulations applying to the operation of the system.
 - The owner must always observe the inspection intervals specified in this operating instruction.
 - The owner must perform these inspections and operate the system following the procedural instructions described throughout this operating instruction.
 - The owner must document the results of the inspections in the log book.
 - The owner must report any detected defects and/or damage to the Authorized Distributor, which he/she is not authorized to rectify independently.
 - The owner must document all shutdowns and failures the system experiences in the log book of the system.
- The "Occupational Safety and Health Act" of 1970 specifies that a safe workplace must be provided at all times for execution of tasks. To this end, the owner must ensure that the system is inspected and operated in accordance with all applicable commercial, industrial, local, federal and state laws, standards and regulations.
- The owner must ensure that the personnel performing the work have the qualifications necessary to complete the task.
- The owner must ensure that all employees who handle the system have read and understood this operating instruction. In addition, the owner must train personnel and inform them of dangers at regular intervals.
- The owner must ensure that all employees working in the extinguishing zone of the system have been informed of the existence of the system and know the risks involved and the steps necessary to handle the system (e.g. behavior in the event of a fire or inadvertent release).

- The owner must appoint a person in charge of the system, who will be instructed by the Authorized Distributor about how to safely perform tasks and checks at the owner's site of operation. The owner will confirm in the documentation of the Authorized Distributor that these instructions have been given.
- The owner must confirm to the Authorized Distributor that the system's function and mode of operation have been understood and the system was ready for operation when accepted by the owner.
- The owner must ensure the availability of substitute extinguishing agents suitable for fire fighting in case the system is taken out of operation/disassembled.

3.10 Responsibility of the Authorized Distributor

3.10.1 Authorized Distributor

The Authorized Distributor is the entity that installs the system, commissions the system, and can perform the service on the system.

3.10.2 Obligations of the Authorized Distributor

- The Authorized Distributor must ensure that the extinguishing system complies with the provisions and regulations applicable for installation of extinguishing systems in enclosed equipment and that the system has been correctly chosen for the protection of this equipment (correct nominal fill, density given, ...). In this regard, the following particularly applies:
 - The Authorized Distributor must comply with the applicable local regulations, and consider these regulations in the selection of the system.
 - The Authorized Distributor must take the current state of the technology into consideration at all times.
- The "Occupational Safety and Health Act" of 1970 specifies that a safe workplace must be provided at all times for execution of tasks. To this end, the Authorized Distributor must ensure that the system is erected, installed, and maintained in accordance with all applicable commercial, industrial, local, federal and state laws, standards and regulations.
- The Authorized Distributor must label the system and affix all necessary information where it is permanently visible.
- The Authorized Distributor must ensure that the personnel performing the tasks have the qualifications necessary for execution of the tasks.
- The Authorized Distributor must instruct a responsible person appointed by the owner in the safe execution of the tasks and inspections that must be executed by the owner, and document execution of this instruction.
- The Authorized Distributor must document the actual status of the system at the time of transfer and inform the owner's responsible person of the actual status.

3.11 Signage

⚠ WARNING

Risk in conjunction with illegible signage!

Over time, stickers and signs can get dirty or become illegible for other reasons, so that risks can no longer be recognized and necessary operating instructions can no longer be adhered to. This will lead to a risk of injury.

- Keep all safety, warning and operating instructions easily legible at all times.
- Immediately replace damaged signs or stickers.

Marking of the extinguishing zone

The operator must mark the extinguishing zone/control cabinet with the warning sign "Gas-based extinguishing system – Danger to health!"¹⁾ (Fig. 2) to draw awareness to the presence of the system and its associated dangers.



Fig. 2: Marking of the extinguishing zone (example)

¹⁾ Included in the scope of delivery.

3.12 Environmental protection

NOTICE

Danger to the environment due to incorrect handling of materials that can harm the environment!

In case of incorrect handling of materials that can harm the environment, especially improper disposal, there can be significant damage to the environment.

- Always observe the notes below about the handling of materials that can harm the environment and their disposal.
- If materials that can harm the environment accidentally escape into the environment, take suitable measures immediately. In case of doubt, inform the responsible authority about the damage and ask what suitable measures to take might be.

Extinguishing agent Novec™ 1230

The extinguishing agent has been classified as slightly reactive to water. It must be disposed of in accordance with all applicable local waste disposal regulations. Observe the safety data sheet provided by the extinguishing agent's manufacturer 3M™.

The photolytic half-life of the extinguishing agent is 3 – 5 days. The global warming potential (GWP) value is 1, while the value of the ozone decomposition potential (ODP) is 0.

3.13 Behavior in the event of a fire

3.13.1 Preventive steps

- Always be prepared for fires and accidents!
- Keep first-aid equipment (first-aid kit, blankets, etc.) and substitute extinguishing agents (e.g. fire extinguisher) in proper working order and readily available.
- Familiarize personnel with accident prevention, first aid and rescue equipment as well as options for releasing the system manually.
- Keep access paths clear for rescue vehicles.

3.13.2 Steps in the event of a fire

WARNING

Risk of death due to fire!

Severe fire smoke may develop when a fire erupts and while the fire is being extinguished. Fire smoke development may result in severe airway damage or death.

- Keep the extinguishing zone closed in the event of a fire, e.g. do not open any of the switch or server cabinet doors.
- After a fire, do not have the extinguishing zone opened by the safety officer until the danger of re-ignition has subsided.
- Shut down all consumers of the power supply that are in the cabinet.

Take the following steps when a fire erupts:

- Initiate first-aid measures if necessary.
- Alert any endangered persons in the adjoining areas.
- Notify the fire department and/or emergency medical services.
- Notify the person in charge at the system's location.

4 Transport and packaging

Personnel: ■ Qualified specialist personnel

CAUTION

Risk of injury due to falling or toppling packaged items!

Packaged items can have an eccentric center of gravity. If handled incorrectly, the packaged item may topple or fall. Toppling or falling packaged items may cause injuries.

- Lift and transport the packaged item carefully.

NOTICE

Property damage due to improper transport!

Improper transport may cause transported items to fall down or topple over. This may cause significant and costly property damage.

- Proceed carefully during the unloading of the transport pieces during delivery as well as during the transport to its final destination and comply with the symbols and information displayed on the packaging.
- Only remove packaging immediately prior to installation.

4.1 Transport inspection

1. ➤ Check all system parts for completeness and transport damage immediately upon receipt.
2. ➤ If there is apparent external transport damage, proceed as follows:
Note the scope of the damage on the transport documents or on the freight forwarder's delivery ticket.

INFORMATION

Report every complaint as soon as it is detected. Claims for damage compensation can only be asserted within the applicable period specified for the reporting of complaints, which was agreed with the private labeler.

4.2 Transport

Observe the following during transport:

- **Transporting the complete system:**
 - **Caution** Dangerous goods, according to section 14 in the respective valid safety data sheet. Transport only permitted by trained personnel.
 - Safety data sheet¹⁾ for this system.
 - Safety data sheet¹⁾ for Novec™ 1230 manufactured by 3M™.
 - Safety data sheet¹⁾ for battery part no. 4003368.
- **Transporting a spare tank system:**
 - **Caution** Dangerous goods, according to section 14 in the respective valid safety data sheet. Transport only permitted by trained personnel.
 - Safety data sheet¹⁾ for the tank system (spare part).
 - Safety data sheet¹⁾ for Novec™ 1230 manufactured by 3M™.

¹⁾ The safety data sheets are included with the system.

Observe the country-specific provisions for export!

INFORMATION

Anyone who ships hazardous airfreight must be trained in accordance with IATA-DGR 1.5.

CAUTION

Danger due to faulty release!

The faulty release of the system may result in injury or property damage.

- Before the return transport of the complete system, switch the blocking switch (Fig. 3/arrow) to "Agent disconnect [blocked]" (Fig. 3/II).
 - Before transporting the complete system, disable the batteries: Press the "Battery OFF" (Fig. 4/1) battery button.
-

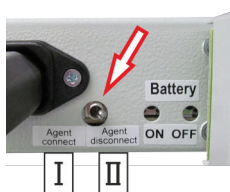

Fig. 3: Blocking switch

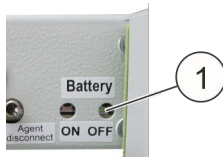

Fig. 4: Battery button

4.3 Packaging

Be sure to keep the packaging the system came in. The system can only be sent for maintenance or repair in the special original packaging it came in or in packaging equivalent to this.

Outer dimensions (width x depth x height)	675 x 875 x 210 mm
Weight	approx. 6.6 kg

Tab. 1: Data of the original packaging

5 Structure, function and connections

5.1 Structure

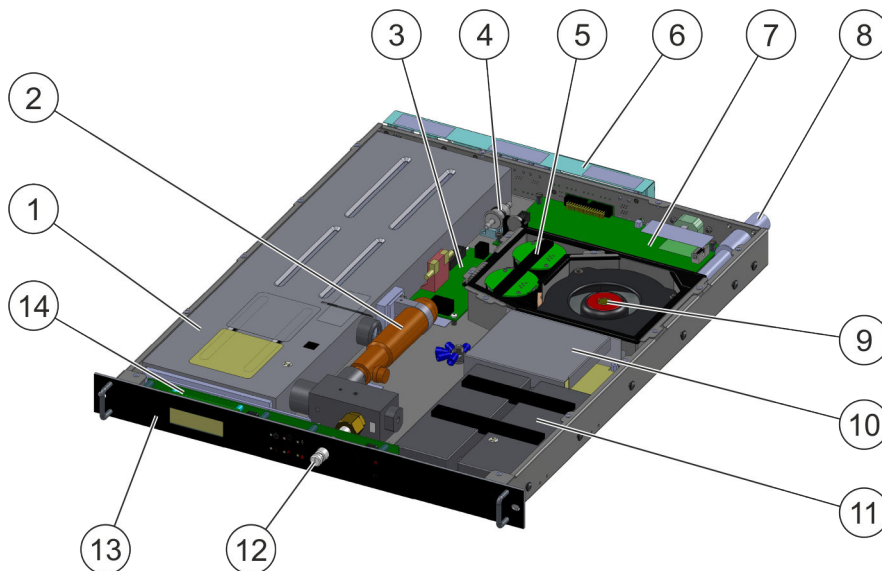

Fig. 5: Structure of the system

- | | |
|--|---|
| 1 Tank (extinguishing agent container) with fill level monitoring and release device | 7 Control card CPU3 |
| 2 Propellant cartridge | 8 Suction pipe connection |
| 3 Detector interface | 9 Fan |
| 4 Air flow monitoring filter | 10 Power supply |
| 5 Fire detectors | 11 Emergency power supply (batteries) |
| 6 Connection strip (connection technology card / network interface card) | 12 Discharge nozzle |
| | 13 Front panel with display and control panel |
| | 14 Control panel card BT3 |

5.2 Function

A fan (Fig. 5/9) continuously extracts air via pipe system from the switch cabinet to be protected. The extracted air is channeled through guide plates to the fire detectors (Fig. 5/5). A fire is detected as soon as the extracted air contains smoke aerosols.

The fire detectors are permanently monitored for operability by the electronic evaluation and control unit on the control card (Fig. 5/7).

If the first fire alarm threshold is reached, the electronic evaluation unit controls the process that is programmed for this occurrence: It shows the alarm state on the display (Fig. 5/13). In addition, the upper middle red LED (Fig. 6/1) flashes on the front panel. The relay output "Pre-alarm" is triggered.

If the second fire alarm threshold is reached (the relay output “*Fire alarm*” is triggered), the release device is triggered electrically upon conclusion of an analysis period, whereby the propellant cartridge (Fig. 5/2) is opened and the foaming agent flows into the tank (Fig. 5/1). The relay output “*Extinguishing*” is triggered. The foaming agent forces the extinguishing agent through the discharge nozzle (Fig. 5/12) into the switch cabinet to be protected so that the required concentration is generated.

The fill level monitoring, which is integrated in the tank, reports an extinguishing agent loss to the electronic evaluation unit, which then shows this failure (extinguishing agent loss) on the display. The relay output “*Common failure*” is triggered.

The power supply for the system is ensured by means of 2 sources. On the one hand, by a power supply unit (Fig. 5/10), which also takes control of charging the batteries for the emergency power supply (Fig. 5/11). On the other hand, by the emergency power supply itself, which is switched into parallel standby conditions. The emergency power supply is configured for a 4-hour uninterrupted operation of the system.

The operation and display of the current state of the system is by means of the control panel that is installed. To display the current state, this has, on the one hand, 6 LED indicators and, on the other hand, an LCD display. The LEDs serve to display the main alarms and failures (↪ Chapter 8.1 “LED displays” on page 67), while the individual states are shown in detail in the display as plain text.

If there are several messages pending, the cursor buttons can be used to switch between each individual message. The messages present are sorted according to priority and according to the order in which they were lodged. If the cursor buttons are not actuated within 30 seconds, the display switches back to the basic state.

The display of statuses by means of the LEDs (↪ Chapter 8.1 “LED displays” on page 67) on the control panel is independent from the content of the display and, consequently, from scrolling with the cursor buttons and always shows the current state of the system.

In addition to the cursor buttons, the control panel has 2 additional [*Reset*] buttons for resetting stored messages.

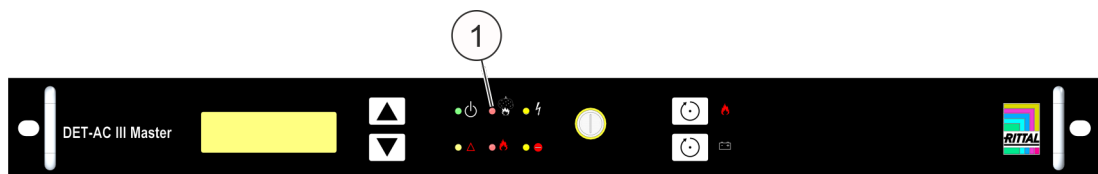

Fig. 6: Front view



Fig. 7: Rear view

5.3 Connections

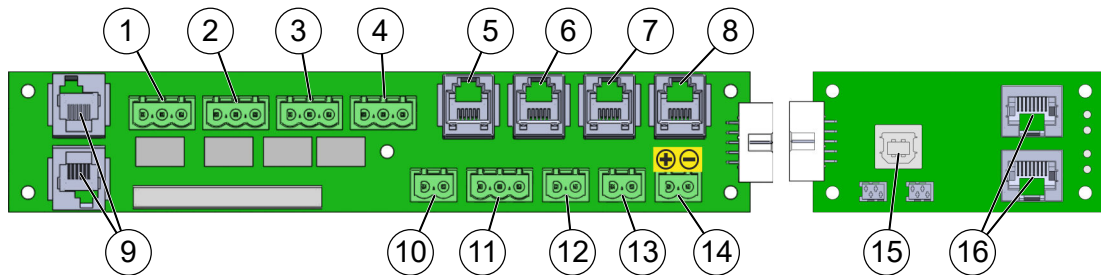

Fig. 8: "AT3 connection technology" card (left) and "NW network interface" card (right)

- 1 Connecting terminal for relay output „Pre-alarm” ↪ Chapter 5.3.1 “Relay outputs” on page 31
- 2 Connecting terminal for relay output „Fire alarm” ↪ Chapter 5.3.1 “Relay outputs” on page 31
- 3 Connecting terminal for relay output „Extinguishing” ↪ Chapter 5.3.1 “Relay outputs” on page 31
- 4 Connecting terminal for relay output „Common failure” ↪ Chapter 5.3.1 “Relay outputs” on page 31
- 5 Plug (RJ12) for door contact switch connection ↪ Chapter 5.3.2 “Door contact switch” on page 31
- 6 Plug (RJ12) for connection to Rittal Monitoring System („failure”) ↪ Chapter 5.3.3 “Interfaces to the Monitoring System” on page 32
- 7 Plug (RJ12) for connection to Rittal Monitoring System („fire alarm”) ↪ Chapter 5.3.3 “Interfaces to the Monitoring System” on page 32
- 8 Plug (RJ12) for connection to Rittal Monitoring System („pre-alarm”) ↪ Chapter 5.3.3 “Interfaces to the Monitoring System” on page 32
- 9 Connection for networking "DET-AC III Master - DET-AC III Slave" (RJ12-DEC) ↪ Chapter 5.3.9 “Connection for networking” on page 34
- 10 External alarm device ↪ Chapter 5.3.4 “Connection of external alarm device” on page 33 (delivery with terminating resistor 47 Ω and diode 1N4007)
- 11 Connection for external fill level monitoring and triggering of external tank ↪ Chapter 5.3.5 “Connection of external fill level monitoring and triggering of external tank” on page 33 (only activated in the aspirating smoke detection system EFD III)
- 12 Plug for manual call point (delivery with terminating resistor 1,8 kΩ) ↪ Chapter 5.3.6 “Manual call point connection” on page 33
- 13 Door contact plug 2 (delivery with two terminating resistors: 1,8 kΩ and 470 Ω) ↪ Chapter 5.3.2 “Door contact switch” on page 31
- 14 Power supply (U_B) ↪ Chapter 5.3.7 “Power supply” on page 34
- 15 USB port (type B) ↪ Chapter 5.3.8 “USB port” on page 34
- 16 CAN bus interface (RJ45) ↪ Chapter 5.3.3 “Interfaces to the Monitoring System” on page 32

Wiring

The following applies to wires: Each of the wires to be used must not be longer than 30 m (98 ft) per clamp connection. The minimum wire cross section is 0.5 mm² (AWG 21).

INFORMATION

The information provided above does not apply for the connection cable to the Monitoring System. Details on cabling and the cable cross-section can be found in the instructions of the Monitoring System.

Mechanical connection data of the clamp connection

Wire type	minimum	maximum
Conductor cross section rigid	0.34 mm ²	2.5 mm ²
Conductor cross section flexible	0.2 mm ²	2.5 mm ²
Conductor cross section flexible with wire end ferrule, without plastic sleeve	0.25 mm ²	2.5 mm ²
Conductor cross section flexible with wire end ferrule, with plastic sleeve	0.25 mm ²	2.5 mm ²
Conductor cross section flexible AWG/kcmil	24	12
Two conductors of equal cross sections rigid	0.2 mm ²	1 mm ²
Two conductors of equal cross sections flexible	0.2 mm ²	1.5 mm ²
Two conductors of equal cross sections flexible with wire end ferrule without plastic sleeve	0.25 mm ²	1 mm ²
Two conductors of equal cross sections flexible with twin wire end ferrule with plastic sleeve	0.5 mm ²	1.5 mm ²

5.3.1 Relay outputs

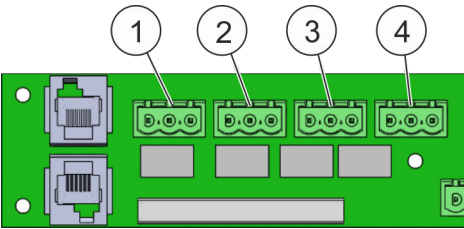

The system has four potential-free relay outputs (Fig. 9/1 to 4) each with one changeover contact.

Fig. 9: Relay outputs

5.3.2 Door contact switch

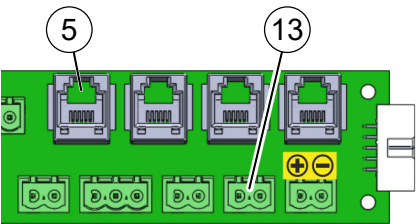

Fig. 10: Connections door contact switch

Door contact switches for the doors or the flaps (if an automatic door opening "ADO" by Rittal is used [Chapter 6.2.6 "Instructions for the use of the DET-AC III Master system with simultaneous use of an automatic door opening "ADO" on page 47](#)) of the 19" cabinet to be protected can be connected to connections "5" and "13" (Fig. 10) . This serves to monitor the cabinet door positions / flap positions ("ADO") of the object to be protected. When a door / flap of the 19" cabinet to be protected is opened, the extinguishing of the system is blocked and the message "Blocking by door cont." appears in the display.

The installation of door contact switches is described in [Chapter 6.3.5 "Door contact / blocking" on page 55](#).

5.3.3 Interfaces to the Monitoring System

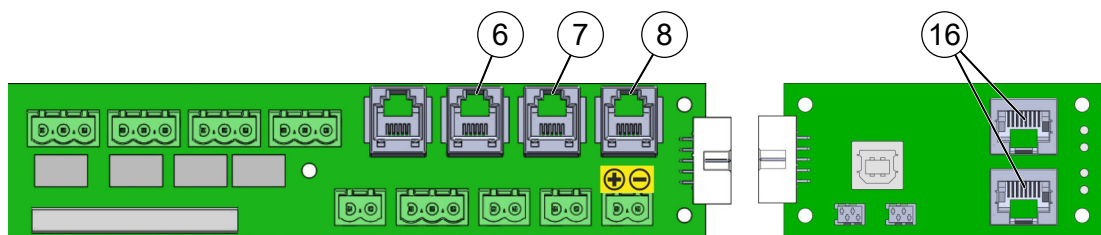

Fig. 11: CMC connections

The active extinguishing system DET-AC III Master has a CAN bus interface (Fig. 11/16) for connecting to various network-capable monitoring systems from Rittal. All states and messages that are listed in the table shown below can be queried through it.

Binary alarm states	Binary failure states	Messages
External release	Failure manual call point	Mains failure
Fire	Blocking by door cont.	Failure ignition cap.
Manual release	Failure door contact	
Pre-alarm	Failure power supply unit (PSU)	
	Failure battery	
	Failure air flow (pressure too high)	
	Failure air flow (pressure too low)	
	Failure detector 1	
	Failure detector 2	
	Failure communication	
	Failure extinguishing output	
	Extinguishing agent loss	
	Maintenance interval expired	
	Battery change required	

The CMC-TC is the predecessor to the CMC III and does **not** have a CAN-bus interface. The three states “Failure” (Fig. 11/6), “Fire alarm” (Fig. 11/7) and “Pre-alarm” (Fig. 11/8) can be queried via the RJ12 connectors (Fig. 11) using a CMC-TC I/O Unit.

5.3.4 Connection of external alarm device

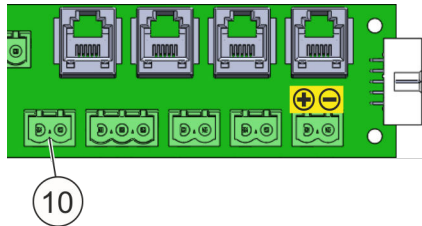

An acoustic or visual alarm device can be connected to the output "external alarm device" (Fig. 12/10). When the second fire alarm threshold is reached, the output switches the system voltage (21 V to 27 V) to the connection technology at an output current of ≤ 500 mA.

Fig. 12: Connection of external alarm device

5.3.5 Connection of external fill level monitoring and triggering of external tank

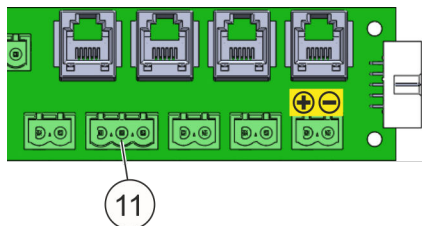

Connection of an external extinguishing container is only possible with variant EFD III. The external tank must be enabled in the program for this. When activated, the output (Fig. 13/11) switches the system voltage (21 V to 27 V) to the connection technology at an output current of ≤ 500 mA (with a maximum duration of 2 seconds).

Fig. 13: Connection monitoring and triggering of external tank

5.3.6 Manual call point connection

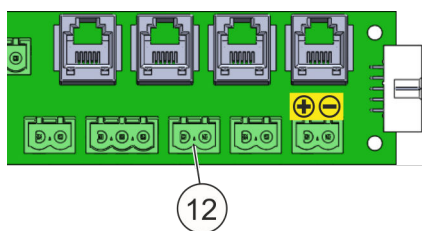

An externally accessible manual release device (e.g. manual call point) can be integrated in the manual call point connection (Fig. 14/12).

When connecting a release device, observe the 1.8 k Ω terminating resistor.

Fig. 14: Manual call point connection

5.3.7 Power supply

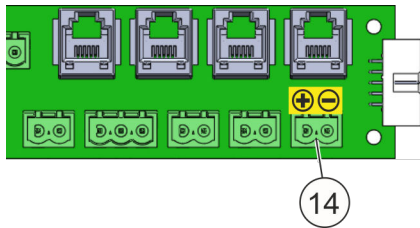

Fig. 15: Power supply

A 2-pole connection (Fig. 15/14) with an output current of 21 to 27 V DC is available for the DET-AC III Slave power supply in case of a DET-AC III Master and DET-AC III Slave combination of extinguishing units. This output is protected by a 500 mA fuse and supplied with emergency power.

In the case of the power supply, the voltage can drop to 19.4 V DC solely through batteries (in the event of mains failure). The power is shut off automatically below 19.4 V DC (deep discharge protection).

5.3.8 USB port

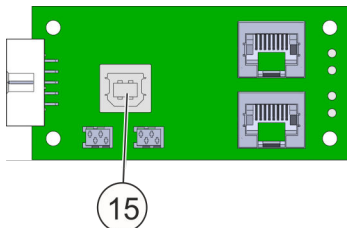

Fig. 16: USB port (type B)

Operating states or results can be downloaded and settings can be made via the USB port (Fig. 16/15). This, for example, includes reading out the error memory, setting the time and date, uploading new Firmware. Further information ↗ *Chapter 10 "Maintenance program" on page 92.*

INFORMATION

The USB port is not suitable as a power source.

5.3.9 Connection for networking

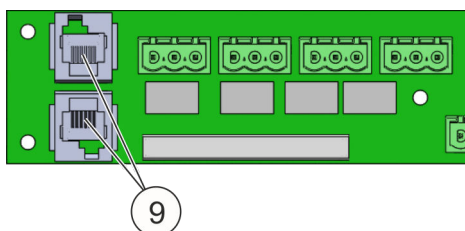

Fig. 17: Connection for networking

The system DET-AC III Slave is connected via the connections RJ12-DEC (Fig. 17/9). A total of up to four additional extinguishing systems can be controlled via the active extinguishing system. Further information in the operating instruction of the extinguishing system DET-AC III Slave.

6 Assembly and installation

INFORMATION

Mounting and installation of the system is to be performed solely by a trained Authorized Distributor.

6.1 Operating conditions and installation requirements

- Permissible ambient temperature range: +10 °C to +40 °C (+50 °F to +104 °F).
- Temperature differences between the integrated aspirating smoke detection system in the DET-AC III Master and the site of installation of the system must not exceed 5 °C (9 °F).
- Humidity: up to 96 %, relative, no condensation in the system.
- Low dust and low contamination in ambient air.
- Operation is not permissible in areas in which metallic or plastic decomposition gases or vapors can be extracted by the aspirating smoke detection system.
- Mounting the system in areas with shocks and vibrations is possible subject to certain conditions. The system has been tested according to standards DIN EN 54-20 and DIN EN 54-4 "Vibration".
- Operation only in closed cabinets. If cooling units are installed, make sure that no air exchange with the ambient air takes place (Fig. 18).
- Maximum permissible protection volumes: 2.8 m³ (98.9 ft³).
Prerequisite: The protected enclosure must not have any visible openings.
- One free rack unit in the upper third.
- A minimum available installation depth of 660 mm (26 in.).
- 100 to 240 Volt mains connection.

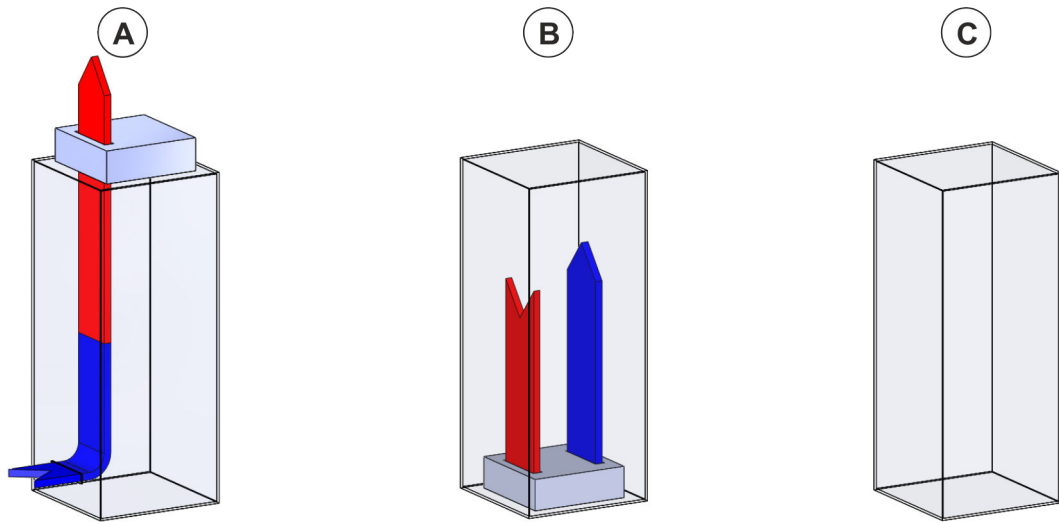

Fig. 18: Cooling air circuit 19" cabinet

- A Installation of the system in the 19" cabinet with open cooling air circuit **is only possible with restrictions** (the switch cabinet must be closed during the extinguishing)!
- B Installation of the system in the 19" cabinet with closed cooling air circuit is possible.
- C Installation of the system in the closed 19" cabinet without cooling air circuit and without visible openings is possible.

Installation of the system in differently equipped 19" cabinets is possible only following consultation with the Authorized Distributor.

6.2 Installation and commissioning

- Personnel:
 - Authorized Distributor
- Protective equipment:
 - Safety goggles
 - Safety gloves
 - Safety footwear

⚠ WARNING

Danger of reignition if devices are not shut down!

In order to prevent reignition, it is imperative that there is an energy shutdown of the devices within the protected enclosure when the extinguishing system is released.

- Use the floating contacts (Fig. 19/1 to 3) for the device shutdown that is to be realized by the operator.
- If shutdown upon release is not guaranteed, it is necessary to make sure that a manual fire fighting or shutdown measure, which
 - prevents reignition, is completed within the hold time of the extinguishing concentration,
 - or
 - that an automatic shutdown of the devices is completed in order to prevent reignition.

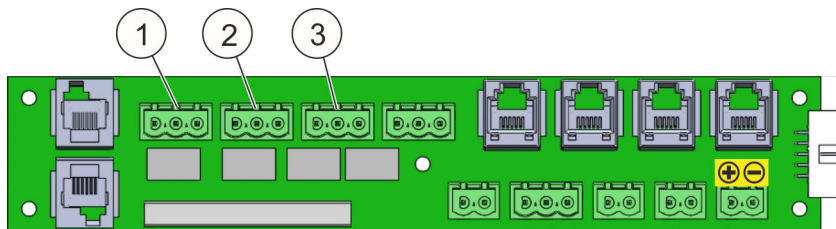

Fig. 19: Potential-free contacts

INFORMATION

Make sure, at an early stage, that the cabinet to be protected meets all of the requirements in regard to space needs, tightness and mounting options, so that the system can be installed in a proper functional manner.

INFORMATION

Be sure to keep the packaging the system came in. The system can only be sent for maintenance or repair in the special original packaging it came in or in packaging equivalent to this.

6.2.1 Installation instructions

⚠ WARNING

Danger due to faulty installation!

Non-horizontal installation of the system results in the extinguishing agent not being fully discharged and the failure message “*Extinguishing agent loss*” being displayed.

- Mount the system in a horizontal position (using a spirit level for alignment).

⚠ WARNING

Danger due to the installation of the system in unsuitable control cabinets!

If the system is installed in unenclosed control cabinets (e.g. due to a lack of doors or side panels), there may be an uncontrolled spread of smoke and fire, fires may not be detected, extinguishing agent may be spread in an uncontrolled way, and fires may not be extinguished. This can cause serious injury and substantial property damage.

- Use the system only in enclosed control cabinets.
-

⚠ CAUTION

Risk of injury due to improper installation!

Improper installation can cause injuries and significant property damage.

- Refrain from all tasks which generate smoke and dust (smoking, soldering, cleaning work, etc.) during installation and commissioning of the system.
-

NOTICE

Property damage from alarm release!

The alarm can be released during installation/commissioning.

- Shut down downstream controllers (e.g. further extinguishing systems or transmissions) prior to installation/commissioning.
-

The system is to be placed in the upper third of the 19" cabinet to be protected. In this case, it is to be observed that

- the suction pipe with suction bores is installed as described in ↪ *Chapter 6.2.5 "Suction pipe installation instructions" on page 43.*
- the positioning of the suction pipes is dependent on the direction of the air flow. If the suction pipes are installed horizontally, the positioning is to undergo a smoke response test ↪ *Chapter 6.2.8.4 "Fire detectors" on page 50.*
- the nozzle is placed in such a way that, with the exception of the cabinet wall, there are no further spray obstacles (e.g. wires) within a 200 mm radius of the nozzle. This must also be considered in regard to any subsequent changes in the cabinet.

6.2.2 Installation steps and functional test

⚠ CAUTION

Risk of injury due to incorrect methods!

Deviating from the following installation steps can cause injuries and significant property damage.

- Adhere to the sequence of installation steps described here under all circumstances.
-

1. ➤ Remove the system from the packaging, place it on a stable base, and check it for completeness and damage.
2. ➤ Check the temperature indicator for an increase in temperature ↪ *Chapter 6.2.3 "Temperature indicator" on page 42.*



Fig. 20: Blocking switch

3. ➤ Blocking the system: Switch the blocking switch (Fig. 20/arrow) to "Agent disconnect [blocked]" (Fig. 20/II).
4. ➤ Unscrew the front enclosure cover and disconnect the grounding cable.
5. ➤ Connect the batteries.
6. ➤ Refit the grounding cable and front enclosure cover.



Fig. 21: Battery button

7. ➤ Activate the system using the battery button (Fig. 21) (Battery ON).

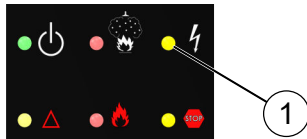

Fig. 22: "Failure" LED

8. ➤ Check whether the "Failure" LED (Fig. 22/1) lights up and the display shows "Failure tank triggering".
9. ➤ When using door contact switches, configure the settings ↪ *Chapter 6.3.5 "Door contact / blocking" on page 55.*
10. ➤ When using additional extinguishing units (DET-AC III Slave), configure the settings ↪ *Chapter 6.3.6 "Combination of systems" on page 58.*
11. ➤ Deactivate the system using the battery button (Fig. 21) (Battery OFF).

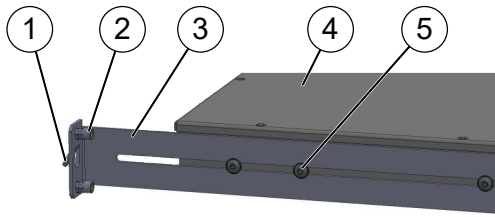

Fig. 23: Assembling the rails

12. ▶ Attach the right and left rails (Fig. 23/3) on the side of the system (Fig. 23/4) using the supplied screws (M4, Fig. 23/5).
 - ⓘ Do not tighten the screws yet.
13. ▶ Attach the system in the rear area of the cabinet using the hook (Fig. 23/1) on the rails.
14. ▶ Slide the system in horizontally up to the stop of the front panel.
15. ▶ Align the system horizontally using a spirit level.
16. ▶ Fasten the system to the front panel in the 19" frame using the supplied screws (M6) and the black plastic washers.
 - ⓘ The mounting holes are located on the right and left of the outer side of the front plate.
17. ▶ Tighten the screws (Fig. 23/5).
18. ▶ Mount the rear rails on the cabinet using the supplied screws (M5). Nuts for doing so are provided in the rails (Fig. 23/2).
19. ▶ Install the suction pipe ↪ Chapter 6.2.5 "Suction pipe installation instructions" on page 43.
20. ▶ To start up the system, press the "Battery ON" button (Fig. 21).
21. ▶ Connect the mains power supply.
 - ⓘ If a mains power supply is unavailable, shut down the system again using the "Battery OFF" (Fig. 21) following installation to prevent the batteries from discharging.
22. ▶ Connect the door contact switches ↪ Chapter 6.3.5 "Door contact / blocking" on page 55.
23. ▶ Set the air flow monitoring ↪ Chapter 8.6 "Air flow calibration" on page 73.
24. ▶ Connect the alarm elements (optional) ↪ Chapter 6.3.2 "External alarm devices" on page 53.
25. ▶ Connect the Rittal CMC, IoT interface or Power Distribution Unit PDU (optional) ↪ Chapter 6.3.3 "Monitoring system" on page 54.
26. ▶ Engage the floating contacts (optional) ↪ Chapter 6.3.1 "Potential-free contacts" on page 52.
27. ▶ Set the air flow calibration ↪ Chapter 8.6 "Air flow calibration" on page 73.
28. ▶ Import the set parameters through the maintenance program ↪ Chapter 10.3 "Project" on page 94.

- 29. ▶ Check the fault and alarm functions ↪ *Chapter 6.2.8 "Checking the failure and alarm function" on page 48.*
- 30. ▶ Perform a smoke reaction test ↪ *Chapter 6.2.8.4 "Fire detectors" on page 50.*
- 31. ▶ Following the reaction test, wait at least two minutes for the concentration of test gas in the fire detectors to fall.

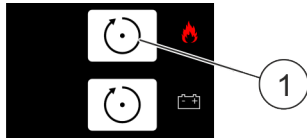

Fig. 24: [Reset] button

- 32. ▶ Reset the alarm with the upper [Reset] button (Fig. 24/1).

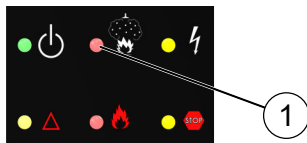

Fig. 25: "Extinguishing system triggered" LED

- 33. ▶ Check that the "Extinguishing system triggered" LED (Fig. 25/1) is not illuminated.

- 34. ▶ **⚠ WARNING! Risk of faulty release!**

Activating the system: Switch the blocking switch (Fig. 20/arrow) to "Agent connect [not blocked]" (Fig. 20/I).

⇒ The system is ready for operation and activation!



Fig. 26: Warning sign

- 35. ▶ Attach the "Gas-based extinguishing system – Danger to health!" sign (Fig. 26) in a clearly legible position on the cabinet.

i You should preferably attach the warning signs to the outside of the cabinet doors. Alternatively, you can also attach the warning signs on a side wall if they will draw more attention there.

Connecting additional devices ↪ *Chapter 6.3 "Installation and commissioning of additional electrical devices" on page 51.*

6.2.3 Temperature indicator

i The temperature indicator (65 °C (149 °F)) is on the front cover.

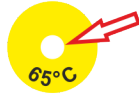

Fig. 27: Temperature indicator light: Temperature is okay.

1. Check that the temperature indicator is in a proper state (Fig. 27).

i If the temperature indicator is dark (Fig. 28), it is possible that electrical components have been damaged or that the tank has a leak due to the increased pressure caused by an increased temperature.

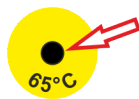
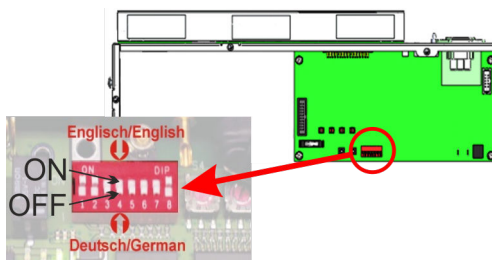

Fig. 28: Temperature indicator dark: **Notice**, the temperature was exceeded!

2. Contact the Authorized Distributor if the temperature indicator is dark in color and have the system replaced.

6.2.4 Language setting for display and operation



The system can communicate in "German" and "English". "German" is pre-set by the manufacturer but can be changed to "English" via a DIP switch (Fig. 29). Proceed as follows to make the changeover:

Fig. 29: Language setting

1. To block the system: Switch the blocking switch (Fig. 30/arrow) to "Agent disconnect [blocked]" (Fig. 30/II).
2. Disconnect the system from the mains supply and the emergency power batteries.
3. Peel off the transparent protective film.
4. Switch the DIP switch "4" from position "OFF" (German) to "ON" (English).
5. Stick the protective film on again.
6. Put the system in service again.



Fig. 30: Blocking switch

6.2.5 Suction pipe installation instructions



Malfunction due to covered suction bores!

If any cables are covering the suction bores the smoke suction pipe system, fires may not be detected and extinguished in good time. Any malfunction results in a risk of injury and substantial property damage.

- Always discuss the installation of the system with the operator.
- If you subsequently fit cables in the protected cabinet, always ensure that the suction bores remain unobstructed.

INFORMATION

The suction pipe system is a self-sealing and self-locking pipework system. The pipe connection is fully established by connecting the pipe and fitting.



Fig. 31: Suction pipe

1. ➤ Mount the vertical suction pipe (Fig. 31) in the cabinet at a point that is suitable for the fluidic system using the clamps.

***i** The suction bores must not be covered by the clamps or other add-on parts.*

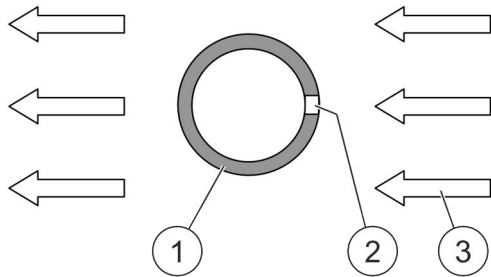

Fig. 32: Suction pipe and air flow

2. ➔ Align the suction pipe (Fig. 32/1) with the suction bores (Fig. 32/2) so that the suction bores are directed against the air flow (Fig. 32/3) (e.g. from air-conditioning devices or fans).

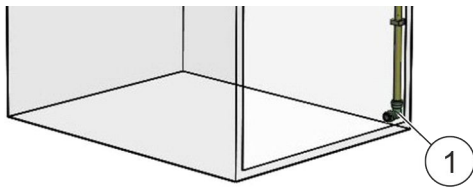

Fig. 33: Elbow and plug

3. ➔ Fit an elbow at the end of the suction pipe in the bottom area of the cabinet and close the elbow with a plug (Fig. 33/1).
4. ➔ **⚠ CAUTION! Risk of faulty release!**
Block the system before performing any checks ↪ Chapter 6.2.8.4 “Fire detectors” on page 50.
5. ➔ **⚠ CAUTION! Malfunction due to incorrectly installed suction pipe!**
Perform a reaction test with a test aerosol.
6. ➔ **⚠ CAUTION! Faulty release due to the removal of the blocking!**
Remove the system block only if no red LEDs are lit up and there is no fire alarm on the display.

6.2.5.1 Establishing the suction bores

⚠ CAUTION

Risk of injury due to incorrect detection!

Incorrectly produced suction bores may result in incorrect detection. This can cause serious injury and substantial property damage.

- Comply with the specifications listed below for establishing the suction bores.

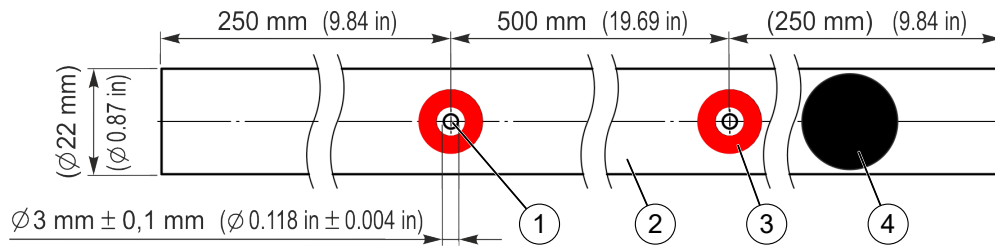

Fig. 34: Suction pipe

1. ▶ Drill suction bores (Fig. 34/1) into the suction pipes (Fig. 34/2). Carry out distances and bore diameters according to Fig. 34.

i The number of suction bores depends on the number of monitored cabinets. Observe the following specifications:

- 1 cabinet: 4 suction bores
- 2 cabinets: $2 \times 4 = 8$ suction bores
- 3 cabinets: $3 \times 4 = 12$ suction bores
- 4 cabinets: $4 \times 3 = 12$ suction bores
- 5 cabinets: $5 \times 3 = 15$ suction bores

2. ▶ Deburr suction bores.
3. ▶ Degrease areas for red bore marks (Fig. 34/3) on suction pipes.

i Cleaning agents that attack plastics must not be used under any circumstances.

4. ▶ Glue the red bore marks³⁾ into place, making sure they are in the middle of the suction bores.
5. ▶ If there are too many suction bores:

- Degrease the area around the bore to be sealed.

i Cleaning agents that attack plastics must not be used under any circumstances.

- Glue the black sticker³⁾ (Fig. 34/4) into place, making sure it is in the middle of the redundant bore.

³⁾ Included in the scope of delivery of the suction pipe system (part no. 907061).

6.2.5.2 Mounting the suction pipe

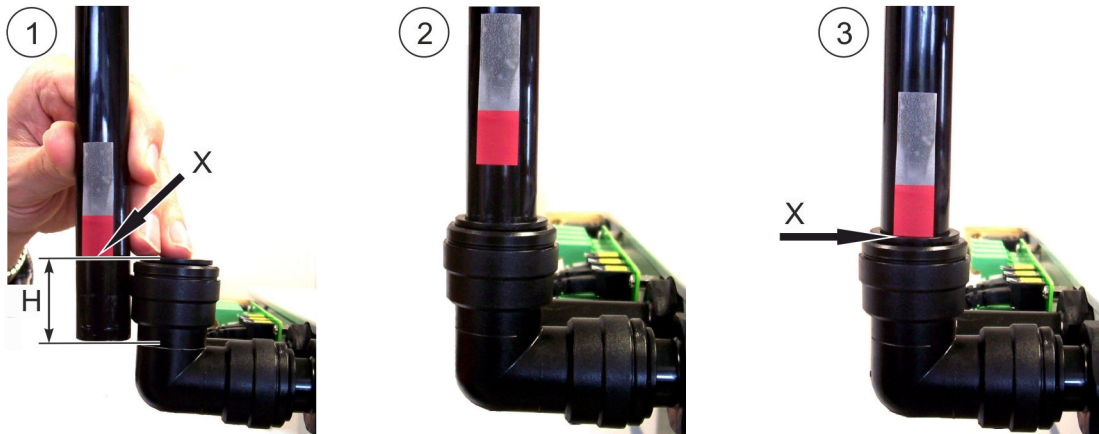

Fig. 35: Mounting

1. [Fig. 35/1]: Mark the insertion depth (Fig. 35/H) of the pipe (Fig. 35/X). Use the auxiliary line at the pipe angle. Insertion depth (H) approx. 33 mm.
2. [Fig. 35/2]: Loosely insert the pipe.
3. [Fig. 35/3]: Push in the pipe up to the marking (Fig. 35/X) and until it can be heard and felt to be in the stop.

6.2.5.3 Disassembling the suction pipe

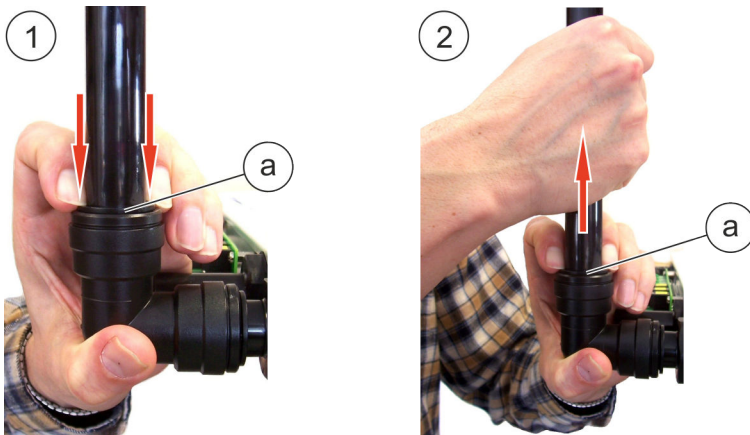
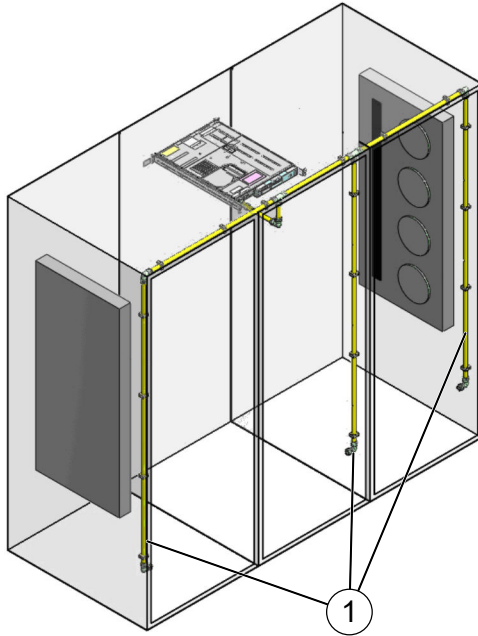

Fig. 36: Dismantling

1. [Fig. 36/1]: Press down the retaining element (Fig. 36/a). The retaining element is only recognizable as a ring from the outside.
2. [Fig. 36/2]: Pull out the pipe when the retaining element is pushed down (Fig. 36/a).

6.2.5.4 Installation of the system and suction pipes when monitoring several 19" cabinets



The system can protect a nominal fill of 2.8 m³ (98,9 ft³). If this nominal fill is distributed across several 19" cabinets, then the suction pipelines (Fig. 37/1) are to be installed in each 19" cabinet in order to ensure rapid detection.

When monitoring more than two 19" cabinets, the superordinate system itself should be placed in a middle 19" cabinet so two pipeline paths arise which are as identical as possible and fluidically convenient. The total length of the pipeline must not exceed 20 m (66 ft).

When using one system to monitor several 19" cabinets, the 19" cabinets must not be separated by partition walls.

Fig. 37: Monitoring several 19" cabinets

6.2.6 Instructions for the use of the DET-AC III Master system with simultaneous use of an automatic door opening "ADO"

19" cabinets can be equipped with an automatic door opening "ADO". In the case of an automatic door opening "ADO", there are flaps in the door of the 19" cabinet. The flaps are opened automatically, e.g. if the cooling system in the 19" cabinet fails.

⚠ CAUTION

Unwanted release due to absent blocking!

If the active extinguishing system DET-AC III Master is used in 19" cabinets with an automatic door opening "ADO" from Rittal and no flap is monitored, the system is not blocked when a flap is open. The system can however be released in the event of detection.

- In addition to the monitoring of the door, install at least on one flap of the automatic door opening "ADO" a monitoring with a door contact switch (type 7030.128).

Installation of the door contact switch ↪ *Chapter 6.3.5.1 "RJ12 plug" door contact switch* on page 56.

Assembly of the door contact switch and operation of the flaps: see documentation from the manufacturer of the automatic door opening "ADO".

6.2.7 Setting air flow calibration

How to set the air flow calibration is described in [Chapter 8.6 “Air flow calibration” on page 73](#).

10% is to be set as the permissible deviation from the total measured air flow, as contamination of the suction holes is recognized as early as possible at this setting. If frequent air flow failure messages appear due to flow conditions, the analysis time prior to failure evaluation should be increased first of all. As a further measure, the deviation from the actual set flow value can be raised by 20% or 40%.

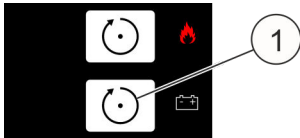

Fig. 38: [Reset PS] button

The door to the protected cabinet must be closed immediately following the start of air flow calibration. The door must not be opened again until the counter has incremented and the air flow is displayed. Now set the deviation from the actual set flow value and confirm with the button [Reset PS] (Fig. 38/1).

INFORMATION

The air flow must be recalibrated when changing the equipment of the switch cabinet.

6.2.8 Checking the failure and alarm function

The system is ready for operation when the door is closed: The green LED lights up and “State OK” is shown in the display. If this is not the case, actuate the upper [Reset] button (Fig. 39/1). The green LED then blinks twice and messages that are still pending are reset.

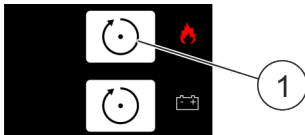

Fig. 39: [Reset] button

INFORMATION

Switch the system into the revision state for inspection [Chapter 8.10 “Revision” on page 80](#). Transmissions are blocked by this.

6.2.8.1 Air flow

By using residue-free removable insulating tape to cover up the suction holes, the extracted air flow is reduced and a blockage is simulated. The message “Failure (too low) air flow” should now appear in the display. Remove the insulating tape from the suction pipe after checking the air flow. The message “Failure (too low) air flow” is reset automatically.

By removing the suction pipe, damage (e.g. a crack) to the suction pipe is simulated. The message *“Failure (too high) air flow”* should now appear in the display. Remount the suction pipe after checking the air flow. The message *“Failure (too high) air flow”* is reset automatically.

6.2.8.2 Door contact switch

By opening a door to the protected cabinet which is equipped with a door contact switch, the message *“Blocking by door cont.”* is generated and the yellow LEDs (Fig. 40/1+3) lit up.

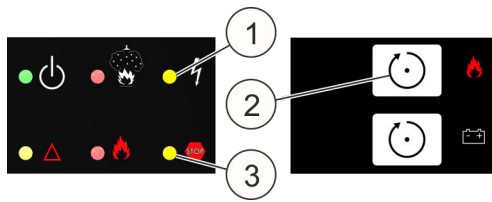

Fig. 40: LEDs and [Reset] button

By removing the door contact plug on the rear side of the system, the door contact switch is deactivated. The message *“Failure door contact”* is also shown in the display.

Remount the door contact switch and activate the system using the upper [Reset] button (Fig. 40/2).

The check must be performed for each of the door contact switches that are installed.

NOTICE

Faulty release due to removal of the blocking!

Premature removal of the blocking can result in a faulty release and thereby cause property damage.

- Do not stop blocking the system until there are no red LEDs lit up and there is no fire alarm shown in the display.

6.2.8.3 Manual call point

CAUTION

Danger of injury from faulty release!

Checking the manual call point when the system is not blocked can result in a faulty release. A faulty release may cause injuries and significant property damage.

- Block the system prior to checking the manual call point. To this end, switch the blocking switch on the back of the system to the II "Agent disconnect [blocked]" position.

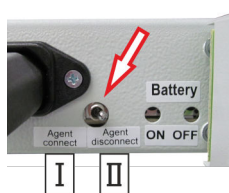
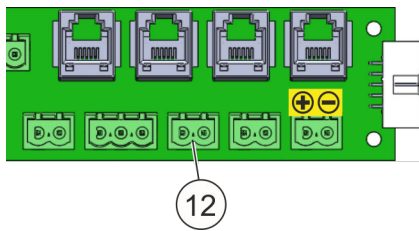

Fig. 41: Blocking switch

- I Agent connect [not blocked]
- II Agent disconnect [blocked]



Connect the manual call point as per [Chapter 6.3.7 “Manual call point”](#) on page 63 to connection "manual call point" (Fig. 42/12).

Fig. 42: Connection manual call point

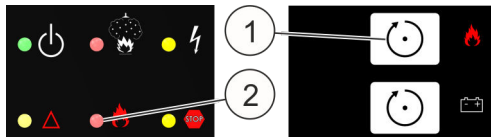

Reset the failure message that comes up when connecting with the upper *[Reset]* button (Fig. 43/1).

Fig. 43: LED and *[Reset]* button

After the manual call point is released, the lower red LED (Fig. 43/2) blinks and “Manual release” and “Fire” are shown in the display.

Reset the manual call point and activate the system again with the upper *[Reset]* button.

NOTICE

Faulty release due to removal of the blocking!

Premature removal of the blocking can result in a faulty release and thereby cause property damage.

- Do not stop blocking the system until there are no red LEDs lit up and there is no fire alarm shown in the display.

6.2.8.4 Fire detectors

CAUTION

Danger of injury from faulty release!

Checking the fire detector when the system is not blocked can result in a faulty release. A faulty release may cause injuries and significant property damage.

- Block the system prior to checking the fire detector. To this end, switch the blocking switch on the back of the system to the II "Agent disconnect [blocked]" position.
- Switch the blocking switch (Fig. 44/arrow) on the rear side of the system to "Agent disconnect [blocked]". In this way the release mechanism for the propellant cartridge is deactivated.
- Release the system using test gas ([Chapter 12 “Spare parts, accessories, consumables, and tools”](#) on page 116) at the last hole of the suction pipe (spray for approx. 2 to 4 seconds directly into the suction hole).

- The system generates the following messages in the display in the LEDs:
 - “Fire alarm detector 1”, “Pre-alarm”, LED "Extinguishing system triggered" flashes (Fig. 45/1)
 - “Fire alarm detector 2”
 - “Fire”, LED "Extinguishing system released" (Fig. 45/3)
 - “Tank not empty”
- Reset the alarm with the upper [Reset] button (Fig. 45/2) after at least 2 minutes so that the test gas can fully escape from the measuring chamber. The red LEDs go out and the alarm messages in the display are deleted.



- I Agent connect [not blocked]
- II Agent disconnect [blocked]

Fig. 44: Blocking switch

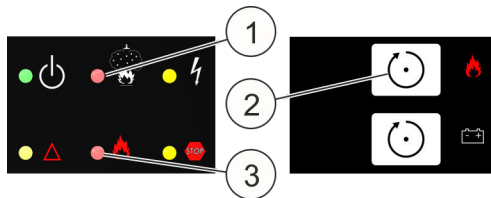

Fig. 45: LEDs and [Reset] button

NOTICE

Faulty release due to removal of the blocking!

Premature removal of the blocking can result in a faulty release and thereby cause property damage.

- Do not stop blocking the system until there are no red LEDs lit up and there is no fire alarm shown in the display.

6.3 Installation and commissioning of additional electrical devices

Personnel: Qualified electrician
 Authorized Distributor

Protective equipment: Safety goggles

Following proper installation and commissioning, additional electrical devices can be connected to the system.

NOTICE

Damage due to alarm release!

The alarm can be released during installation/start-up of an additional electrical device. This can cause significant property damage.

- Shut down external system controllers (e.g. activation of further extinguishing systems or transmissions via floating contacts) prior to connecting additional electrical devices.
- Block the system prior to the function test for additional electrical devices. To this end, switch the blocking switch to “Agent disconnect [blocked]”. The yellow “Failure” LED lights up continuously.
- Check that no alarm message (red LED “Extinguishing system triggered”) is displayed prior to removing the blocking. The extinguishing process is otherwise initiated immediately.

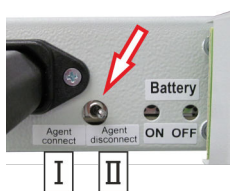

- I Agent connect [not blocked]
 - II Agent disconnect [blocked]
- 1 LED "Failure"
 - 2 LED "Extinguishing system triggered"

Fig. 46: Blocking switch

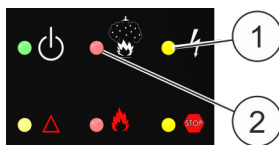

Fig. 47: LEDs

6.3.1 Potential-free contacts

NOTICE

Malfunction due to interrupted relay contacts!

When using relay contacts for external controllers, the connections to the relay contacts can be interrupted when removing the system from the protected cabinet. As a result, there is a danger of unwanted switching states arising from, e.g. safety functions, which use closed circuits via relay break contacts in normal state.

- Do not interrupt the connections to the relay contacts when removing the system from the protected cabinet.

Relay 1 Pre-alarm 1 (NO)	A fire detector has been activated. The relay remains triggered until the upper [Reset] button is actuated.	
Relay 2 Fire alarm (NO)	The second fire detector has released or a manual call point was actuated. The relay remains triggered until the upper [Reset] button is actuated.	

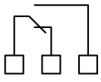
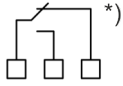
Relay 3 Extinguish (NO)	The relay is triggered at the same time as the activation of the extinguishing process and remains triggered until the upper <i>[Reset]</i> button is actuated.	
Relay 4 Common failure (NC)	The relay is triggered at the same time as the activation of the extinguishing process and remains triggered until the upper <i>[Reset]</i> button is actuated.	

*) *always closed during operation*

Relays “1” to “3” remain continuously triggered in this case. For the relays “1” to “4” the maximum switch voltage of the changeover contacts is 30 V at a maximum switching current of 0.5 A and pure ohmic load. Inductive or capacitive loads require external protective circuits and are to be provided by the operator or by the Authorized Distributor, depending on the contractual basis.

6.3.2 External alarm devices

External alarm devices such as flashlights and/or horns ( Chapter 12 “Spare parts, accessories, consumables, and tools” on page 116) can be connected to output “10” (Fig. 48/10). This output monitors the line that is connected as well as the alarm device that is connected for wire breaks and short circuits.

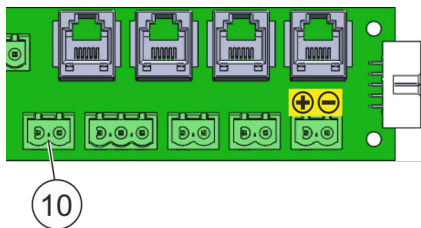

Fig. 48: Connection external alarm device

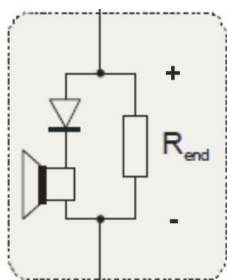



Fig. 49: Circuit diagram

When activating the output via a manual call point or via the fire alarm “detector 2”, a system voltage (21 V - 27 V) is supplied to the terminals.

Monitoring for wire breaks and short circuits occurs with a low voltage to control reverse polarity. To this end, the alarm device must be connected as per Fig. 49 with one terminating resistor $R_{END} = 47 \Omega$ and one diode 1N4007.

The alarm device must be measured for correct monitoring  Chapter 8.12.4 “Measuring alarm device” on page 85.

6.3.3 Monitoring system

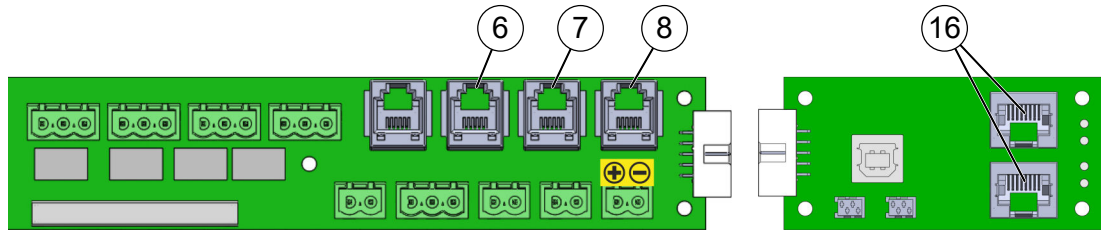

Fig. 50: CMC connections

- 6 Plug (RJ12) for connection to Rittal Monitoring System CMC-TC („*failure*”)
- 7 Plug (RJ12) for connection to Rittal Monitoring System CMC-TC („*fire alarm*”)
- 8 Plug (RJ12) for connection to Rittal Monitoring System CMC-TC („*pre-alarm*”)
- 16 CAN bus interface (RJ45) for connection to various Rittal Monitoring Systems (CMC, IoT interface, PDU)

The Computer Multi Control (CMC) is an alarm system for control, network and server cabinets. It monitors temperatures, humidity, inflow, smoke, energy and many other physical environmental parameters. The CMC III has a CAN bus interface to which various CAN bus sensors can be connected. The system can be addressed via the network using a standard browser as well as with the most common network protocols.

As an alternative to the Rittal CMC, the Rittal IoT interface or various PDUs can also perform these functions.

The system DET-AC III Master also has two CAN bus interfaces (Fig. 50/16) through which the system can be connected directly to various monitoring systems from Rittal (CMC, IoT interface, PDU) ↪ *Chapter 5.3.3 “Interfaces to the Monitoring System” on page 32.*

The CMC-TC is the predecessor to the CMC III and does **not** have a CAN bus interface. The three states “*Failure*” (Fig. 50/6), “*Fire alarm*” (Fig. 50/7) and “*Pre-alarm*” (Fig. 50/8) can be queried via the RJ12 connectors (Fig. 50) using a CMC-TC I/O Unit.

6.3.4 External fill level monitoring and external tank

The option of external fill level monitoring and selection of an external tank exists only for the aspirating smoke detection system EFD III. The aspirating smoke detection system EFD III provides the option of triggering an external extinguishing agent container in the event of a fire. Moreover, the extinguishing agent fill level of the external extinguishing agent container can be monitored with the aspirating smoke detection system EFD III.

6.3.5 Door contact / blocking

Door contact switches for monitoring the door position (open/closed) of the protected cabinet are connected to the connection "Door contact". If the door contact switch is actuated by opening the door, the extinguishing control of the whole system blocks (including all systems "DET-AC III Slave"). Up to 10 door contact switches can be connected per system. The lines between the door contact switches and the system are monitored for breaks and short circuits.

⚠ WARNING

Danger due to unwanted blocking!

The connection of door contact switches to connection "5" and at the same time to connection "13" causes the system to be blocked even when the doors are closed.

- Connect door contact switches only to connection "5" **or** to connection "13".

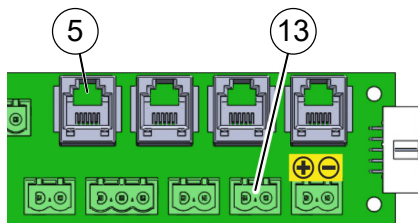

Fig. 51: Connections door contact switch

⚠ CAUTION

Unwanted release due to absent blocking!

If no door contact switches are used, the system is not blocked when the door is opened. The system can however be released in the event of detection.

- If there are no door contact switches, inform all persons who are working on the control cabinet of a possible release of the system if the door is open.

⚠ CAUTION

Danger to life if system is not operational!

Fire messages from the fire detectors and the manual call point which occur during the state "Extinguishing system blocked" (= blocking of the extinguishing system), generate the state and the message "Extinguishing system activated". In blocked state, this does not however lead to extinguishing.

- Start up the system again as quickly as possible (e.g. close the door(s) and keep them closed).

⚠ CAUTION

Danger of injury due to escaping extinguishing agent!

If, when the system is blocked (display “*Extinguishing system blocked*”), a fire alarm is released and blocking is removed when there is an alarm by, for example, closing the door, the extinguishing process is released one second after blocking is removed.

- Do not stop blocking the system until there are no red LEDs lit up and there is no fire alarm shown in the display.

6.3.5.1 "RJ12 plug" door contact switch

Door contact input "5" (Fig. 52/5) is designed for the *Rittal* "RJ12 plug" door contact switch (Fig. 53/2).

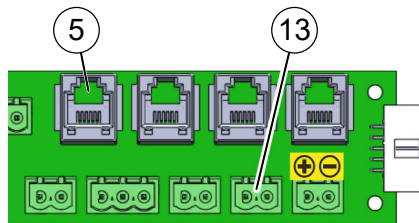

Fig. 52: Connections for door contact switches

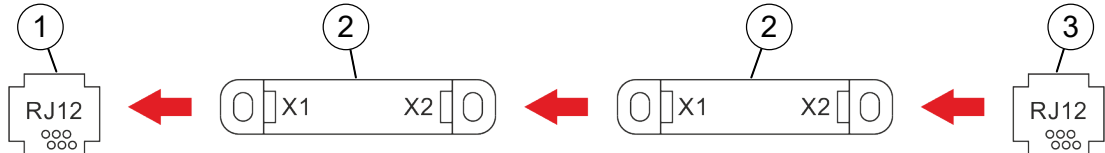

Fig. 53: Installation diagram

- 1 Door contact input "5" (Fig. 52/5)
- 2 "RJ12 plug" door contact switch (access sensor)
 - X1 RJ12 bushing (6-pin) for connecting to the system or for series connection with an additional door contact switch
 - X2 RJ12 bushing (6-pin) for series connection with additional door contact switches (maximum of 10 switches) or for the "terminating resistor" RJ12 plug
- 3 "Terminating resistor" RJ12 plug



Fig. 54: End-of-line resistor and door contact switch

1. ➤ Connect the "RJ12 plug" door contact switch (Fig. 53/2) to door contact input "5" (Fig. 52/5) as per Fig. 53.

i The overall length of the RJ12 connecting cable used (0.14 mm² (AWG 26)) must be a maximum of 30 m (98 ft).

2. ➤ Connect the "Terminating resistor" RJ12 plug (Fig. 53/3 or Fig. 54/1).

i If there are any older, gray door contact switches (type 7320.530, Fig. 54/4), note that a different end-of-line resistor from the one for the transparent door contact switches is required:

Door contact switch	End-of-line resistor
Type 7030.128 , transparent (Fig. 54/2)	1 kΩ
Type 7320.530 , transparent (Fig. 54/3)	1 kΩ
Type 7320.530 , gray (Fig. 54/4)	22 kΩ

3. ➤ Remove the pre-fitted end-of-line resistor (Fig. 52/13) when using the "RJ12 plug" door contact switch.

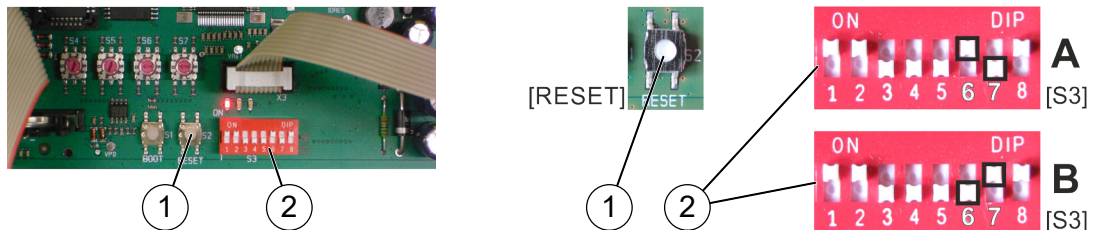

Fig. 55: [Reset] button and DIP switch "S3"

A Setting for the transparent door contact switch

B Setting for the gray door contact switch

4. ➤ On the CPU3 control card on DIP switch "S3" (Fig. 55/2), set slide buttons "6" and "7" according to the switch type (transparent/gray):

Door contact switch	Slide button	
	"6"	"7"
Type 7030.128 , transparent (Fig. 54/2)	"ON"	"OFF"
Type 7320.530 , transparent (Fig. 54/3)	"ON"	"OFF"
Type 7320.530 , gray (Fig. 54/4)	"OFF"	"ON"

5. ➤ Restart the system by pressing the [Reset] button (Fig. 55/1).

INFORMATION

For 19" cabinets with automatic door opening "ADO", also observe the installation instructions for this ↪ Chapter 6.2.6 "Instructions for the use of the DET-AC III Master system with simultaneous use of an automatic door opening "ADO"" on page 47.

6.3.6 Combination of systems

When combining systems DET-AC III Master (Part No. 7338.121), DET-AC III Slave (Part No. 7338.321) and EFD III (Part No. 7338.221) to protect several switch cabinets, different settings must be made to the systems.

To this end, observe the operating instruction DET-AC III Slave and EFD III as well.

6.3.6.1 Compatibility of systems from different series

Systems DET AC Plus Slave of the old series (Part No. 7338.320) can as a general rule be connected to active extinguishing systems DET-AC III Master of the new series (Part No. 7338.121). In the same way, systems DET-AC III Slave of the new series (Part No. 7338.321) can as a general rule be connected to active extinguishing systems DET AC Plus Master of the old series (Part No. 7338.120).

The systems are fully functional. However, not all messages are transmitted and certain functions cannot be performed (e.g. Maintenance Program, external tank, ...).

6.3.6.2 Networking systems

Up to five systems (active extinguishing system DET-AC III Master or EFD III with DET-AC III Slave) can be networked with each other via a bus system to protect several switch cabinets. One data line and one supply line respectively must be laid for networking ↪ Chapter 6.3.6.4 "Connecting the energy supply and data line" on page 61.

Example combinations (max. structure)

	Z2	Z3	Z4	Z5
--	----	----	----	----

Example 1:

[DET-AC III Master]	[DET-AC III Slave]	[DET-AC III Slave]	[DET-AC III Slave]	[DET-AC III Slave]
Master	Slave	Slave	Slave	Slave

Example 2:

[EFD III]	[DET-AC III Slave]	[DET-AC III Slave]	[DET-AC III Slave]	[DET-AC III Slave]
Master	Slave	Slave	Slave	Slave

Example 3:

[DET-AC III Master]	[DET-AC III Master]	[DET-AC III Master]	[DET-AC III Master]	[DET-AC III Master]
Master	Master	Master	Master	Master

Should a failure occur in the systems that are connected, the system is denoted by "Z2", "Z3", "Z4" or "Z5" in the display in the Master.

6.3.6.3 Configuring systems



Fig. 56: Blocking switch

1. To block the system: Switch the blocking switch (Fig. 56/arrow) to "Agent disconnect [blocked]" (Fig. 56/II).
2. Remove the transparent protective film in the rear section of the cover.
3. **⚠ WARNING! Danger due to malfunction!**
 - Do **not** change S4!
 - Do **not** change S5!

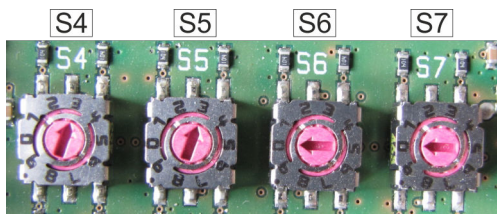





Fig. 57: Configuration

4.  Configure the system with addresses (Fig. 57).
 - Set S6 to the sum of the systems that are networked ( Table 2 "Addressing S6 and S7" on page 61).
 - Set S7 to the identification that the system has within the networking ( Table 2 "Addressing S6 and S7" on page 61). S7 must be set to "0" for non-networked systems.
5.  Close the transparent protective film in the rear section of the cover.

Combination	Master	1. DET-AC III Slave	2. DET-AC III Slave	3. DET-AC III Slave	4. DET-AC III Slave
DET-AC III Master or EFD III, not networked	 0 0	X	X	X	X
DET-AC III Master or EFD III combined with 1 x DET-AC III Slave	 2 1	 2 2	X	X	X
DET-AC III Master or EFD III combined with 2 x DET-AC III Slave	 3 1	 3 2	 3 3	X	X
DET-AC III Master or EFD III combined with 3 x DET-AC III Slave	 4 1	 4 2	 4 3	 4 4	X
DET-AC III Master or EFD III combined with 4 x DET-AC III Slave	 5 1	 5 2	 5 3	 5 4	 5 5

Tab. 2: Addressing S6 and S7

6.3.6.4 Connecting the energy supply and data line

1. ➤ Connect the mains supply (Fig. 58/2) of 100 – 240 V/AC to the Master (Fig. 58/1).
2. ➤ Establish the power supply (Fig. 58/5) between Master and first Slave (Fig. 58/7). See also ↪ Chapter 5.3.7 “Power supply” on page 34.
3. ➤ Establish the power supply (Fig. 58/6) between first Slave and next Slave (Fig. 58/8).
4. ➤ Ensure that there is no fire message pending at the Master.
5. ➤ Connect the *CAN bus connecting cable (Master/Slave)* (Fig. 58/3) between Master and first Slave.

6. → Connect the *CAN bus connecting cable (Master/Slave)* (Fig. 58/4) between first Slave and next Slave.

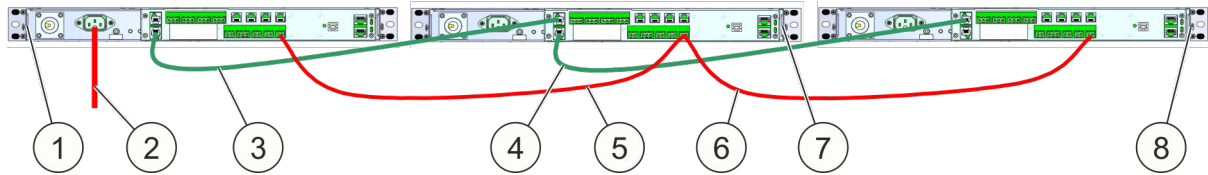

Fig. 58: Energy supply and data line

6.3.6.5 Checking networking

After complete construction of the network, a failure message must be generated on each of the systems that are networked in order to check data transmission. This is displayed at the Master if functioning correctly.

For networked systems, a failure message can, for example, be generated by actuating the blocking switch.



Faulty release due to activated system!

Checking networking using the blocking switch can result in a faulty release and thereby cause injuries and property damage.

- Only use the blocking switch to check networking if there are no red LEDs lit up and there is no fire alarm shown in the display.

6.3.6.6 Reading out the state of the respective systems

The display for the current state of the system is at the Master (active extinguishing system DET-AC III Master or EFD III). The messages of the networked devices with the identification “Z2” to “Z5” are shown on the Master display.

Identification	System to which the message relates
	Active extinguishing system DET-AC III Master or EFD III (always Master!)
Z2	DET-AC III Slave extinguishing system 1
Z3	DET-AC III Slave extinguishing system 2
Z4	DET-AC III Slave extinguishing system 3
Z5	DET-AC III Slave extinguishing system 4

6.3.7 Manual call point

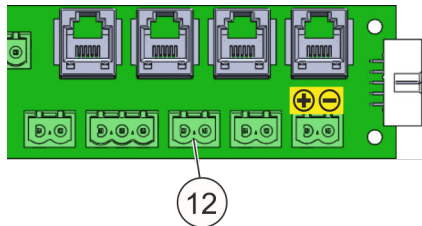

Fig. 59: Connecting terminal "Manual call point"

Manual call points are connected to the connecting terminal "Manual call point" (Fig. 59/12). If a manual call point is actuated, the extinguishing process is released.

Normal state = switch open
 Manual call point actuated = switch closed

- 1 Lines to the system (connection "12")
- 2 Resistance $R_K = 470 \Omega$, 1/10 Watt
- 3 Resistance $R_A = 1,8 \text{ k}\Omega$, 1/10 Watt (delivered as such)

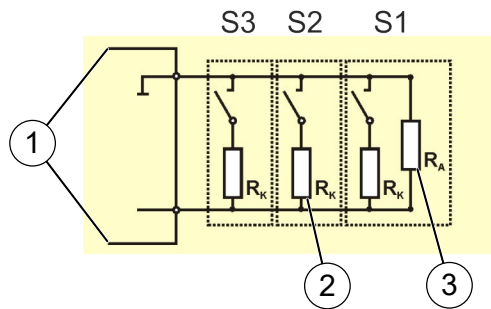

Fig. 60: Manual call points parallel connected

Several manual call points can be parallel connected (Fig. 60).

Extinguishing can be released by actuating a manual call point (☞ *Chapter 12 "Spare parts, accessories, consumables, and tools" on page 116*). Release occurs directly after the actuation and independently of the state of the automated fire detectors.

Release of extinguishing by actuating a manual call point is suppressed if blocking is in place.

The alarm message of the manual release must be reset manually using the upper [Reset] button (Fig. 61/1).

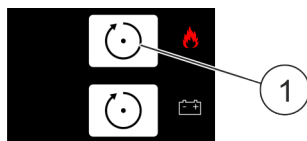

Fig. 61: [Reset] button

7 Alarms and failures

- Personnel: ■ Person in charge of the system
 Protective equipment: ■ Protective goggles



Fig. 62: DET-AC III Master

The system's operating state is signaled by the continuous green illumination in the operating LED.

The fire alarm and triggering of the system are shown on the display and through both of the red LEDs.

Failure, blocking and shutdown are shown through the yellow LEDs. If possible, the system should be installed so that it is easily visible.

Alarm messages

The system has two fire detectors with differing sensitivity to smoke. The states "Pre-alarm" and "Fire" are generated at the system.

Failure messages

The system monitors the most important functions. Failures are shown and can be transmitted via the potential-free contacts to an external display or controller.

INFORMATION

The significance of the LEDs is explained in ↗ Chapter 8.1 "LED displays" on page 67.

The display messages are explained in ↗ Chapter 9 "Messages display" on page 88.

NOTICE

Malfunction due to failure!

Correct functioning of the system is not ensured if a failure exists. Under certain circumstances, no fire can be detected or extinguished if a failure message occurs.

- Rectify the cause of the failure message immediately.

NOTICE**Faulty release due to function test!**

A function test can result in a faulty release and thereby cause property damage.

- Block the system prior to a function test. To this end, switch the blocking switch (Fig. 63/4) to "Agent disconnect [blocked]" (Fig. 63/II).
- Checking the blocked state:
 - The upper yellow LED (Fig. 63/2) lights up.
The lower yellow LED (Fig. 63/3) also lights up if a door fitted with a door contact switch is open.
 - "Failure tank triggering" is shown in the display.
- Prior to removing the blocking, make sure that the upper red LED (Fig. 63/1) is **not** illuminated as the extinguishing process will otherwise be initiated immediately.

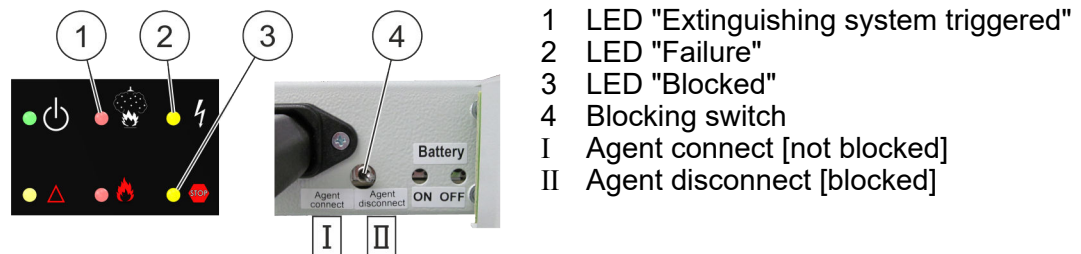

Fig. 63: Blocking

8 Display and control elements

Personnel: ■ Qualified specialist personnel

The system has one display and 6 LEDs to display the current state. It is operated by 4 buttons on the front.

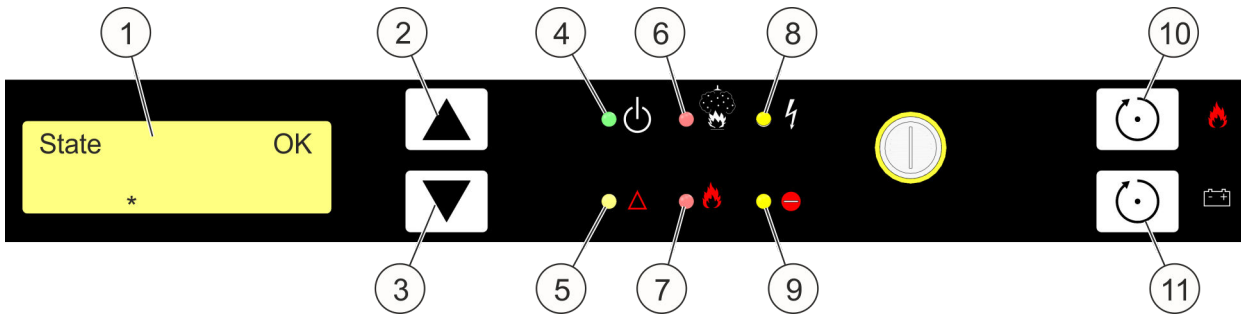

Fig. 64: Display and control elements

- | | | | |
|---|--------------------------------------|----|---|
| 1 | Display (LCD) | 7 | LED "Extinguishing system released" |
| 2 | [Up] Button | 8 | LED "Failure" |
| 3 | [Down] Button | 9 | LED "Blocked" |
| 4 | LED "Operation" | 10 | [Reset] Button |
| 5 | LED "Shutdown" | 11 | [Reset PS] Button (to reset the power supply) |
| 6 | LED "Extinguishing system triggered" | | |

8.1 LED displays

The LEDs have the following functions:

LED	Color	Function	State	Meaning
4	green	operation	off	system is without power or not ready for operation
			blinking*	access level 3 is active
			on	system is ready for operation
5	yellow	shutdown	on	there are shutdowns present
6	red	extinguishing system triggered	flashing**	one detector has released. The other one is still idle (Pre-alarm)
			on	the second fire detector has released (Fire alarm)
7	red	extinguishing system released	blinking*	the output for tank triggering was activated
			on	the discharge of the extinguishing agent was detected by the sensor at the tank within 5 seconds of triggering
8	yellow	failure	blinking*	not off in connection with the operation LED: there is a failure in the energy supply
			blinking*	off only in connection with the operation LED: outage in the central control and/or no communication between central control and control panel
			on	there is at least one failure message present (not including energy supply failure)
9	yellow	blocked	on	the triggering of extinguishing is blocked

* LED is alternating 500 ms on / 500 ms off

** LED is alternating 200 ms on / 800 ms off

8.2 Buttons

The system is operated via four buttons on the front of the system. The function of the buttons differs depending on whether the system is in “*Message display*” state (basic state) or whether the control menu is active.

Button	Function	
	in the message display	in the menus
[Up]	If there are other older messages present, they can be retrieved by actuating this button (scroll through).	Previous menu entry.
[Down]	If there are other more recent messages present, they can be retrieved by actuating this button (scroll through).	Next menu entry.
[Reset]	Deletes messages which are currently saved.	<ul style="list-style-type: none"> • Aborts the chosen function and/or exits the current menu level (ESC). • If a submenu is active, you can return to the main menu via [Reset]. • In the main menu, [Reset] effects a return to the message display (exit the control menu).
[Reset PS]	Battery failures are cancelled (in so far as they are no longer present).	<ul style="list-style-type: none"> • Activates the chosen function and/or applies the settings (Enter). • The submenu is activated if [Reset] is actuated in the main menu on an entry that refers to a submenu. • If no submenu exists, then activation of the designation control function occurs.

Tab. 3: Function of the control buttons

8.3 Display

The display serves to show, in text form, each of the current individual messages that are pending. Moreover, the text display enables menu-guided operation of the system.

8.3.1 Message display

Operating state

If there is no current message present, the message is shown in the display as per Fig. 65.



Fig. 65: Display without messages

The system's operational readiness is displayed in the lowermost line by the '*' sign. This sign runs cyclically from left to right through the image. As soon as there is a message present, the display changes automatically into the basic state of the message display.

In the state of an event, the most current pending message is shown in the display (Fig. 66).

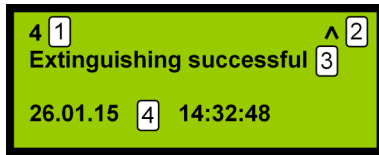

Fig. 66: Events

- 1 Number of the message = number of the currently pending messages
- 2 There are other older messages present which can be retrieved using the *[Up]* button
- 3 Message text
- 4 Date and time of the event

Scrolling through messages

If there is more than one message present, the individual messages can be seen by using the arrow buttons (*[Up]* and *[Down]*) (scroll). A symbol then appears in the message display which signals that there are still other, more recent, events present that the one currently displayed (Fig. 67).

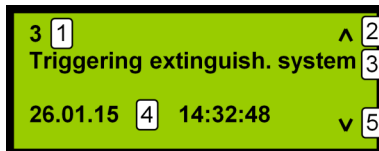

Fig. 67: Scrolling through messages

- 1 Number of this message
- 2 There are other older messages present which can be retrieved using the *[Up]* button
- 3 Message text
- 4 Date and time of the event
- 5 There are other more recent messages present which can be retrieved using the *[Down]* button

If no further input occurs in this state for 30 seconds, the display changes automatically into the basic state of the message display (display of the most recent message).

Control menus

If the control panel is in “*Message display*” state, activation of the control menu occurs through simultaneous actuation of the arrow buttons (*[Up]* and *[Down]*). As a result of this actuation, the main menu is activated and the first entry (Date / time) is displayed.

The control menu can be exited by actuating the upper *[Reset]* button (Fig. 68/1), if the main menu was active.

An activated control menu is exited automatically if no further input occurs for 30 seconds. The display then always changes automatically into the basic state of the message display.

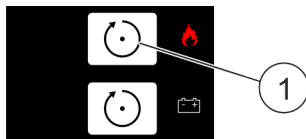
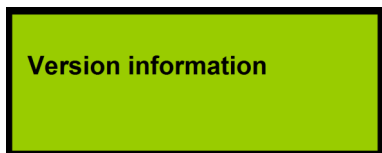
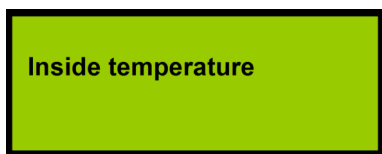
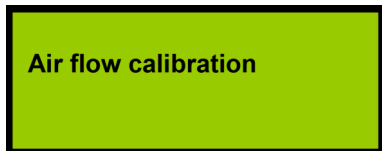

Fig. 68: *[Reset]* button

8.3.2 Main menu



Control function "Set date and time":

- Previous menu item
- Next menu item
- Exit menu
- Select function

Control function "Review the event memory":

- Previous menu item
- Next menu item
- Exit menu
- Select function

Submenu "Air flow calibration":

- Previous menu item
- Next menu item
- Exit menu
- Activate submenu

Control function "Inside temperature":

- Previous menu item
- Next menu item
- Exit menu
- Select function

Control function "Lamp test":



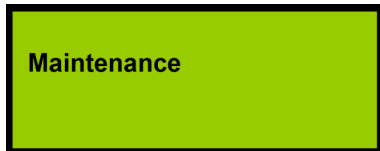

- Previous menu item
- Next menu item
- Exit menu
- Select function

Submenu "Version query":





- Previous menu item
- Next menu item
- Exit menu
- Activate submenu



Submenu "Revision":

-  Previous menu item
-  Next menu item
-  Exit menu
-  Switch on
Switch off

Control function "Maintenance":

-  Previous menu item
-  Next menu item
-  Exit menu
-  Select function

8.4 Settings and displays

Setting the date / time

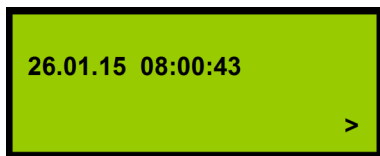



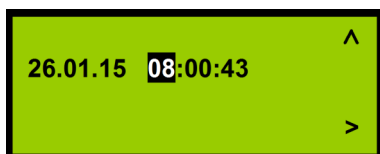

Before selecting a position:

-  Has no function
-  Select the position to be changed
-  Abort function
-  Adopt current value

The current setting is displayed after activation of the function. To be able to make a change, a current position to be changed must be selected (*[Down]* arrow button).



Changing a selected position:

-  Increment selected position
-  Select the position to be changed
-  Abort function
-  Adopt current value

The selected position can be raised by one using the *[Up]* arrow button. If the display reaches the highest value for this position, it skips to the lowest value following the next actuation of the *[Up]* arrow button. If the arrow button is pressed for longer than three seconds, the value goes up automatically. Due to the type of communication between the main processor and the control panel, there is a slight delay between actuation of the button and the reaction of the system. This means that when a button is released, which was previously held pressed, the value is raised again by roughly 2.

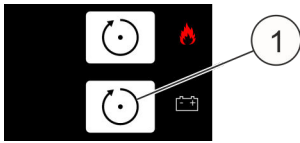

Fig. 69: [Reset PS] button

For the set values to become effective, they must be adopted ([Reset PS] button  Fig. 69/1).

8.5 Reviewing the event memory

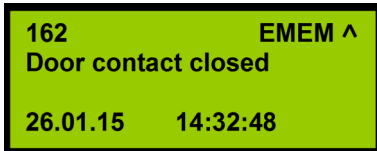



Fig. 70: Outgoing message 1

The display of messages from the event memory is identical to the system's message display. To signal that it is a display from the memory, the text "EMEM" is overlaid in the upper right section. In contrast to the message display, messages are also entered in the event memory if a state, which leads to a message, is offset again.

The representation of the outgoing message is either with a corresponding different text message (Fig. 70) or with the same message and the addition of the symbol  for the outgoing message (Fig. 71).

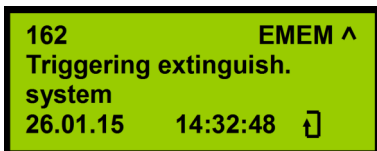

Fig. 71: Outgoing message 2

The number of the message is the number in relation to the start of the current event memory that is present. This means that the oldest event that is still in the memory has the number 1. If the event memory is full, the next event will overwrite the hitherto oldest event. In the next display of the event memory, the event which previously

has the number 2, now has the number 1 (the saved events move downward so that the new event can be added at the top). The numbering in the event memory does not in any way relate to the number that was shown for the event in the message display when the event was still current.

In the event memory display, it is possible to move from any event to the temporally oldest event by simultaneously pressing the [Up] and [Down] arrows. Similarly, the [Reset PS] button always leads to the temporally most recent event. If the respective arrow button is pressed longer when scrolling, the display proceeds automatically in the chosen direction for as long as the button remains pressed.





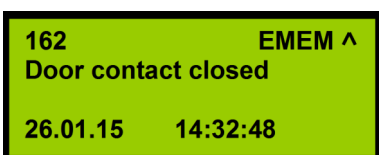

Display, if there are no entries in the event memory:

- | | | | |
|---|--------------|---|--------------|
|  | Exit display |  | Exit display |
|  | Exit display |  | Exit display |



Display of the most recent event:

- | | | | |
|---|-----------------------|---|-----------------|
|  | To previous menu item |  | Exit display |
|  | Has no function |  | Has no function |

With activation of this control function "Review the event memory", the temporally most recent message is always displayed. It is possible to change to older messages using the [Up] arrow button. The symbol \wedge in the upper right of the display shows that there are older messages present.

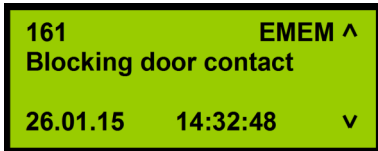

Display of an event within the memory:



To previous menu item



Exit display



To next message



To most recent message

The symbol ∇ in the lower right of the display shows that there are more recent messages present.

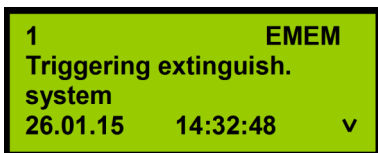

Display of the oldest saved event:



Has no function



Exit display



To next message



To most recent message

8.6 Air flow calibration

Submenu Air flow calibration

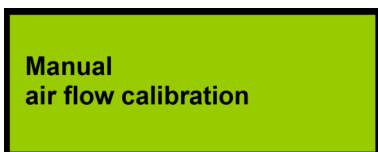
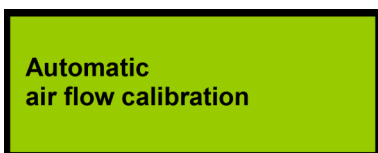
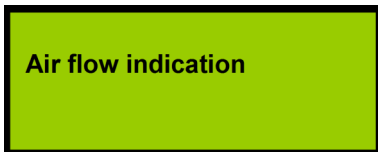

Control function "Display of the current air flow measured value":



Previous submenu item



Return to main menu



Next submenu item



Select function

Control function "Automatic calibration of the air flow monitoring":



Previous submenu item



Return to main menu



Next submenu item



Select function

Control function "Manual calibration of the air flow monitoring":



Previous submenu item



Return to main menu



- Next submenu item
- Select function

Control function "Set the integration time for the air flow monitoring":

- Previous submenu item
- Return to main menu
- Next submenu item
- Select function

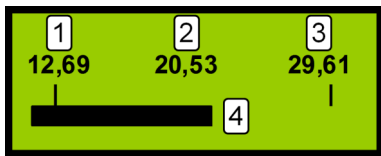

Display of the current air flow measured value:

- Has no function
- Exit display
- Has no function
- Exit display

- 1 Lower limit value of the monitoring currently set
- 2 Current measured value
- 3 Upper limit value of the monitoring currently set
- 4 Representation of the current measured value as a bar

The measured value currently present as well as the monitoring thresholds currently set are displayed. The measured value is updated cyclically so that changes to it are displayed.

8.6.1 Automatic calibration of the air flow monitoring

Determining the current values



The current values are determined. The value displayed counts up to 64 (progress bar). No further operation is possible at this stage.

Wait for this stage to be concluded.

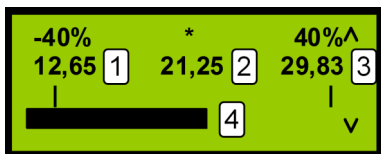

- Monitoring window bigger
- Abort function
- Monitoring window smaller
- Adopt current value

- 1 Lower limit value of the monitoring currently set
- 2 Current measured value

- 3 Upper limit value of the monitoring currently set
- 4 Representation of the current measured value as a bar

The current measured value is determined and the associated thresholds are calculated from it according to the selected width of the monitoring window ($\pm 10\%$, $\pm 20\%$ or $\pm 40\%$). 10% is to be set as the permissible deviation using the arrow buttons "Monitoring window smaller"/"Monitoring window bigger", as contamination of the suction holes is recognized as early as possible at this setting.

The standard EN 54-20 is no longer complied with at a setting greater than 20% . The deviations can be seen in the upper left and upper right side of the display.

If frequent air flow failure messages appear due to flow conditions, the time prior to the failure being displayed should be increased first of all. The tolerance can be raised by 20 or 40% as a further measure.

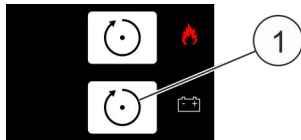

For the determined values become effective, they must be adopted ([Reset PS] button  Fig. 72/1).

Fig. 72: [Reset PS] button

8.6.2 Manual calibration of the air flow monitoring

INFORMATION

Prior to manual calibration, an automatic calibration including setting the thresholds ($\pm 10\%$, $\pm 20\%$ or $\pm 40\%$) must be performed and confirmed  Chapter 8.6.1 "Automatic calibration of the air flow monitoring" on page 74.

Determining the current values



The current values are determined. The value displayed counts up to 64 (progress bar). No further operation is possible at this stage.

Wait for this stage to be concluded.

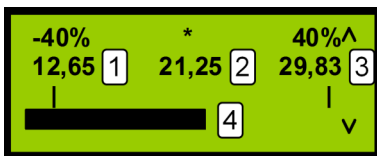

 Monitoring range upwards

 Abort function

 Monitoring range downwards

 Adopt current value

- 1 Lower limit value of the monitoring currently set
- 2 Current measured value
- 3 Upper limit value of the monitoring currently set
- 4 Representation of the current measured value as a bar

The set monitoring range is moved as a whole (lower and upper threshold simultaneously).

The set monitoring range is moved as a whole by the calculated average using the arrow buttons "Monitoring range raise"/"Monitoring range lower".

Example: See Fig. 73 and Fig. 74.

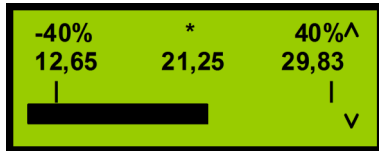

Fig. 73: Setting prior to manual calibration (example)

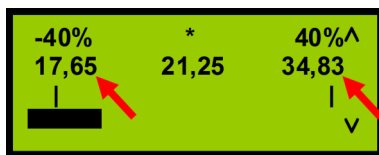

Fig. 74: Setting after manual calibration (+5)

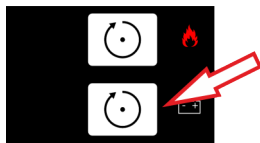

Fig. 75: [Reset PS] button

For the set values to become effective, they must be adopted ([Reset PS] button  arrow).

8.6.3 Setting the integration time for the air flow monitoring (filter time)



Increase filter time



Abort function





Decrease filter time



Adopt current value

When the system is installed in air-conditioned cabinets, it can happen that the air flow exceeds or falls below the set thresholds for a short time. An integration time (filter time) can be set in seconds in order to avoid a failure.

If an arrow button is pressed for longer than three seconds, the value goes up automatically. Due to the type of communication between the main processor and the control panel, there is a slight delay between actuation of the button and the reaction of the system. This means that when a button is released, which was previously held pressed, the value is raised or lowered again by roughly 2. It is only then that the automatic function is deactivated.

The value is set to 0 by pressing the buttons  and  at the same time.

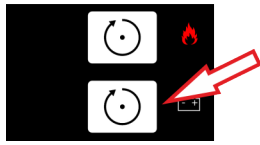

For the set values to become effective, they must be adopted ([Reset PS] button ↻ arrow).

Fig. 76: [Reset PS] button

8.7 Inside temperature

In the menu function "Inside temperature measurement", the current measured value of the inside temperature of the system is determined cyclically and is shown with the set limit values "Minimum temperature" and "Maximum temperature" ↻ Chapter 8.12.5 "Inside temperature" on page 86.

INFORMATION

If the maximum permissible temperature is exceeded or if the temperature falls below the minimum permissible temperature, a failure message results as the system may be damaged. In this case, it must be inspected by the manufacturer.

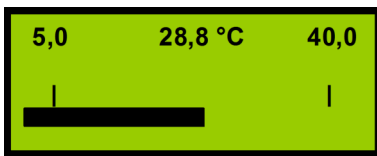

△ Has no function

Reset Exit display

▽ Has no function

Reset Exit display

8.8 Lamp test

All of the display's segments are triggered black and all of the LEDs are switched on continuously.



△ Exit test display

Reset Exit test display

▽ Exit test display

Reset Exit test display

The lamp test is exited by actuating any button. The lamp test is exited automatically if no button is actuated for longer than five seconds.

8.9 Menu "Version information"

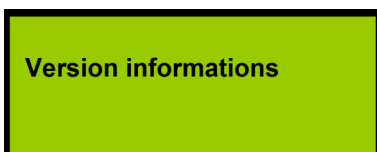

Control function "Query Firmware version":

△ Previous submenu item

Reset Return to main menu

▽ Next submenu item

Reset Select function

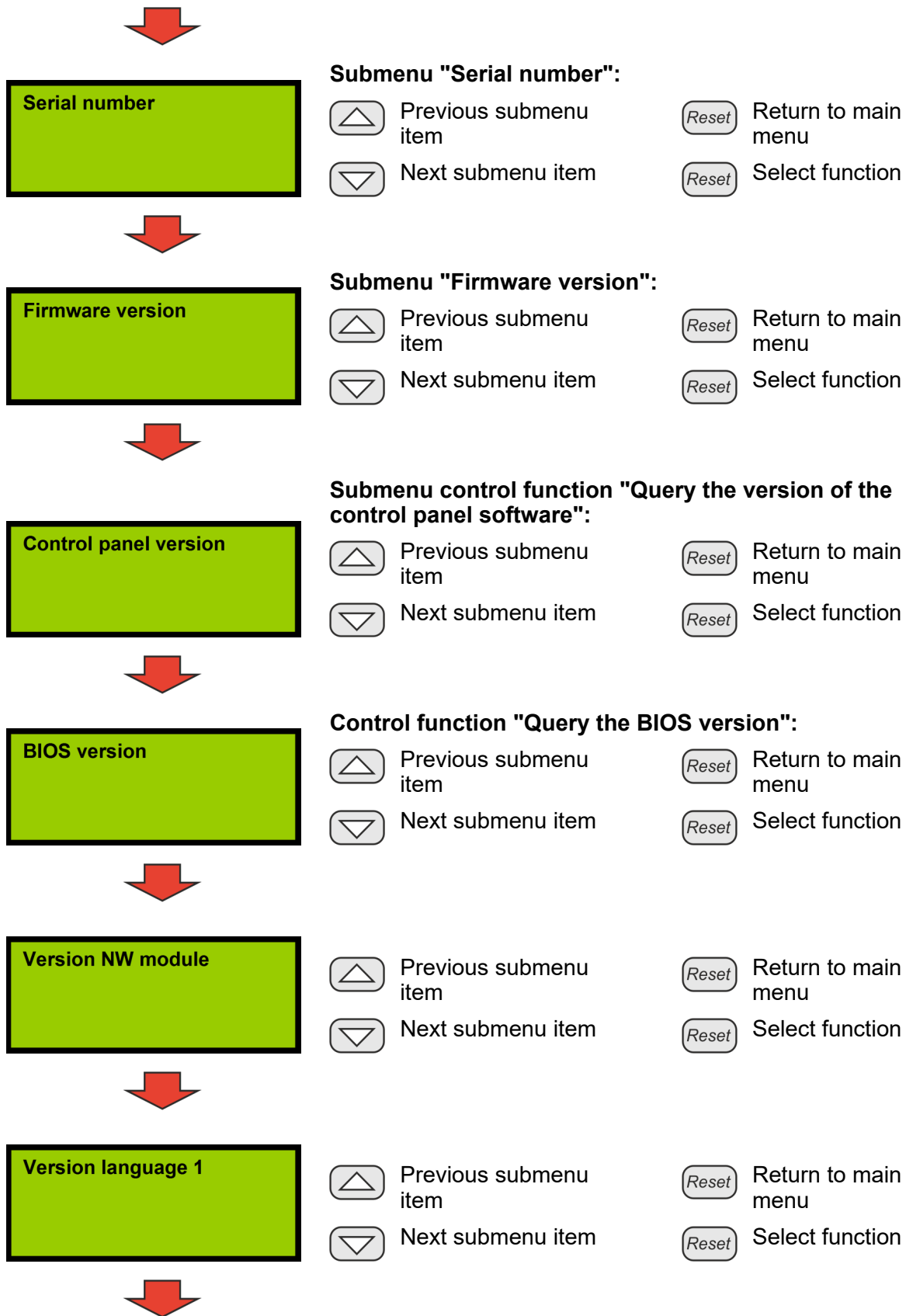

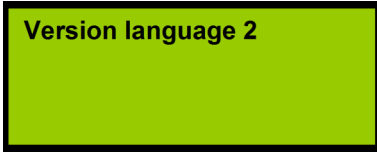

Previous submenu item



Return to main menu



Next submenu item



Select function

Description of the menu functions

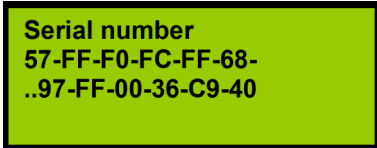

Query the serial number:



Return to menu



Return to menu



Return to menu



Return to menu

The following information is displayed: The globally unique serial number of the card for the Network Interface.



Query Firmware version:



Return to menu



Return to menu



Return to menu



Return to menu

The following information is displayed: System name, version number and the date of version creation.

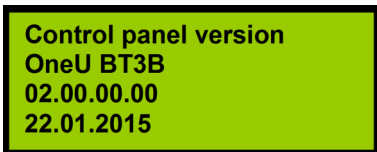

Query the version of the control panel software:



Return to menu



Return to menu



Return to menu



Return to menu

The following information is displayed: System name, version number and the date of version creation.

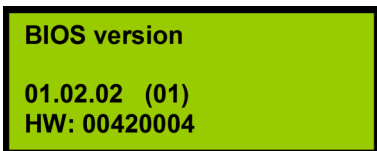

Query the BIOS version:



Return to menu



Return to menu



Return to menu



Return to menu

The following information is displayed: Version number and hardware identification.

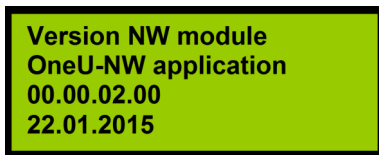

Query Version NW module:

- Return to menu
- Return to menu
- Return to menu
- Return to menu

The following information is displayed: Application name, version number and the date of version creation.

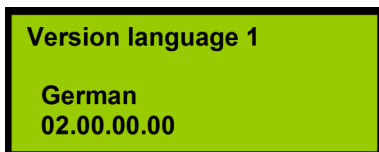

Query Version language 1:

- Return to menu
- Return to menu
- Return to menu
- Return to menu

The following information is displayed: Language name, language pack version.

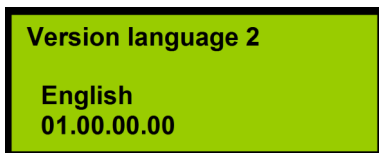

Query Version language 2:

- Return to menu
- Return to menu
- Return to menu
- Return to menu

The following information is displayed: Language name, language pack version.

8.10 Revision

Menu function "Revision"

Via the menu function "Revision", the system can be switched to revision operation and/or revision operation can be ended again.

The following triggerings are suppressed in revision operation:

- Connecting terminal for relay output "Pre-alarm" (Fig. 77/1)
- Connecting terminal for relay output "Fire alarm" (Fig. 77/2)
- Connecting terminal for relay output "Extinguishing" (Fig. 77/3)
- Output "External alarm device" ↪ Chapter 6.3.2 "External alarm devices" on page 53
- Triggering the internal tank.

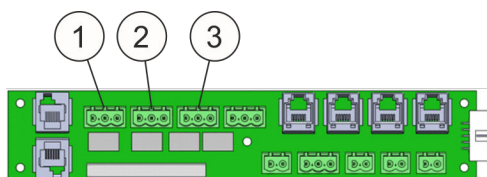

Fig. 77: Connecting terminals



Previous menu item

Exit menu

Next menu item

Switch on
Switch off

Switch on revision:



Previous menu item

Exit menu

Next menu item

Switch on
Switch off

Switch off revision:

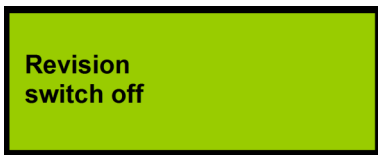

Previous menu item

Exit menu

Next menu item

Switch on
Switch off

8.11 Maintenance

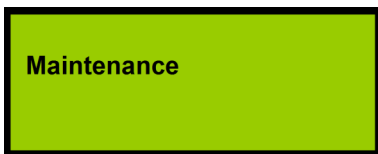

Previous menu item

Exit menu

Next menu item

Activate submenu

The menu "Maintenance" is only accessible to trained Authorized Distributors. A six-digit service code must be input to get to the menu "Maintenance".

8.12 Maintenance menu

For the maintenance display, the *[Reset]* button "Activate submenu" can be used to reach the input point for the service code:



Select number

Abort function

Select digit position

Activate submenu

After inputting the service code, confirmation is given via the service button "Activate submenu". The LED "Operation" starts to blink. The following menus are available to the Authorized Distributor:

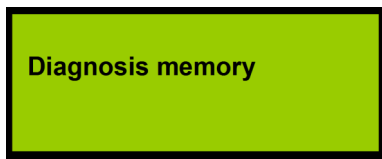

- Confirm change
- Abort function

- Abort function
- Abort function



- Confirm change
- Abort function

- Abort function
- Abort function

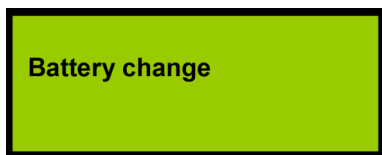

- Previous menu item
- Next menu item

- Exit menu
- Activate submenu



- Previous menu item
- Next menu item

- Exit menu
- Activate submenu



- Previous menu item
- Next menu item

- Exit menu
- Activate submenu

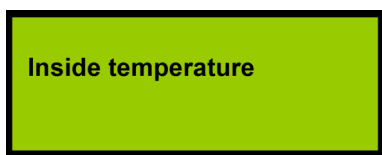

- Previous menu item
- Next menu item

- Exit menu
- Activate submenu

Diagnosis memory:



- Confirm change
- Abort function

- Abort function
- Abort function

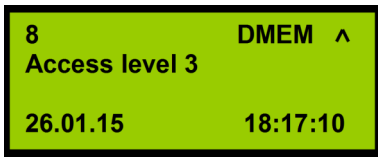

Confirm change



Abort function



Abort function



Abort function

8.12.1 Extinguishing agent monitoring filter time



Confirm change



Abort function



Abort function



Abort function

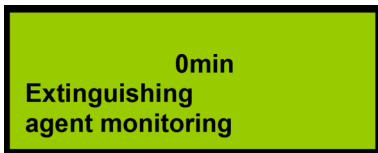

Increase filter time



Abort function



Decrease filter time



Adopt current value

If the value "Extinguishing agent monitoring" is at "0", a loss message from the sensor is reported to the extinguishing agent monitoring immediately. If the value is at "1" or higher, this number states the minutes that the loss message must remain pending, without interruption, before a an extinguishing agent loss is recognized and shown on the display.

8.12.2 Battery change

The operating time of the battery is monitored by a timer. If the battery exceeds the maximum permissible operating time, a corresponding message indicator is shown in the display and the system goes into failure state. There are the following options for resetting this monitoring after a battery change:

- Battery change via the display
- Open the "Battery change" function
- Battery change using the Maintenance Program ↪ *Chapter 10.7 "Operation" on page 97.*

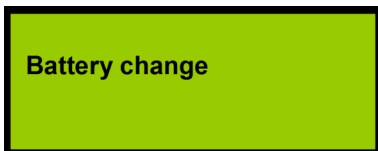

Previous menu item



Exit menu





Next menu item

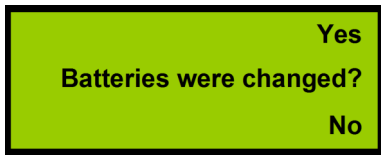

Activate submenu

After launching the function, this query occurs:



-  Confirm change
-  Abort function
-  Abort function
-  Abort function

If the question is answered in the affirmative, the resetting of the operating hours counter must be confirmed in the subsequent dialog:

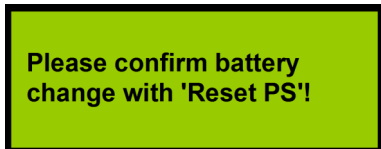

-  Abort function
-  Abort function
-  Abort function
-  Perform function

After the function has been performed, the following confirmation message appears:

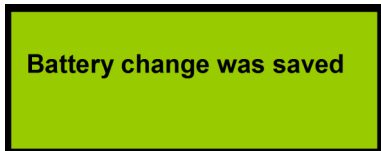

-  Return to menu
-  Return to menu
-  Return to menu
-  Return to menu

After this message, the operating hours counter for the battery is reset, so that the total maximum operating time is available again. If necessary, a previously displayed failure message prompting a battery change is cancelled.

If the function is aborted, a warning message appears:

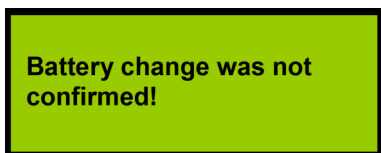

-  Return to menu
-  Return to menu
-  Return to menu
-  Return to menu

If this message is displayed, the operating hours counter for the battery was not reset. It proceeds from the last saved value. Where applicable, a previously displayed failure message prompting a battery change is not cancelled.

8.12.3 Battery state

In the service menu "Battery state", the current measured values for the battery voltage and the internal resistance are determined cyclically and displayed. The following measured values are displayed:

- Battery voltage (mV).
The system is fitted with two batteries (12 V / 2.2 Ah) which are connected in series.
- Inside temperature of the system (°C).
- Internal resistance of the battery (mOhm).
If the internal resistance of 1200 mOhm is exceeded, the batteries must be changed.



Previous menu item



Exit menu



Next menu item



Activate submenu



The current values are determined. The value indicated counts up to approx. 76 (progress bar). No further operation is possible at this stage.

Please wait for this stage to be concluded.

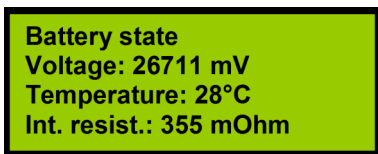

Has no function



Exit display



Has no function



Exit display

8.12.4 Measuring alarm device

The alarm device must be measured so that a wire break or short circuit can be detected via the cyclically determined values. In the menu "Measuring alarm device", the current measured value of the terminating resistor at connection "external AD" is cyclically determined and shown as an AD value. The limit values resulting from this for the monitoring are calculated and displayed automatically. The limit values can be confirmed and saved with *[Reset PS]* "Adopt current value". The menu is exited with *[Reset]* "Exit display" without saving the displayed values.



Previous menu item



Exit menu



Next menu item



Activate submenu



The current values are determined. The value indicated counts up to approx. 55 (progress bar). No further operation is possible at this stage.

Wait for this stage to be concluded.

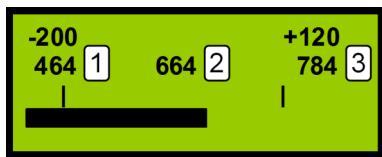

Has no function

Exit display

Has no function

Adopt current value

- 1 lower limit value = determined limit value -200
- 2 determined value
- 3 upper limit value = determined limit value +120

8.12.5 Inside temperature

Service menu "Inside temperature"

In the service menu "Inside temperature", the minimum and maximum permissible temperature of the system is defined and saved.

In order to change between the setting of the maximum and the minimum permissible temperature, both arrow buttons must be pressed at the same time.

Factory setting for operation of the system is:

- minimum: +10°C
- maximum: +40°C [Chapter 14 "Technical data" on page 120.](#)

If the maximum permissible temperature is exceeded or if the temperature falls below the minimum permissible temperature, a failure message results as the system may be damaged. In this case, it must be inspected by the manufacturer.

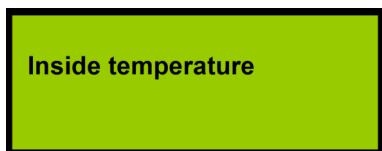

Previous menu item

Exit menu

Next menu item

Activate submenu

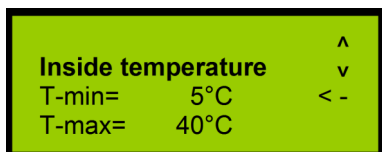

Increase temperature

Abort function

Decrease temperature

Adopt current value

8.12.6 Operating hours counter

In addition to the monitoring of the operating hours of the battery, the system also monitors the operating time since the last maintenance work was performed. If this exceeds the permissible maintenance interval, a failure message is generated (LED display "Common failure" and triggering relay "Common failure").

There are the following options for resetting this message:

- Resetting via the *[Reset]* button.
An Authorized Distributor Reset must take place to reset this message. To this end, the transparent protective film at the housing of the system must be opened. On the control card CPU3, the *[RESET]* button (Fig. 78/1) is to be actuated for longer than three seconds. Afterwards, the failure message and the operating hours counter of the system are reset.
- Resetting via the Maintenance Program ↪ *Chapter 10.7 "Operation" on page 97*: Press the "Maintenance" button.

Resetting in this way has no effect on the monitoring of the operating time of the battery.

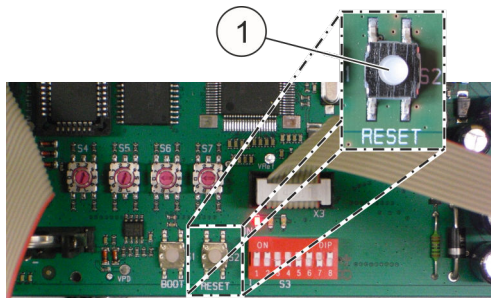

Fig. 78: *[Reset]* button

NOTICE

Damage due to incorrectly recorded operating hours!

Both the operating hours counter for the maintenance interval and the operating hours counter for the batteries are based on the real time clock that is installed. Adjusting this clock can, under certain circumstances, affect correct recording of the operating hours.

Incorrectly recorded operating hours may result in late notifications for a battery change or maintenance. This creates the danger that the system does not function correctly.

- Do not manipulate the time.

9 Messages display

Personnel: ■ Person in charge of the system

Messages are shown on the display for the following states.

Message	Cause	Necessary measure
State OK	<ul style="list-style-type: none"> System in normal range. 	None.
Extinguishing triggered	<ul style="list-style-type: none"> Extinguishing was activated due to a fire. 	Inform service, installation of a new tank system.
Fire	<ul style="list-style-type: none"> Fire is detected. 	None.
Manual release	<ul style="list-style-type: none"> Manual release. 	Inform service, installation of a new tank system.
Failure manual release	<ul style="list-style-type: none"> Wire break or short circuit on the manual call point line. Short circuit or wire break at the manual call point e.g. wire not connected. Terminating resistor is missing, if no manual call point is intended. 	Check the manual call point connections Where applicable connect wire or insert terminating plug. Terminating resistor manual call point not present (1.8 kΩ), see description manual call point ↗ <i>Chapter 6.3.7 “Manual call point” on page 63.</i>
Fire alarm detector 1	<ul style="list-style-type: none"> Fire is detected. 	None.
Fire alarm detector 2	<ul style="list-style-type: none"> Fire is detected. 	None.
Blocking by door cont.	<ul style="list-style-type: none"> Extinguishing system is blocked by the door being opened. 	Close the door, check the door contact switch. Check whether there is still a terminating resistor in the RJ12 plug or connected to the door contact clamp.
Failure door contact	<ul style="list-style-type: none"> Wire break or short circuit on the door contact line. Short circuit or wire break at the door contact e.g. wire not connected. Terminating plug is missing, if no door contact is intended. Output and input of the door contact are inverted. 	Check the door contact connections. Where applicable connect wire or insert terminating plug. Wire the door contact properly ↗ <i>Chapter 6.3.5 “Door contact / blocking” on page 55.</i>
Failure power supply unit (PSU)	<ul style="list-style-type: none"> Power supply unit no longer emits any voltage if, for example, a mains lead is not connected. 	Restore the power supply.

Message	Cause	Necessary measure
Failure battery	<ul style="list-style-type: none"> Battery deeply discharged. Battery is defective. Battery not connected. 	Check whether there was a mains failure. If yes, then charge the batteries for 24 hours in the system. The failure message must then be able to be reset. If this is not possible, the batteries must be changed.
Failure battery int. resistance	<ul style="list-style-type: none"> Battery is defective. 	Change batteries.
Failure (too high) air flow	<ul style="list-style-type: none"> Suction pipe has loosened. Suction pipe is broken. Too many suction bores. Blind plug is missing. 	<p>Fasten the suction pipe.</p> <p>Replace the suction pipe.</p> <p>Seal some suction bores.</p> <p>Mount the blind plug.</p>
Failure (too low) air flow	<ul style="list-style-type: none"> Suction pipe heavily contaminated. The filter in the air flow monitoring is contaminated. There are not enough suction bores, there are no suction bores or the suction bores are too small in the pipe system. 	Clean the suction pipe. If the failure continues to exist, replace the air filter.
Failure detector 1	<ul style="list-style-type: none"> Detector head 1 defective. Detector head 1 is missing. 	Inform service.
Failure detector 2	<ul style="list-style-type: none"> Detector head 2 defective. Detector head 2 is missing. 	Inform service.
Failure Communication	<ul style="list-style-type: none"> Power supply (24 V) to the slave is interrupted. Electrical defect. CAN bus connecting cable (Master/ Slave) to the Slaves not connected. Addressing at the Master or Slaves is wrong. 	<p>Check / insert power supply (24 V).</p> <p>Inform service.</p>
Failure tank triggering	<ul style="list-style-type: none"> Blocking switch actuated (position "Agent disconnect [blocked]"). Wire break on the trigger line to the propellant cartridge. 	<p>Switch blocking switch to "Agent connect [not blocked]" position.</p> <p>Inform service.</p>
Extinguishing agent loss	<ul style="list-style-type: none"> Filling level too low (internal/external). System not installed horizontally. Loss of extinguishing agent in the tank (internal/external). 	<p>Align the system horizontally and check whether the failure message goes away.</p> <p>Inform service.</p>
Failure extinguishing agent	<ul style="list-style-type: none"> Wire break or short circuit on the line "external tank". 	Inform service.

Message	Cause	Necessary measure
Perform main-tenance	<ul style="list-style-type: none"> Operating time has reached the main-tenance interval. 	Inform service. Call for mainte-nance.
Battery change required	<ul style="list-style-type: none"> Operating time has reached maximum durability. 	Inform service. Call for mainte-nance.
System failure	<ul style="list-style-type: none"> Serious internal problem. 	Reboot the system. Inform service.
Date / time	<ul style="list-style-type: none"> Actuation of the buttons "Up" / "Down". 	None.
Event memory	<ul style="list-style-type: none"> Actuation of the buttons "Up" / "Down". 	None.
Air flow cali-bration	<ul style="list-style-type: none"> Actuation of the buttons "Up" / "Down". 	None.
Lamp test	<ul style="list-style-type: none"> Actuation of the buttons "Up" / "Down". 	None.
Version infor-mation	<ul style="list-style-type: none"> Actuation of the buttons "Up" / "Down". 	None.
Firmware ver-sion	<ul style="list-style-type: none"> Actuation of the buttons "Up" / "Down". 	None.
Control panel version	<ul style="list-style-type: none"> Actuation of the buttons "Up" / "Down". 	None.
BIOS version	<ul style="list-style-type: none"> Actuation of the buttons "Up" / "Down". 	None.
Checksums	<ul style="list-style-type: none"> Actuation of the buttons "Up" / "Down". 	None.
Air flow indica-tion	<ul style="list-style-type: none"> Actuation of the buttons "Up" / "Down". 	None.
Automatic air flow calibration	<ul style="list-style-type: none"> Actuation of the buttons "Up" / "Down". 	None.
Manual air flow calibration	<ul style="list-style-type: none"> Actuation of the buttons "Up" / "Down". 	None.
Pre-alarm	<ul style="list-style-type: none"> Fire detector 1 has detected. 	Acknowledge.
Triggering extinguish. system	<ul style="list-style-type: none"> Fire detected. Manual release. 	Inform service.
Tank not empty	<ul style="list-style-type: none"> Is reported after an simulated extinguishing has occurred (in blocked state) if the tank was not emptied in the prescribed time. 	Acknowledge.
Tank empty	<ul style="list-style-type: none"> Is reported after extinguishing has occurred as the tank is then empty. 	Inform service. Call for mainte-nance.
Mains failure	<ul style="list-style-type: none"> Mains power supply unavailable. 	Rectify any possible failures in the mains power supply.

Message	Cause	Necessary measure
Outage battery charging	<ul style="list-style-type: none">• Outage in the battery charging circuit.	Inform service.
Failure ignition cap.	<ul style="list-style-type: none">• The capacity of the ignition capacitor is no longer sufficient or a release has just occurred.	Inform service.
Failure external supp.	<ul style="list-style-type: none">• Short circuit on the 24 V external line.	Rectify the short circuit or overload. Inform service.
Battery not full	<ul style="list-style-type: none">• Battery not fully charged.	None.

10 Maintenance program

Personnel: ■ Authorized Distributor

NOTICE

Damage to the system due to malfunction!

In the event of an incorrect data transfer to the system, functionally relevant components may be deactivated.

- The maintenance program must be operated only by persons qualified to do so.
-

10.1 Installing the maintenance program

Requirements of the operating system: Windows XP or later and Microsoft.NET Framework 4.0 or later.

In most cases, the maintenance program can only be installed with Administrator's rights. Proceed as follows to do this:

1. ➤ Copy the zip file into a directory and unpack.
2. ➤ Create a shortcut on the desktop.
3. ➤ Open the window to change the shortcut:
"Properties" >> "Shortcut" >> "Target".
4. ➤ Change the extension of the shortcut to:
`\Wartungsprogramm.exe" hamburg`

***i** Adding "hamburg" enables additional functions for the Authorized Distributor.*

INFORMATION

*In order to display the maintenance program in English, change the extension to:
`\Wartungsprogramm.exe" en hamburg`*

10.2 Homepage

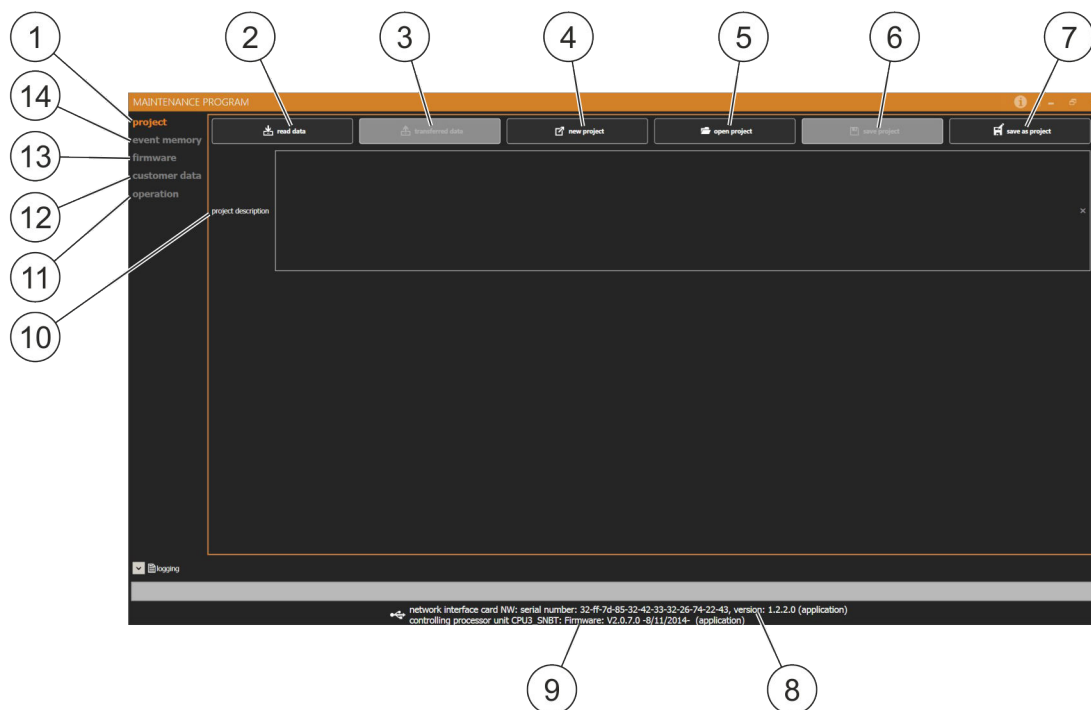

Fig. 79: Maintenance program homepage

The following options are shown after starting the maintenance program:

- Project (Fig. 79/1) ↪ Chapter 10.3 “Project” on page 94
 - Read data (Fig. 79/2) (gray background, if no system is connected)
 - Transfer data (Fig. 79/3) (gray background, if no data has been imported yet)
 - New project (Fig. 79/4)
 - Open project (Fig. 79/5)
 - Save project (Fig. 79/6) (gray background, if no project was opened previously)
 - Save project as (Fig. 79/7)
- Event memory (Fig. 79/14) ↪ Chapter 10.4 “Event memory” on page 94
- Firmware (Fig. 79/13) ↪ Chapter 10.5 “Firmware” on page 94
- Customer data (Fig. 79/12) ↪ Chapter 10.6 “Customer data” on page 95
- Operation (Fig. 79/11) ↪ Chapter 10.7 “Operation” on page 97

The following information is displayed:

- Network Interface Card serial number, Network Interface Card version number (Fig. 79/8)
- Firmware version (Fig. 79/9)

The following input option exists:

- The project can be described in the project description (Fig. 79/10). This description is saved with the project via "Save project as" or via "Save project" with the data on the **PC**. The project description is not transferred to the system (DET-AC III Master) and it is not saved in the system. The project description is not available after the data has been exported from a system.

10.3 Project

Importing data

All data from the system connected is imported into the maintenance program.

Transferring data

All data, which is present in the maintenance program, is transferred to the system that is connected. The transfer can only occur if existing data was imported in advance, customer data was input, or a project was loaded.

New project

The "New project" function can be used to completely revise the data in a project. All set customer data will be deleted!

Opening a project

A saved project can be opened and transferred to the system.

Saving a project

The project is saved if the path is known.

Saving a project as

A project is saved under a previously input path and name.

10.4 Event memory

Pending and past events can be displayed and saved using the event memory.

- **AMEM:** events currently pending.
- **EMEM:** all events that have occurred up to the point in question.
- **DMEM:** Firmware diagnostics records.

10.5 Firmware

- The most up-to-date version can be transferred using the "*Open + transfer firmware*" button.
- Designation SW (software card CPU)
*SW_OnU_SNBT_GerEng_CPU2_0_7_0_2014_08_11.hex**)
This is transferred to the CPU if any changes are made.

- Designation SW (software CPU, software network NW and software control panel BT)
`SW_OnU_SNBT_GerEng_CPU2_0_7_0_2014_08_11_BT3_02_00_01_00_2014_05_22_NWoKDF1_2_2_0_2014_07_07.hex`*)
 This is transferred to the active extinguishing system ("DET-AC III Master") if changes are made.
 - Designation SW (software CPU and software network NW)
`SW_OnU_SNBT_GerEng_CPU2_0_7_0_2014_08_11_NWoKDF1_2_2_0_2014_07_07.hex`*)
 This is transferred to the extinguishing system ("DET-AC III Slave") if changes are made.
- *) Sample designation

10.6 Customer data

Customer data is divided into four main categories:

- General ↪ *Chapter 10.6.1 "General" on page 95.*
- Components ↪ *Chapter 10.6.2 "Components" on page 95.*
- Timeouts ↪ *Chapter 10.6.3 "Timeouts" on page 96.*
- Threshold values ↪ *Chapter 10.6.4 "Threshold values" on page 96.*

10.6.1 General

- Description: Any text, which is used to describe the system/project, can be entered in the description. During data transfer, this description is transferred to the system (DET-AC III Master) Any text, which is used to describe the system/project, can be entered in the description. During data transfer, this description is transferred to the system.
- Date Prog.: Date when customer data was last transferred.
- System password: Defines the six-digit password (numbers 0-9) for maintenance mode.
- Last maintenance: Displays the time of the last maintenance. This value is set to the current system time by actuating the maintenance button in the "Operation" directory.
- Last battery change: Displays the time of the last battery change. This value is set to the current system time by actuating the battery change button in the "Operation" directory.

10.6.2 Components

For components, the tank and connection of an external alarm device (AE) can be selected. The systems are delivered with the following setting:

System	Tank	Alarm device (AE)
DET-AC III Master	Internal	Not present
DET-AC III Slave	Internal	Not present
EFD III	Not present	Not present

10.6.3 Timeouts

- Browsing [20 s]*: Switches back from the display of older messages to the basic message display state.
- Menu [30 s]*: Returns to the basic state from the operating menu.
- Display [40 s]*: Returns from a function display to the menu.
- Program [1800 s]*: Returns from a programming function to the menu.
- Message [15 s]*: Duration of the event display for a menu function.
- Code [15 s]*: Timeout for menu functions without their own timeout.
- Edit [60 s]*: Exits input mode.
- Test [1800 s]*: Exits the display mode of a diagnostics function (air flow display, air flow calibration, alarm device (AD) calibration, battery status indicator, temperature indicator).
- Battery failure is only displayed after 60 seconds*.
- Power supply failure is displayed after 60 seconds*.
- Maintenance is displayed after a maximum of 730 days*.
- Battery change is displayed after 730 days*.
- Air flow monitoring filter time: This fault is only displayed after 120 seconds*.
- Extinguishing delay: Extinguishing is delayed by 0 seconds*.
i The delay time can be set to a maximum of 120 seconds.
 When configuring the setting, observe the applicable provisions, guidelines, and laws at the location.

* Factory setting

10.6.4 Threshold values

- Air flow monitoring lower threshold: the lower value of the air flow calibration is displayed.
- Air flow monitoring upper threshold: the upper value of the air flow calibration is displayed.
- AE (alarm device) monitoring lower threshold: the lower value of the alarm device is displayed (wire break/short circuit monitoring).
- AE (alarm device) monitoring upper threshold: the upper value of the alarm device is displayed (wire break/short circuit monitoring).
- Extinguishing agent monitoring filter time: Setting for the delay in minutes until display of the extinguishing agent leak.
- Temperature MIN [°C]: Setting for the lowest operating temperature (restricted by the manufacturer to 10 °C (50 °F)).
- Temperature MAX [°C]: Setting for the highest operating temperature (restricted by the manufacturer to 40 °C (104 °F)).

- External valve (lower threshold): the lower value of the external valve is displayed (wire break/short circuit monitoring).
- External valve (upper threshold): the upper value of the external valve is displayed (wire break/short circuit monitoring).

10.7 Operation

Lamp test

Puts the system into the lamp test. A second actuation ends the lamp test.

Revision

Puts the system in revision. A second actuation results in the revision mode being exited.

The following triggerings are suppressed in revision operation:

- Connecting terminal for relay output *"Pre-alarm"* (Fig. 77/1)
- Connecting terminal for relay output *"Fire alarm"* (Fig. 77/2)
- Connecting terminal for relay output *"Extinguishing"* (Fig. 77/3)
- Output *"External alarm device"* ↪ Chapter 6.3.2 *"External alarm devices"* on page 53
- Triggering the internal tank.

Battery change

Adopts the system's current time state as the time of the last battery change. No safety queries occur in this process in contrast to when this function is activated on the control panel.

Maintenance

Adopts the system's current time state as the time of the last maintenance.

"Reset": Resets the system.

"Reset PS": Resets battery failures.

USB-CPU configuration

By actuating this button, the "Network Interface NW" card (Fig. 8), which is currently connected to the PC, is reprogrammed in order to remedy an increase in the number of virtual COM ports. In addition, the setup program is automatically supplied with appropriate parameters so that the actual programming procedure does not require any further operations. The configuration program is automatically installed during the program installation.

INFORMATION

This configuration only has to be performed for component assemblies with a production date prior to July 8, 2014 ("Network Interface NW" card with component assembly numbers prior to 0214 and from 0214-0001 up to and including 0214-0349).

If the system is no longer to be recognized following USB configuration, then configuration has to be performed again. Configuration is then only possible if the maintenance program displays "No device connected".

Time

- Read out time: Reads the time out of the CPU of the system and displays it in the "time" and "date" fields.
- Set date/time: Writes the values from the "time and date field" into the CPU of the system.
- System time: Sets the "time" and "date" fields to the PC system time.
- Time/date field: Defines the time that is to be written into the system by means of "Set date/time". Manipulations of these fields do not become effective until the "Set date/time" button is clicked.

11 Maintenance

WARNING

Danger due to a lack of fire safety!

If the system has been taken out of service there is no fire safety. Fires breaking out can cause severe injuries and significant property damage.

- Keep functioning and suitable reserve extinguishing equipment on hand (e.g. suitable fire extinguishers).
- Do not shut down the system longer than necessary.
- Place the system in service immediately after conclusion of the inspection and maintenance tasks.

The owner performs regular visual inspections and functional checks described for the owner.

Maintenance of and repairs to the system are performed by a trained Authorized Distributor.

An authorized specialist company for the maintenance and troubleshooting tasks is a company whose employees have been trained by the manufacturer of the system. As a general rule, this is an employee of the installation company.

The manufacturer accepts no liability for improper handling and insufficient or non-performed regular checks and maintenance.

11.1 Regular checks by the owner

Personnel: Person in charge of the system

Daily checks

- The system must be in a failure-free state (operating state without failure or alarm: the green LED lights up, there are no yellow failure LEDs or red alarm LEDs lit up or blinking).

If the system is connected to a CMC III, the control can also be done via the website or the superordinate control system.

- Failures present are to be recorded and rectification is to be initiated.

Monthly checks

- Suction pipe and discharge nozzle must not exhibit any external damage and the discharge nozzle must be free from contamination and spray obstacles.
- Suction pipe connections must not be broken off.
- Have the air flow measured value displayed (↪ *Chapter 8.6 "Air flow calibration" on page 73*) and compare it with the value from commissioning report in order to determine contamination where applicable. The maximum permissible deviation from the set value is 10%.
- Perform a lamp test ↪ *Chapter 8.3.2 "Main menu" on page 70*.

11.2 Inspection, maintenance and repairs by the Authorized Distributor

- Personnel: ■ Authorized Distributor
- Protective equipment: ■ Safety goggles
■ Safety gloves
■ Safety footwear

⚠ WARNING

Risk of injury due to improperly executed repair tasks!

Improper repairs can cause severe injuries and significant property damage.

- Repair tasks must only be performed by specifically qualified personnel.
- As a general rule, tanks which have not released, i.e. those that are pressurized, must not be opened or stripped down.

⚠ WARNING

High voltage!

An imminent risk of death or severe physical injury due to electric shock.

- All tasks at the open system may only be performed by electricians with appropriate training.

⚠ CAUTION

Danger of injury from faulty release!

A faulty release of the system may cause injuries and property damage.

- Block all networked systems using the blocking switch (Fig. 80/arrow) prior to performing maintenance work:
switch the blocking switch to "Agent disconnect [blocked]" (Fig. 80/II).

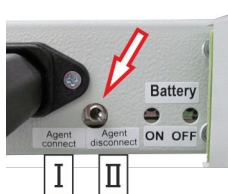

Fig. 80: Blocking switch

NOTICE

Property damage from alarm release!

The alarm can/should be released during maintenance tasks.

- Shut down/bypass all downstream controllers (e.g. transmission or shutdown) prior to performing any maintenance tasks.

NOTICE**Damage due to compressed air!**

Compressed air can damage components such as electronic parts.

- Never clean the system with compressed air.

Precise knowledge of the system(s) in question is required for the performance of service tasks. This includes:

- DET-AC III Master (Part No. 7338.121)
- DET-AC III Slave (Part No. 7338.321)
- EFD III (Part No. 7338.221)

The respective system type, operating instruction and the Firmware installed when delivered can be ascertained from the information on the type plate (part number, serial number, order number).

Before the start of the inspection/maintenance, the current maintenance information is to be requested from the manufacturer!

Reference to chapter „task“ page reference	Annual inspect./ maintenance	Maintenance every 2 years	Maintenance every 10 years
☞ Chapter 11.2.1 “Checking for proper installation” on page 104	X		
☞ Chapter 11.2.2 “Checking for external damage” on page 104	X		
☞ Chapter 11.2.3 “Recording the WA No. / Part No. / F. No.” on page 104	X		
☞ Chapter 11.2.4 “Recording the date of the current maintenance / inspection” on page 104	X		
☞ Chapter 11.2.5 “Recording the current version” on page 104	X		
☞ Chapter 11.2.6 “Checking and recalibrating the air flow measured values” on page 104	X		
☞ Chapter 11.2.7 “Checking current fault messages, history since last maintenance” on page 105	X		
☞ Chapter 11.2.8 “Performing a lamp test” on page 105	X		
☞ Chapter 11.2.9 “Checking the discharge nozzle for contamination” on page 105	X		
☞ Chapter 11.2.10 “Checking the temperature indicator” on page 105	X		
☞ Chapter 11.2.11 “Checking the setting of date and time” on page 105	X		

Reference to chapter „task“ page reference	Annual inspect./ maintenance	Maintenance every 2 years	Maintenance every 10 years
↳ Chapter 11.2.12 “Checking the set integration time for air flow monitoring” on page 105	X		
↳ Chapter 11.2.13 “Checking the last battery change” on page 105	X		
↳ Chapter 11.2.14 “Checking the function of the door contact switch” on page 106	X		
↳ Chapter 11.2.15 “Checking the blocking switch” on page 106	X		
↳ Chapter 11.2.16 “Checking for proper connection of the transmission” on page 106	X		
↳ Chapter 11.2.17 “Checking whether shutdown occurs” on page 106	X		
↳ Chapter 11.2.18 “Reading out and transferring data” on page 106	X		
↳ Chapter 11.2.19 “Checking the electrical connections” on page 106	X		
↳ Chapter 11.2.20 “Cleaning the pipe system” on page 106	X		
↳ Chapter 11.2.21 “Changing the batteries” on page 107		X	
↳ Chapter 11.2.22 “Changing the battery “control card CPU3” on page 107			X
↳ Chapter 11.2.23 “Checking the DIP switch on the control card CPU3” on page 107	X		
↳ Chapter 11.2.24 “Checking the networking of the systems” on page 107	X		
↳ Chapter 11.2.25 “Changing the filter” on page 108	X		
↳ Chapter 11.2.26 “Checking for contamination in the housing” on page 108	X		
↳ Chapter 11.2.27 “Checking loss monitoring” on page 108	X		
↳ Chapter 11.2.28 “Power supply” on page 108	X		
↳ Chapter 11.2.29 “Cover seal” on page 109	X		
↳ Chapter 11.2.30 “Checking the total weight” on page 109	X		
↳ Chapter 11.2.31 “Testing the release” on page 109	X		
↳ Chapter 11.2.32 “Changing fire detectors” on page 109			X
↳ Chapter 11.2.33 “Changing the tank” on page 110			X

For annual inspection/maintenance, the system is taken out of the switch cabinet in order to perform bigger maintenance tasks. It is necessary to consult the owner in this instance.

In order to avoid failures at a superordinate position during servicing tasks, revision can be actuated.

INFORMATION

Many sensitive, networked components/servers are mounted in switch cabinets. Significant loss can be incurred by the owner in the event of damage or careless actions. Act with care so that no existing plug connections are removed or damaged.

It is preferable for maintenance to take place on a fixed workspace which was designed for this purpose and has a 100 V to 240 V connection.

Annual Inspection/Maintenance (Authorized Distributor)

Visual inspection, full maintenance (e.g. check and clean the suction pipe and discharge nozzle where applicable, check the cover seal, replace the filter for the air flow sensor where applicable, check and set air flow calibration where applicable) and function test.

The event memory must be checked for failures ↪ *Chapter 8.5 “Reviewing the event memory” on page 72.*

In the course of maintenance, the system is checked fully and, where applicable, put back into target state. Non-compliance with these intervals can cause failures and false alarms and consequently to faulty extinguishing.

During maintenance, the total weight of the system must be reported.

Maintenance every two years (Authorized Distributor)

The Authorized Distributor must perform maintenance work to the system at least every two years. This maintenance prompt is shown in the display.

After not later than two years, as part of the two-yearly maintenance, the batteries for the emergency power supply must be changed.

A total service life of 10 years is set for the integrated detectors employed in the system if used in dry areas free from combustible dust and corrosive atmosphere. Regular inspections, maintenance, cleaning and calibration where applicable are prerequisites for this.

In isolated cases, shorter periods for changes may be required depending on ambient conditions or fire detector type.

The maintenance tasks are documented in the checklists that are intended to serve this purpose.

11.2.1 **Checking for proper installation**

Check whether the system is installed in the upper third.

Check and report horizontal installation using a spirit level.

11.2.2 **Checking for external damage**

Check the pipe system, the connections and the system itself for external damage.

11.2.3 **Recording the WA No. / Part No. / F. No.**

Read the factory order number (WA No.), the part number (Part No.) and the production number (F. No.) of the system on the labels and report them in the service report. The labels are on the housing cover and on the rear of the system.

11.2.4 **Recording the date of the current maintenance / inspection**

Fill out the report for the date of the current and last maintenance by hand or read it out via the Maintenance Program ↪ *Chapter 10.6 "Customer data" on page 95.*

11.2.5 **Recording the current version**

Refer to the control menu for the current version states ↪ *Chapter 8.9 "Menu "Version information"" on page 77.*

- Firmware version
- Control panel version
- BIOS version

Record the different versions in the service report and compare with the old data. A deviation is to be noted with an explanation.

11.2.6 **Checking and recalibrating the air flow measured values**

Refer to the control menu for the current measured values and report them ↪ *Chapter 8.6 "Air flow calibration" on page 73.*

The following measures are required in the event of a deviation from the old values (a tolerance of $\pm 10\%$ is permissible):

- Check the pipe system for contamination.
- Check the pipe system for leaks.
- Check that the holes in the pipe system are aligned correctly.

After correcting the fault, recalibrate the air flow and compare with the old values ↪ *Chapter 8.6 "Air flow calibration" on page 73.*

11.2.7 Checking current fault messages, history since last maintenance

Check the history since last maintenance. Correct the current fault messages. Record the fault via the Maintenance Program ↪ *Chapter 10.4 “Event memory” on page 94*. In the event of fault messages, discuss them with the owner and report the causes/reasons.

11.2.8 Performing a lamp test

A lamp test is performed in order to check the LEDs of the system ↪ *Chapter 8.1 “LED displays” on page 67*. This check can be performed via the Maintenance Program ↪ *Chapter 10.7 “Operation” on page 97*. The result is to be reported.

11.2.9 Checking the discharge nozzle for contamination

The nozzle holes must be visually checked for contamination and inclusions. In the event of contamination, the holes must be cleaned.

11.2.10 Checking the temperature indicator

Check the temperature indicator on the small cover in the front section for temperatures possibly being exceeded ↪ *Chapter 6.2.3 “Temperature indicator” on page 42*. Defects in electrical components can result from the temperature being exceeded. Contact the Authorized Distributor if the temperature indicator is dark in color and have the system replaced.

11.2.11 Checking the setting of date and time

Check the date and time and correct where applicable ↪ *Chapter 10.7 “Operation” on page 97*.

11.2.12 Checking the set integration time for air flow monitoring

Check and report the set integration time. The ex works set value is 5 seconds ↪ *Chapter 8.6.3 “Setting the integration time for the air flow monitoring (filter time)” on page 76*.

11.2.13 Checking the last battery change

Refer to the previous report or the Maintenance Program ↪ *Chapter 10.6 “Customer data” on page 95* for the last battery change and document it in the service report.

11.2.14 Checking the function of the door contact switch

Check whether the door contact switches including the magnets are firmly mounted. Check whether the door contact switch switches safely.

11.2.15 Checking the blocking switch

As soon as the blocking switch of the system is set to "Agent disconnect [blocked]", the yellow LED (top right) on the front panel lights up.

11.2.16 Checking for proper connection of the transmission

A pending failure (e.g. via blocking switch or door contact switch) can be transmitted to a permanently manned location. This function is to be checked.

11.2.17 Checking whether shutdown occurs

Signals for the shutdown of external electrical devices (e.g. fans) can be transmitted via the potential-free relay outputs. Check whether shutdown of the external devices is functioning.

11.2.18 Reading out and transferring data

Read out and archive the data of the system for every maintenance and installation.  Chapter 10.3 "Project" on page 94 describes how customer data can be read out and changed.

11.2.19 Checking the electrical connections

WARNING!

Risk of death or severe physical injury due to electric shock!

 Check and repair where applicable the electrical connections of the system and the connections to the additional electrical devices that are connected.

11.2.20 Cleaning the pipe system

NOTICE

Property damage from compressed air!

Compressed air can damage components and fire detectors.

- Never blow into the system with compressed air.
-

Check and clean the pipe system in the event of a deviation to the air flow value. The system is dismantled and can be cleaned with compressed air in the event of heavy contamination.

11.2.21 Changing the batteries

It is to be observed when changing the batteries that the batteries are connected in series.

The change is to be reported on the system (service label).

The operating hours counter for the batteries can be reset via the display *Battery change* ↪ Chapter 8.12.2 “Battery change” on page 83 or via the Maintenance Program Operation ↪ Chapter 10.7 “Operation” on page 97.

11.2.22 Changing the battery "control card CPU3"

⚠ WARNING!

Risk of death or severe physical injury due to electric shock!

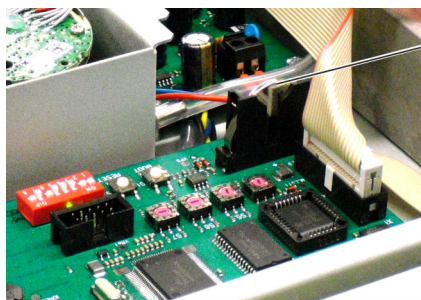

1 The replacement of the battery "control card CPU3" (Fig. 81/1) must be reported.

After the replacement of the battery check the real time.

Fig. 81: Battery "control card CPU3"

11.2.23 Checking the DIP switch on the control card CPU3

The DIP switch for the door contact as well as for the language setting can be found on the control card CPU3.

- The setting of the switch for the door contact can be found in ↪ Chapter 6.3.5 “Door contact / blocking” on page 55.
- The setting for the language can be found in ↪ Chapter 6.2.4 “Language setting for display and operation” on page 42.

11.2.24 Checking the networking of the systems

The networking of the systems is described in ↪ Chapter 6.2.5.4 “Installation of the system and suction pipes when monitoring several 19" cabinets” on page 47 and in ↪ Chapter 6.3.6 “Combination of systems” on page 58.

This networking is to be checked with the removal of the mains lead and, where applicable, corrected. If any changes are made, they must be reported.

11.2.25 Changing the filter

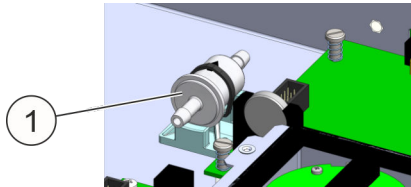

Fig. 82: Filter

The used filter (Fig. 82/1) is released from the hoses and the new filter is put into exactly the same position.

11.2.26 Checking for contamination in the housing

Removed any contamination in the housing (e.g. dust, lint).

11.2.27 Checking loss monitoring



Fig. 83: Loss monitoring

To check the function of the loss check, the system must be connected electrically and raised on the right hand side at an angle of roughly 20°.

⇒ In the display (Fig. 83/1) the message “Extinguishing agent loss” is shown.

INFORMATION

Set the filter time for the check to zero; reset it to the set value afterwards.

11.2.28 Power supply

⚠ WARNING!

Risk of death or severe physical injury due to electric shock!

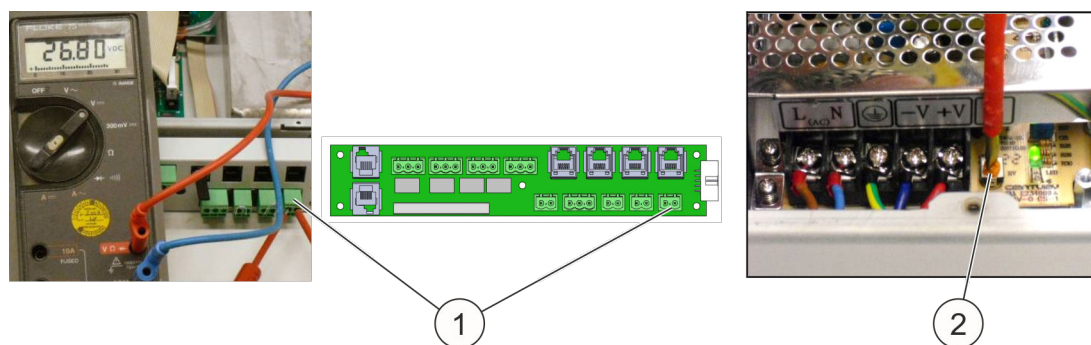

Fig. 84: Power supply

To check the power supply for the additional external devices, the voltage is measured at the rear of the system (Fig. 84/1). For a system connected to the network the voltage must be $26.8^{0/-0.3}$ Volt. The voltage can be set exactly at the potentiometer (Fig. 84/2) of the power supply.

11.2.29 Cover seal

The seal on the inside of the cover is to be checked for damage and replaced where applicable. In the event of damage to the cover seal, it is possible that the air flow monitoring is not functioning correctly.

11.2.30 Checking the total weight

To prevent a gradual process of extinguishing agent loss, the total weight of the system must be checked and reported. A calibrated scale for loads of up to 20 kg and 10 g resolution is needed for this.

11.2.31 Testing the release

⚠ CAUTION

Risk of injury from faulty release!

A faulty release of the system may cause injuries and property damage.









- Block the system before the release is tested to avoid unwanted extinguishing. This applies to both Type DET-AC III Master and for Type DET-AC III Slave.

A check of the alarm function is performed to test the function of the fire detectors. The test gas "Solo A3" [company No Climb] (part no. 905904) is needed for this. The procedure is described in [Chapter 6.2.8.4 "Fire detectors" on page 50](#).

11.2.32 Changing fire detectors

The fire detectors in use have to be replaced every ten years (end of service life) at the latest.

11.2.33 Changing the tank

1.  **WARNING! Danger due to tank change!**
Observe the safety instructions  *Chapter 11.3.1 "Safety instructions for the tank change" on page 111.*
2.  Remove the tank  *Chapter 11.3.2 "Removal" on page 112.*
3.  Dispose of the old tank in a proper and professional manner.
 The fastening material is not included in the scope of delivery of the new tank to be installed. Keep the fastening material if the new tank is not installed directly after the removal of the old tank.
4.  **WARNING! Danger of a faulty release!**
Ensure that the blocking switch is set to "Agent disconnect [blocked]" before installing a new tank.
5.  Install the new tank in the reverse order.

11.2.34 Concluding the inspection

- Put the system in service again according to the installation instructions in this operating instruction.
- Check whether installation, as before, corresponds to the operation and installation conditions described in this operating instruction. In doing so, also check for any possible openings in the cabinet which could perhaps obstruct successful extinguishing.

11.3 Repairs after a release

- Personnel:
- Qualified specialist personnel
 - Qualified electrician
- Protective equipment:
- Safety goggles
 - Safety gloves
 - Safety footwear

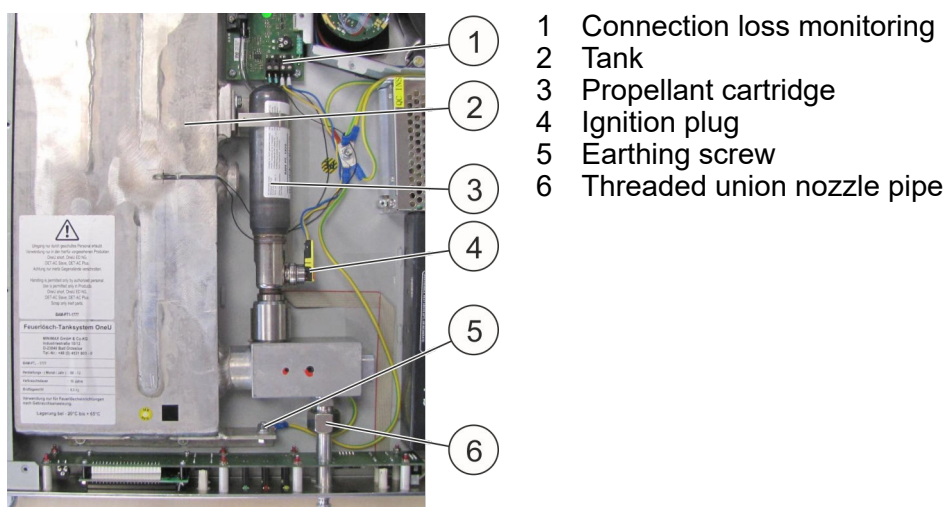

Fig. 85: Overview tank

11.3.1 Safety instructions for the tank change

WARNING

Danger for insufficiently qualified personnel!

Insufficiently qualified personnel is incapable of assessing the risk involved when changing the tank and may cause severe or fatal injuries to themselves or others.

- The removal of an empty tank after a release and the installation of a new full tank may only be performed by trained personnel using the materials and tools intended for the task.

WARNING

Risk of death due to electric shock!

An imminent risk of death or severe physical injury due to electric shock exists if live components are touched.

- Allow only qualified electricians to work on electrical components and the electrical connection.
- Disconnect the system from the power supply:
 - Remove the mains lead.
 - Remove all electrical connections.
 - Actuate the battery button "Battery OFF".

WARNING

Danger due to high pressure!

The propellant cartridge of the release unit is pressurized in an unreleased state at 620 bar (8992 psi). Severe physical injury can result from damage to a pressure hull in an unreleased state.

- Allow only trained personnel to handle and install a new full tank.

11.3.2 Removal

Required tools:

- Slotted screwdriver (size 3.0) for wire reed contact under terminal
- Torx screwdriver (size 10) for cover screws
- Socket wrench 5.5 mm
- 8 mm (flat) spanner for the earthing screws
- Stable storage area

INFORMATION

Only use suitable tools when changing the tank.

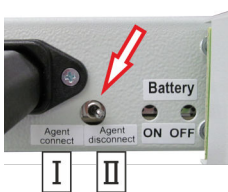

Fig. 86: Blocking switch (on the rear of the system)

1. **⚠ WARNING! Danger of a faulty release!**
To block the system: Switch the blocking switch (Fig. 86/arrow) to "Agent disconnect [blocked]" (Fig. 86/II).
2. **⚠ WARNING! Danger due to high voltage!**
Remove the mains lead.
3. Disconnect all connection lines from the system.

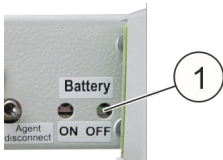

Fig. 87: Battery button

4. Actuate the battery button "Battery OFF" (Fig. 87/1).

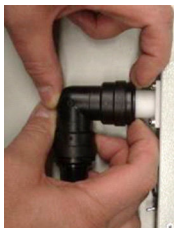

Fig. 88: Suction pipe

5. Disconnect the suction pipe from the system (Fig. 88).

6. ▶ Remove the system from the cabinet.
7. ▶ Place the system on a fixed, stable surface.
8. ▶ Loosen the screws on the front and rear cover.

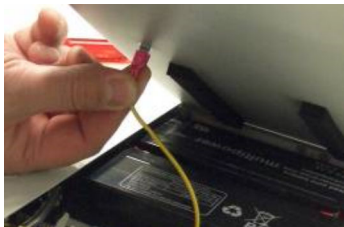

Fig. 89: Earthing plugs

9. ▶ Remove the earthing plugs from the front and rear cover (Fig. 89).

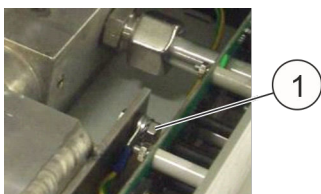

Fig. 90: Earthing screw

10. ▶ Remove the earthing screw (Fig. 90/1) from the tank.

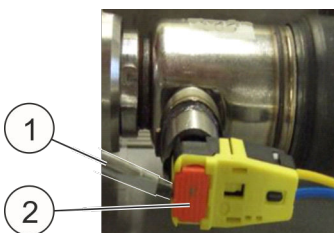

Fig. 91: Ignition plug

11. ▶ Push out the red arrest (Fig. 91/2) at the ignition plug with a small screwdriver (Fig. 91/1).
12. ▶ Pull out the ignition plug.

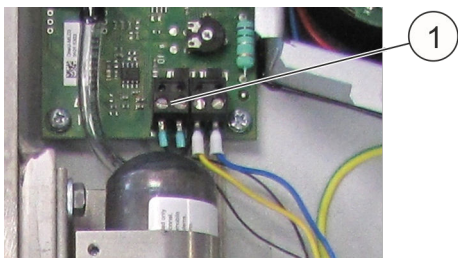

Fig. 92: Connection loss monitoring

13. ▶ Loosen the electrical connection (Fig. 92/1) of the loss monitoring.

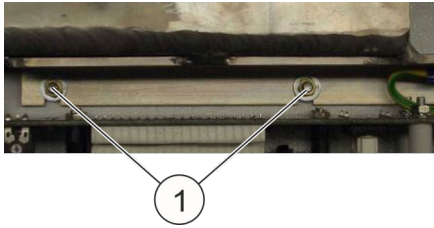

Fig. 93: Tank fastening

14. ➤ Remove the M3 nuts (Fig. 93/1) of the tank fastening with a 5.5 mm socket wrench.

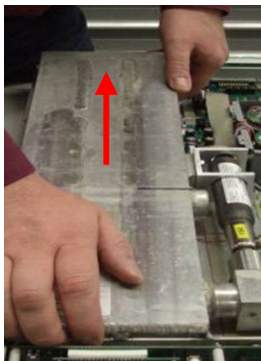

Fig. 94: Pulling out the tank

15. ➤ Lift up the tank in the rear section and carefully pull it out towards the rear (Fig. 94).

11.3.3 Disposal of the old tank and installation of a new tank





Fig. 95: Release unit

1. ➤ The release unit (Fig. 95) is labelled as "RELEASED" as it is a pyrotechnic element.
2. ➤ Dispose of the old tank in a proper and professional manner.

ⓘ The fastening material is not included in the scope of delivery of the new tank to be installed. Keep the fastening material if the new tank is not installed directly after the removal of the old tank.
3. ➤ **⚠ WARNING! Danger of a faulty release!**

Ensure that the blocking switch is set to "Agent disconnect [blocked]" before installing a new tank.
4. ➤ Install the new tank in the reverse order.

5.  Perform inspections and maintenance as per  *Chapter 11.2 “Inspection, maintenance and repairs by the Authorized Distributor” on page 100.*

11.4 **Firmware update**

A new Firmware update can be copied to the system using the Maintenance Program  *Chapter 10 “Maintenance program” on page 92.*

12 Spare parts, accessories, consumables, and tools

Systems	Part no.
DET-AC III Master	7338.121
DET-AC III Slave	7338.321
EFD III	7338.221

Spare parts	Part no.
Tank system/spare part, complete	914166
Battery, 12 V / 2.3 Ah, 2 units required	4003368
OMX6002 LS fire detector	4002679
OMX6002 HS fire detector	933629
50 µm infusion filter, complete	910516
0.315 A / 250 V fuse, micro fuse T	903147
1.8 kΩ end-of-line resistor (for door contact/manual call point)	675235
47R end-of-line resistor with 1N4007 rectifier diode for alarm device	917751
470 Ω, 1/2 W resistor (for door contact/manual call point)	675223
1K end-of-line resistor (for "RJ12 plug" door contact switch)	908119
22K end-of-line resistor (for "RJ12 plug" door contact switch)	906913
Mains connection cable, C13 – C14 / 2.5 m (8.2 ft) / 10 A / 250 V AC / 3×1.0 mm ² (3×AWG 18)	924861
Operating instructions (German)	916004
Operating instructions (English)	916005
AMX4003 insulating foil, 1 HE	906797
Lithium battery, 3 V	801436
"Gas-based extinguishing system – Danger to health" warning sign, German/English (for marking on the 19" cabinet)	933512
USB 2.0 cable, A-St to B-St	—

Permitted accessories	Part no.
Suction pipe system (22×2 pipe, plug connector, pipe clamps, etc.)	907061
Limit switch ZS 236-11z-2744, door contact (door contact switch)	889337
SONFL1X signaling device, red (horn and flashing light signaling device)	917453
DMX3000 manual call point, manual release, yellow	888845
Mains connection cable (with protective contact plug), 16 A / 250 V AC / 2.5 m (8.2 ft) / 3×1.0 mm ² (3×AWG 18)	906083

Permitted consumables	Part no.
Pipe clamp, \varnothing 19.5 to 23.5 mm (0.768 to 0.925 in)	906911
Tapping screw, BZ 5.5×13 [Rittal]	892350
Countersunk screw, ISO 14581 - M3×6 - 8.8 GAL ZN (cover)	915911
Pipe, 22×2 mm (outer diameter × wall thickness), black	906081
T-plug connector (22 mm)	906093
Angled plug connector (22 mm)	906094
Plug connector, straight (22 mm)	918033
Sealing plug (22 mm)	906096
Solo A3 test gas [from No Climb]	905904
Countersunk screw, DIN 965 - M3×8 - 5.8	684939
M6 oval head screw×16 (front panel)	607284

Tools	Part no.
Pipe cutter	905281
Torx TX10 wrench	---
Allen wrench, size 2.5 mm	---
Open-end wrench, size 8	---
Open-end wrench, size 19	---
Open-end wrench, size 22	---
Cross-head screwdriver for front panel screws	---
5.5 mm socket wrench for disconnecting the tank	---
Spirit level (for alignment)	---
Voltmeter (for power supply unit)	---

Software	Part no.
"Maintenance program" software	---

13 Final shutdown, disassembly, and disposal

After the end of the system's useful life has been reached, the system must be disassembled and disposed of in an environmentally appropriate manner.

13.1 Final shutdown and disassembly

- Personnel:
- Authorized Distributor
 - Qualified specialist personnel
- Protective equipment:
- Safety goggles
 - Safety gloves
 - Safety footwear

INFORMATION

The final shutdown and disassembly of the system must be entrusted to an Authorized Distributor or service personnel authorized by the Authorized Distributor. Contact can be established through the manufacturer, see page 2.

WARNING

Danger due to incorrect decommissioning and disassembly!

Improper decommissioning or disassembly may lead to dangerous situations resulting in severe injuries and significant property damage.

- Have decommissioning and disassembly performed only by an Authorized Distributor or service personnel authorized by the Authorized Distributor.
 - Do not carry out unauthorized decommissioning and disassembly.
-

13.2 Disposal

- Personnel:
- Authorized Distributor
 - Qualified specialist personnel
- Protective equipment:
- Safety goggles
 - Safety gloves
 - Safety footwear

INFORMATION

The system may be disposed of only by the Authorized Distributor or service personnel authorized by the Authorized Distributor.

NOTICE

Danger to the environment due to incorrect disposal!

Incorrect disposal can cause dangers for the environment.

- Entrust only the Authorized Distributor or service personnel authorized by the Authorized Distributor with the disposal of the system and its components.
 - Do not allow unauthorized disposal.
-

Upon request, the manufacturer will handle the return and proper disposal of the batteries within the European Union.

14 Technical data

Installation dimensions	19", 44 mm (1.73 in.) [1 RU], 660 mm (26 in.) mm deep (depth above everything)
Housing material	Sheet metal
Weight	Approx. 15.5 kg (34.17 lb.)
Nominal voltage	100 ... 240 V AC, 50/60 Hz
Emergency power supply	Approx. 4 hr
Maximum battery internal resistance	1200 mOhm
Maximum permissible active current	1.0 A at 24 volts (the sum of all the connected devices must not exceed the permissible active current of 1.0 A)
Maximum permissible charge current	350 mA at 24 volts
Power supply unit load currents:	
I_{maxa} / I_{maxb}	1.3 A
I_{min}	Approx. 100 mA
Ambient temperature	+10 °C ... +40 °C (+50 °F ... +104 °F) [operating] -20 °C ... +65 °C (-4 °F ... +149 °F) [storage without batteries] -15 °C ... +40 °C (+5 °F ... +104 °F) [storage of batteries]
Humidity	Up to 96% relative, non condensing
Protection type	IP 30

Connections	<ul style="list-style-type: none"> ● Connecting terminal for relay output “Pre-alarm”; max.: 30 V / 0.5 A / ohmic load ¹⁾ ● Connecting terminal for relay output “Fire alarm”; max.: 30 V / 0.5 A / ohmic load ¹⁾ ● Connecting terminal for relay output “Extinguishing”; max.: 30 V / 0.5 A / ohmic load ¹⁾ ● Connecting terminal for relay output “Common failure”; max.: 30 V / 0.5 A / ohmic load ¹⁾ ● Plug (RJ12) for door contact switch connection ● Door contact plug 2 ● 3 × (RJ12) connection plugs to Rittal CMC I/O Unit (failure, main alarm, pre-alarm) ● 2 × CAN connection for networking ● External alarm equipment, maximum 500 mA ● Connection of external fill level monitoring and triggering of external tank (only EFD III), max. 500 mA ● Manual call point plug ● Power supply (UB), max. 500 mA ● USB port (type B) ● CAN bus for networking to the various Rittal monitoring systems <p>¹⁾ ↪ Chapter 6.3.1 “Potential-free contacts” on page 52</p>
Displays	<ul style="list-style-type: none"> ● 1 display with plain text display of state messages ● 1 green “Operation” LED ● 1 yellow “Shutdown” LED ● 1 red “Extinguishing system triggered” LED ● 1 red “Extinguishing system released” LED ● 1 yellow “Blocked” LED ● 1 yellow “Failure” LED
Sensor system (2 different scattered light sensors for 2 alarm thresholds)	<ul style="list-style-type: none"> ● Optical fire detector LS (sensitivity: approx. 2.73 %/m light obscuration) ● Optical fire detector HS (HS = highly sensitive) (sensitivity: approx. 0.34 %/m light obscuration)
Suction pipe	Adhesive-free connector system, black (outer diameter: 22 mm, inner diameter: 18 mm)
Suction bores	↪ Chapter 6.2.5.1 “Establishing the suction bores” on page 44
Air flow monitoring	Approx. +/-10 % of the total air flow current
Protection volume	Maximum 2.8 m ³ (98.9 ft ³) the protection volume must not exhibit any recognizable openings

External devices	<ul style="list-style-type: none"> ● Connection for manual call point ● Connection for door contact ● CAN bus connection for networking with various Rittal monitoring systems ● Connection for networking (RJ12-DEC) "DET-AC III Master - DET-AC III Slave"
Tank	<p>Material: aluminum</p> <p>Empty volume: approx. 2.0 liter (0.53 US liq. gal.)</p> <p>Contents: approx. 1.8 liter (0.48 US liq. gal.) FK-5-1-12 (3M™ Novec™ 1230)</p> <ul style="list-style-type: none"> ● Extinguishing agent discharge from pressure charging via propellant cartridge integrated electrical release unit ● Integrated extinguishing agent loss / fill level monitoring (display of > 15 % loss)

15 Index

1, 2, 3 ...

19" cabinet 10

A

Accessories 12, 116

Additional device 51

Addressing 59

Air flow 48

 Calibration 48, 70, 73

Alarm 64

Alarm device 85

 External 33, 53

Alarm function

 Checking 48

AMEM 94

Application zone 15

Assembly 35

AT3 30

Authorized Distributor 22, 35

B

Battery 10

 Change 83

 State 84

Battery button 38

BIOS 77

Blocking 55

Blocking switch 38

Buttons 67

C

Cabinet 10

Cabinets

 Several 47

Card

 AT3 connection technology 30

 NW network interface 30

Cartridge 10

Caution 14

Changes

 Structural 16

Checks 99

CMC 32, 54

Combination

 Systems 58

Compatibility

 Systems 58

Configuration 59

Connections 30

Consumables 117

Contact

 potential-free 52

Control card 10

CPU3 10

D

Data line 61

Date 70, 71

Decommissioning 118

Decomposition products 17

Detector interface 10

Disassembly 118

Discharge nozzle 10

Display 68

Disposal 119

Distributor

 Authorized 22

DMEM 94

Door contact 55

Door contact switch 31, 47, 49

 RJ12 plug 56

Door opening

 Automatic 31, 47, 56

Dust 37

E		
Effects of cold	18	
EMEM	94	
Emergency power supply	10	
Environmental protection	23, 119	
Event memory	70, 72, 94	
Extinguishing agent container	10	
Extinguishing zone		
Marking	23	
F		
Failure	64	
Failure function		
Checking	48	
Fan	10	
Faulty release	17	
Fill level monitoring	10, 33, 54	
Filter	10, 83	
Fire	24	
Fire detectors	10, 50	
Fire safety		
Lack of fire safety	99	
Fire smoke	17	
Firmware	77, 94	
FK-5-1-12	10	
Function of the system	28	
Functional test	38	
I		
Ignition plug	111	
Incorrect use	15	
Information	14	
Inside temperature	70, 77, 86	
Inspection	101	
Installation position	37	
Installation steps	38	
Instruction	20	
Instructions		
Warnings in	14	
Integration time	76	
Intended use	15	
Interface NW	30	
L		
Lamp test	70, 77	
Language	92	
Language setting	42	
LEDs	67	
Limitations of liability	12	
M		
Maintenance	70, 81, 101	
Maintenance program	92	
Manual call point	33, 49, 63	
Marking	23	
Messages	88	
Misuse	15	
Monitoring system	32, 54	
N		
Network cabinet	10	
Network interface card	30	
Networking	34, 58, 62	
Noise	18	
Notice	14	
Novac	10, 15	
O		
Operating hours counter	87	
Operation		
Maintenance program	97	
Safe operation	16	
Overview	10	
Owner	21	
Owner's obligations	21	
P		
Packaging	27	
PDU	10, 12, 54	

Power supply	10, 34	Switch cabinets	
Project	94	Several	47
Propellant cartridge	10, 111	Symbol	14
Protective equipment	20	System	
Q		State	62
Qualification	18	Systems	116
Qualification of personnel	18	T	
R		Tank	10, 54
Re-ignition	37	Change	111
Relay outputs	31	Extern	33
Repairs	101	Temperature	70, 77, 86
Report	20	Temperature indicator	42
Residual risks	16	Time	70, 71
Return transport	26	Tools	117
Revision	70, 80	Transport	25, 26
RJ12 plug	56	Inspection	25
S		U	
Safety	14	USB port	34
Safety instructions	14	Use	15
Safety notice	14	V	
Scope of delivery	11	Version	77
Serial number	77	Version query	70
Server cabinet	10	W	
Shock	17	Warning	14
Shutdown	37	Warning notice	14
Signs	23	Wire cross section	30
Smoke	37		
Software	117		
Spare parts	16, 116		
Structural changes	16		
Structure of the system	28		
Suction bore	43, 45		
Suction pipe	45, 46		
System	43		
Switch	31		
Switch cabinet	10		

Rittal – The System.

Faster – better – everywhere.

- Enclosures
- Power Distribution
- Climate Control
- IT Infrastructure
- Software & Services

Operating Instructions / DET-AC III Master / 916005 / 11-2022 / en_US



You can find the contact details of all Rittal companies throughout the world here.



www.rittal.com/contact

ENCLOSURES

POWER DISTRIBUTION

CLIMATE CONTROL

IT INFRASTRUCTURE

SOFTWARE & SERVICES

