

Kumanda konsolu üst kısmı

Genişlik 600/800 mm
TP 6720.500, TP 6721.500

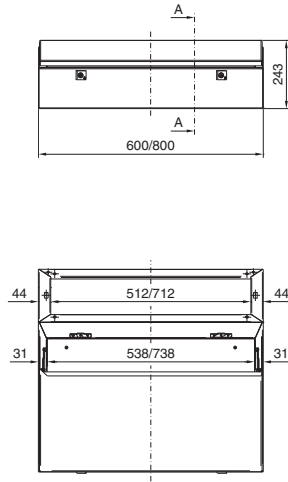

Genişlik 1200/1600 mm
TP 6722.500, TP 6723.500

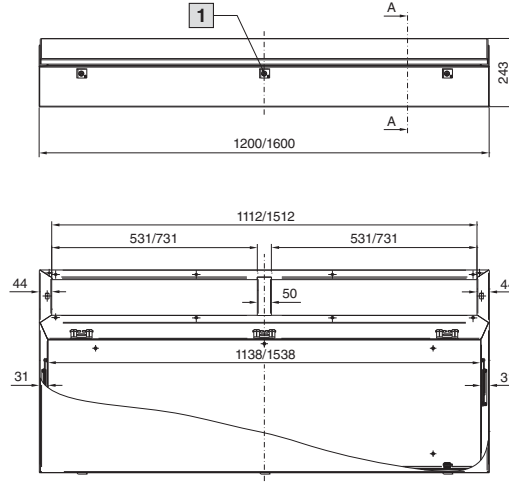

Kesit A – A

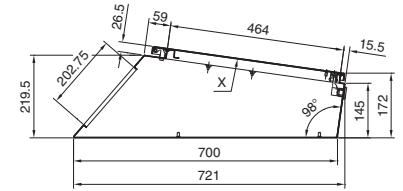

1 Yalnızca 1600 mm genişliğinde

Not:
– X görünümü, bkz. sayfa 2

Kumanda konsolu orta kısmı, kumanda konsolu üst kısım için hazırlanmış

Genişlik 600/800 mm
TP 6714.500, TP 6715.500

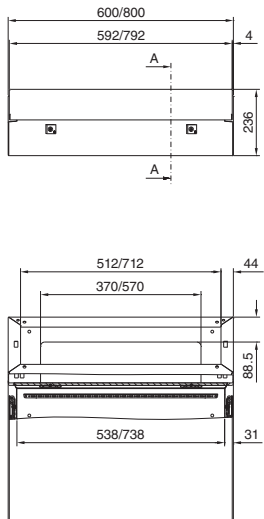

Genişlik 1200/1600 mm
TP 6716.500, TP 6717.500

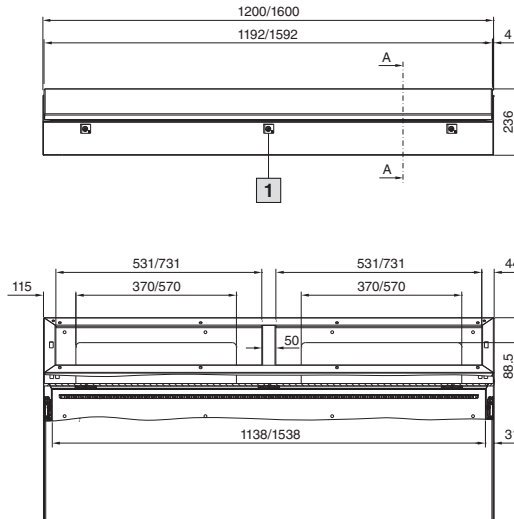

Kesit A – A

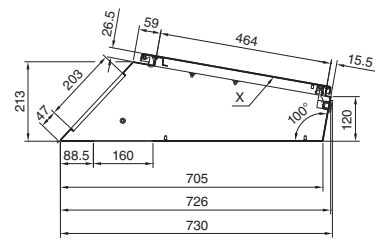

1 Yalnızca 1600 mm genişliğinde

Not:
– X görünümü, bkz. sayfa 2

Endüstriyel panolar

TopPult sistemi TP

Kumanda konsolu orta kısmı, arkadan menteşeli kapak

Genişlik 600/800 mm
TP 6710.500, TP 6711.500

Genişlik 1200/1600 mm
TP 6712.500, TP 6713.500

Kesit A – A

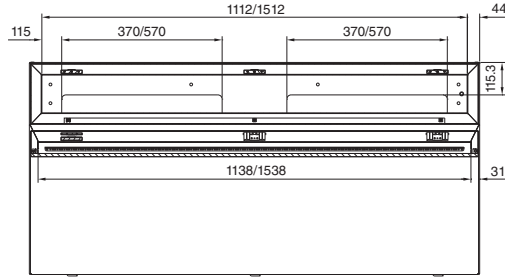
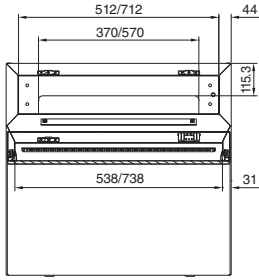
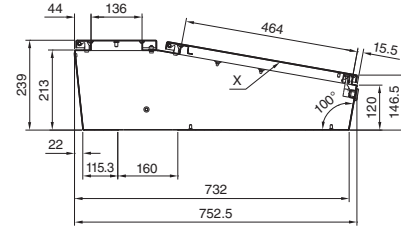
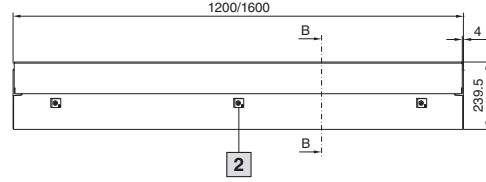
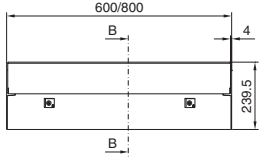

X görünümü

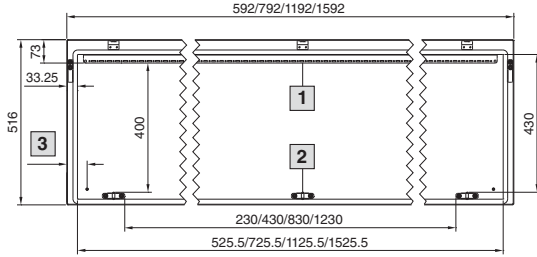

- 1 600/800 mm genişliğinde bulunmaz
- 2 Yalnızca 1600 mm genişliğinde
- 3 Genişlik = 600/800/1200 = 63,5 mm
Genişlik = 1600/163,5 mm

Kumanda konsolu alt kısmı, derinlik 400 mm

Genişlik 600/800 mm
TP 6700.500, TP 6701.500

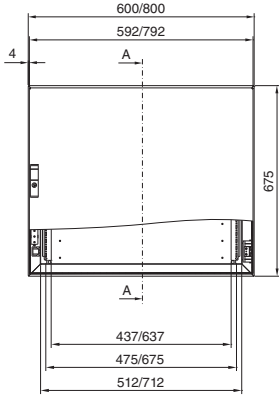

Genişlik 1200/1600 mm
TP 6702.500, TP 6703.500

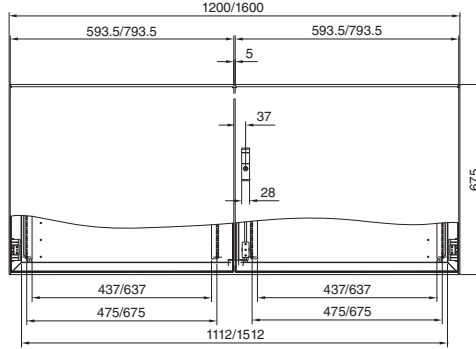

Kesit A – A

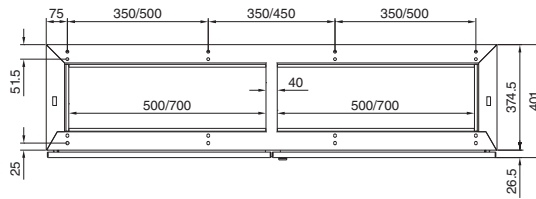
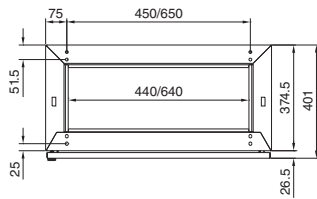
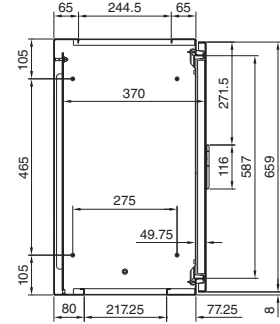

Montaj kesiti

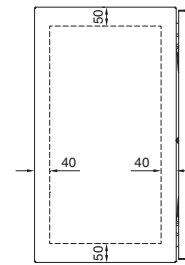

Montaj plakası

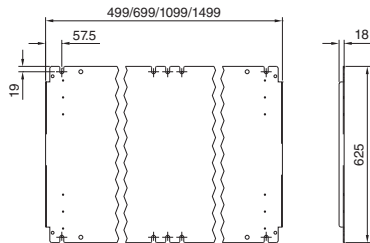

Endüstriyel panolar

TopPult sistemi TP

Kumanda konsolu alt kısmı, derinlik 500 mm

Genişlik 600/800 mm
TP 6704.500, TP 6705.500

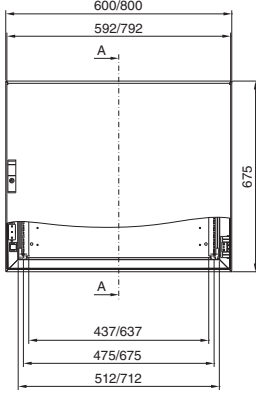

Genişlik 1200/1600 mm
TP 6706.500, TP 6707.500

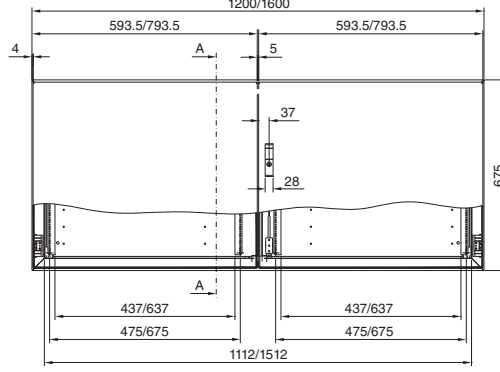

Kesit A – A

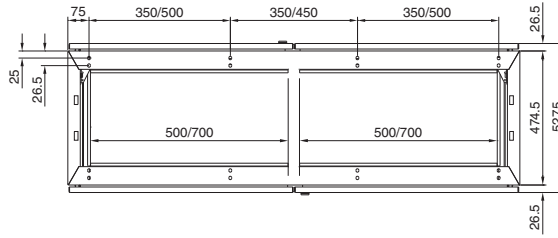
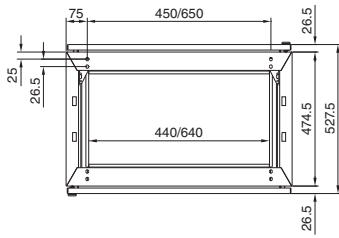
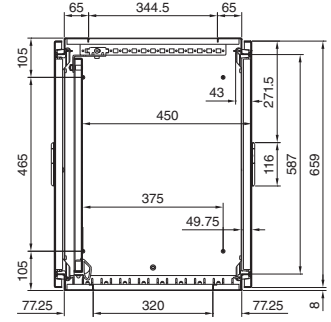

Montaj kesiti

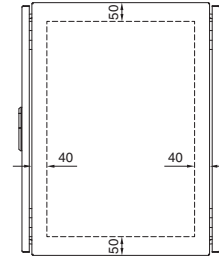

Montaj plakası

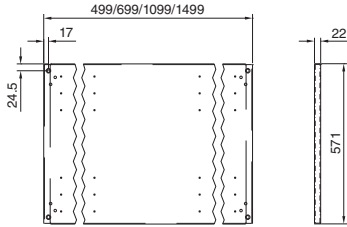

Kombinasyon seçenekleri

3 parçalı kurulum

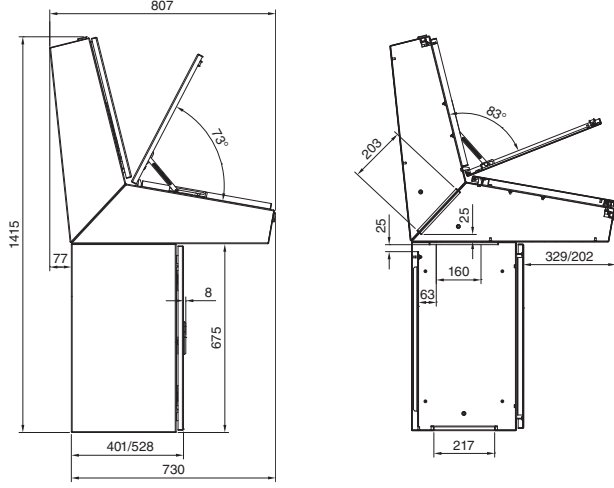

2 parçalı kurulum

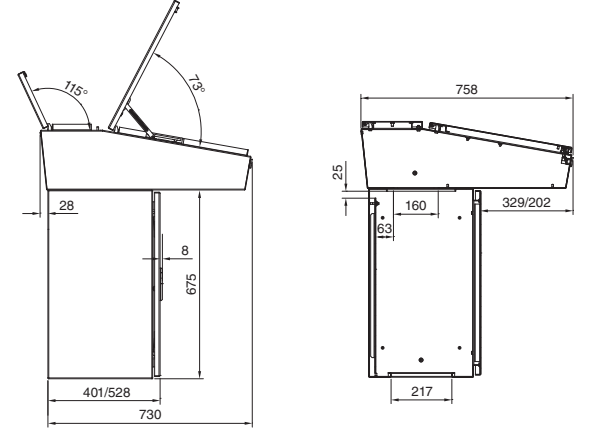

1 parçalı kurulum

