

Rittal – The System.

Faster – better – everywhere.



**TopTherm LCP Rack CW
TopTherm LCP Inline CW
TopTherm LCP Inline flush CW**

3311.130/230/260
3311.530/560
3311.540

**Montage-, Installations- und Bedienungsanleitung
Assembly and operating instructions
Notice d'emploi, d'installation et de montage
Montage- en bedieningshandleiding**

ENCLOSURES

POWER DISTRIBUTION

CLIMATE CONTROL

IT INFRASTRUCTURE

SOFTWARE & SERVICES

FRIEDHELM LOH GROUP



Foreword

Dear Customer!

Thank you for choosing a Rittal Liquid Cooling Package (referred to hereafter also as "LCP").

This documentation applies to the following three units in the LCP series:

- LCP Rack CW
- LCP Inline CW
- LCP Inline flush CW

Those sections where information only applies to one of the three units are labelled accordingly in the documentation.

Please take the time to read this documentation carefully.

Please pay particular attention to the safety instructions in the text and to section 2 "Safety instructions".

This is the prerequisite for:

- secure assembly of the Liquid Cooling Package
- safe handling and
- the most trouble-free operation possible.

Please keep the complete documentation readily available so that it is always on hand when needed.

We wish you every success!

Your,
Rittal GmbH & Co. KG

Rittal GmbH & Co. KG
Auf dem Stützelberg

35745 Herborn, Germany
Germany

Tel.: +49(0)2772 505-0
Fax: +49(0)2772 505-2319

E-mail: info@rittal.de
www.rimatrix5.com
www.rimatrix5.de

We are always happy to answer any technical questions regarding our entire range of products.

Contents

1	Notes on documentation	5	5.3	Fan installation	27
1.1	CE labelling	5	5.3.1	Removing a fan module	28
1.2	Storing the documents	5	5.3.2	Installing a fan module	30
1.3	Symbols in these operating instructions	5	5.4	Install the optional display (3311.030)	31
1.4	Other applicable documents	5	6	Installation	32
1.5	Normative instructions	5	6.1	Connecting the Liquid Cooling Package	32
1.5.1	Legal information concerning the operating instructions	5	6.1.1	Electrical connection	32
1.5.2	Copyright	5	6.1.2	Cooling water connection	35
1.6	Software update	5	6.1.3	Connecting the condensate discharge	38
2	Safety instructions	6	6.1.4	Bleeding the air from the heat exchanger	39
2.1	Important safety instructions:	6	6.2	Cooling operation and control characteristics	39
2.2	Service and technical staff	7	7	Commissioning checklist	40
2.3	RoHS compliance	7	8	Configuration	42
3	Device description	8	8.1	General	42
3.1	General functional description	8	8.2	HTTP connection	42
3.2	Ambient conditions	9	8.2.1	Making the connection	42
3.3	Air routing	11	8.2.2	Changing the network settings	42
3.3.1	General	11	8.2.3	Changing the measurement units	43
3.3.2	LCP Rack	11	8.2.4	LCP configuration	43
3.3.3	LCP Inline and LCP Inline flush	12	8.2.5	Settings	46
3.4	Equipment assembly	12	9	Operation	47
3.4.1	Schematic design	12	9.1	Description of operating and display components	47
3.4.2	Unit components	13	9.1.1	Control unit hardware for the Liquid Cooling Package	47
3.4.3	Air/water heat exchanger	15	9.2	Description of operation	48
3.4.4	Fan module	15	9.2.1	General	48
3.4.5	Water module with cold water connection	16	9.2.2	Acknowledging messages	48
3.5	Proper and improper usage	16	9.2.3	Operation in stand-alone mode	49
3.6	Supply scope of a Liquid Cooling Package	17	9.2.4	Automatic door opening, LCP Rack	52
3.7	Unit-specific instructions	17	9.3	Extended options by connecting the Liquid Cooling Package to a network	53
3.7.1	Creation of redundancy in the LCP Rack	17	9.4	General operation	53
3.7.2	Dewpoint control	19	9.4.1	Layout of screen pages	53
4	Transportation and handling	20	9.4.2	Navigation area in left-hand section	54
4.1	Transportation	20	9.4.3	Index tabs in the configuration area	54
4.2	Unpacking	20	9.4.4	Message display	54
5	Assembly and siting	21	9.4.5	Other displays	55
5.1	General	21	9.4.6	Changing parameter values	56
5.1.1	Installation site requirements	21	9.4.7	Logging off and changing the password	57
5.1.2	Prepare the room for installation of the LCP Inline and LCP Inline flush	21	9.4.8	Reorganising the connected components	57
5.1.3	Installation regulations for the LCP Inline and LCP Inline flush	22	9.5	Observation index tab	58
5.2	Assembly procedure	23	9.5.1	Device	58
5.2.1	General	23	9.5.2	Air	59
5.2.2	Dismantle the side panels	23	9.5.3	Water	60
5.2.3	Seal the server enclosure	23	9.5.4	Config	63
5.2.4	Dismantle the server enclosure door	24	9.6	Configuration index tab	63
5.2.5	Fit the rear adaptor on the LCP Inline	25	9.7	Virtual devices	64
5.2.6	Fit the trim panels if siting without a rear adaptor	26	9.7.1	Creating a virtual device	64
5.2.7	Installation and baying of the Liquid Cooling Package	26	9.7.2	Configuring the output	64
5.2.8	Mounting the side panel	27	9.7.3	Configuring a virtual device	64
			9.7.4	Access configuration	65
			9.8	Tasks	66

Contents

EN

10	Updates and data backup	67
11	Troubleshooting	68
11.1	General faults.....	68
11.2	Messages on the display.....	70
12	Inspection and maintenance	71
13	Storage and disposal	72
14	Technical specifications	73
14.1	30 kW versions	73
14.1.1	LCP Rack and LCP Inline	73
14.1.2	LCP Inline flush	74
14.2	55 kW versions	75
15	Spare parts	77
16	Accessories	78
17	Further technical information	79
17.1	Hydrological information.....	79
17.2	Tables and characteristic curves	80
17.2.1	Cooling output, 30 kW versions	80
17.2.2	Cooling output, 55 kW versions	82
17.2.3	Pressure loss	83
17.3	Overview drawings.....	85
17.4	Circuit diagram.....	87
17.4.1	Control unit hardware for the fan modules (RLCP fan)	89
17.4.2	Control unit hardware for the water module (RLCP water)	90
17.4.3	Hardware for startup current limitation	91
17.5	Water circulation diagram.....	91
18	Preparation and maintenance of the cooling medium	92
19	Frequently Asked Questions (FAQ) .	93
20	Glossary	99
21	Customer service addresses	100

1 Notes on documentation

1.1 CE labelling

Rittal GmbH & Co. KG hereby confirms that the cooling units in the Liquid Cooling Package series are compliant with the EC EMC Directive 2004/108/EC. A corresponding declaration of conformity has been issued and enclosed with the documentation package supplied with the unit.

The cooling unit bears the following mark.



1.2 Storing the documents

The assembly and operating instructions as well as all applicable documents are integral components of the product. They must be handed out to those persons who are engaged with the unit and must always be available and on hand for operating and maintenance personnel.

1.3 Symbols in these operating instructions

The following symbols are found in this documentation:



Danger!
Hazardous situation which causes death or serious injury if the instructions are not followed.



Warning!
Hazardous situation which may lead to death or serious injury if the instructions are not followed.



Caution!
Hazardous situation which may lead to (minor) injuries if the instructions are not followed.



Note:
Information concerning individual procedures, explanations, or tips for simplified approaches. Also indicates situations which may result in material damage.

- This symbol indicates an "Action Point" and shows that you should carry out an operation/procedure.

1.4 Other applicable documents

In conjunction with these assembly and operating instructions, the superordinate system documentation (if available) also applies.

Rittal GmbH & Co. KG is not responsible for any damage which may result from failure to comply with these assembly and operating instructions. The same applies to failure to comply with the valid documentation for accessories used.

1.5 Normative instructions

1.5.1 Legal information concerning the operating instructions

We reserve the right to make changes in content. Rittal GmbH & Co. KG will not be held liable for any mistakes in this documentation. Liability for indirect damages which occur through the delivery or use of this documentation is excluded to the extent allowable by law.

1.5.2 Copyright

The distribution and duplication of this document and the disclosure and use of its contents are prohibited unless expressly authorised.

Offenders will be liable for damages. All rights created by a patent grant or registration of a utility model or design are reserved.

1.6 Software update

These instructions have revision level 4A from February 11, 2015 and apply to software version V3.15.00.

This documentation shows the English screenshots. The descriptions of individual parameters on the Liquid Cooling Package website also use the English terminology. Depending on the set language, the displays on the Liquid Cooling Package website may be different (see assembly and operating instructions for the CMC III PU 7030.000).

2 Safety instructions

EN

2 Safety instructions

The Liquid Cooling Packages produced by Rittal GmbH & Co. KG are developed and produced with due regard to all safety precautions. Nevertheless, the unit still causes a number of unavoidable dangers and risks. The safety instructions provide you with an overview of these dangers and the necessary safety precautions.

In the interest of your safety and the safety of others, please read these safety instructions carefully before assembly and commissioning of the Liquid Cooling Package.

Follow the user information found in these instructions and on the unit carefully.

2.1 Important safety instructions:



Danger! Electric shock!

Contact with live electrical parts may be lethal.

Before switching on, ensure that it is not possible to come into contact with live electrical parts.

The unit has a high discharge current. For this reason, it is essential to make a 10 mm² earth connection before connecting to the supply circuit (see section 17.4 "Circuit diagram").



Danger! Injury caused by fan impellers!

Keep persons and objects away from the fan impellers! Do not remove covers until the power supply is disconnected and impellers are not moving! Always use mechanical protection when working! Shut down the respective fan during maintenance work, if possible! Tie long hair back! Do not wear loose clothing! Fans start up automatically following power disruptions!



Danger! Cut wounds, especially through sharp edges of the fan and heat exchanger modules!

Put on protective gloves before beginning assembly or cleaning work!



Danger! Injury due to falling loads!

Do not stand under suspended loads when transporting the unit with a hoist trolley, a forklift, or a crane.



Caution! Risk of malfunction or damage! Do not modify the unit! Use only original spare parts!



Caution! Risk of malfunction or damage! Proper and flawless unit operation can only be ensured when it is operated under the intended ambient conditions. As far as possible, be sure that the ambient conditions for which the unit is designed are complied with, e.g. temperature, humidity, air purity.



Caution! Risk of malfunction or damage! All media necessary for the control system, e.g. cooling water, must be available during the entire operating time.



Caution! Risk of malfunction or damage! It is vital that the manufacturer's consent is obtained before adding anti-freeze!



Caution! Risk of malfunction or damage! During storage and transportation below freezing point, the water cycle should be drained completely using compressed air!



Caution! Risk of malfunction or damage! Only set the temperature control set-point as low as is strictly necessary, since the danger of condensation through undercutting the dew point increases with a falling water inlet temperature!

Ensure that the enclosure is sealed on all sides, particularly at the cable entry (condensation)!

As a general requirement, please observe the following five safety rules to DIN VDE 0105 when working in and on the Liquid Cooling Package, in order to avoid accidents:

1. Switch off!
Switch off the Liquid Cooling Package at the master switch.
2. Prevent reactivation!
3. Ensure that all poles are de-energised!
4. Earth and short-circuit!
5. Cover or shield adjacent, live parts!

2.2 Service and technical staff

The installation, commissioning, maintenance and repair of this unit may only be carried out by qualified mechanical and electro-technical trained personnel.

Only properly instructed personnel may perform service on a unit while in operation.

2.3 RoHS compliance

The Liquid Cooling Package fulfils the requirements of EU directive 2002/95/EC on the Restriction of Use of Certain Hazardous Substances in Electrical and Electronic Equipment (RoHS) of 13 February, 2003.



Note:

Corresponding information concerning the RoHS directive is provided by our firm on the Internet at www.rittal.de/RoHS.

3 Device description

EN

3 Device description

3.1 General functional description

The Liquid Cooling Package is essentially an air/water heat exchanger that is used to dissipate high heat losses from server enclosures or for the effective cooling of devices built into a server enclosure.

The air routing in the Liquid Cooling Package supports the "front to back" cooling principle of the devices built into the server enclosure. The hot air expelled by the devices in the server enclosure is drawn in by the fans at the rear directly from the server enclosure (LCP Rack) or from the hot aisle (LCP Inline and LCP Inline flush) and thus routed through the heat exchanger module.

In the heat exchanger module, the heated air is directed through an air/water heat exchanger, and its thermal energy (heat losses from the server) is transferred to a cold water system. As a result, the air is cooled to a freely selectable temperature within the authorised parameters and then routed directly in front of the 482.6 mm (19") level in the server enclosure (LCP Rack) or into the cold aisle (LCP Inline and LCP Inline flush).

In its delivered state, the LCP Inline expels the cold air on both sides. By fitting a side panel or partition, this can be restricted to one side only.

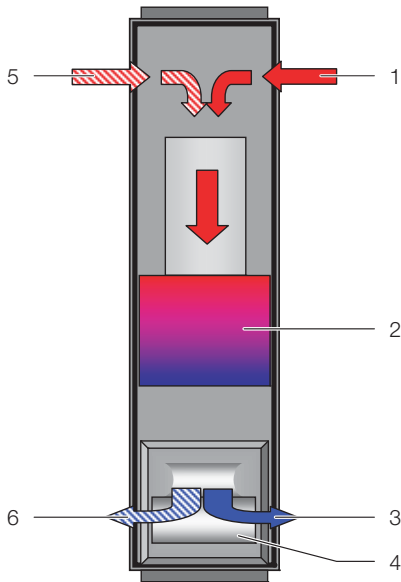

Fig. 1: Air routing on the LCP Rack – top view

Key

- 1 Air inlet
- 2 Heat exchanger
- 3 Air outlet
- 4 Fan module
- 5 2nd air inlet
- 6 2nd air outlet

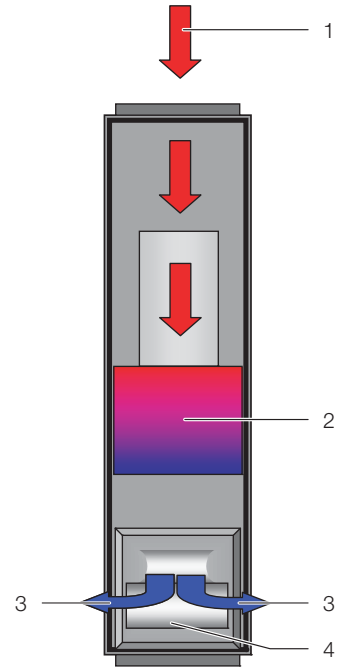

Fig. 2: Air routing on the LCP Rack – top view

Key

- 1 Air inlet
- 2 Heat exchanger
- 3 Air outlet
- 4 Fan module

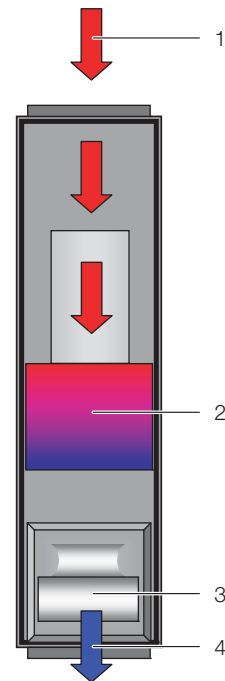

Fig. 3: Air routing on the LCP Inline flush – top view

Key

- 1 Air inlet
- 2 Heat exchanger
- 3 Fan module
- 4 Air outlet

The temperature of the cold air intake is controlled via constant comparison of the actual temperature with the setpoint temperature set on the Liquid Cooling Package control unit (default is +20°C).

If the server-in temperature exceeds the setpoint temperature, the control valve in the cooling water system opens (linear opening from 0 – 100%), and the heat exchanger is supplied with cold water.

The temperature differential between the setpoint and the warm air that is drawn is used to determine and set the fan speed. The control unit attempts to keep the air temperature constant in front of the 482.6 mm (19") level (LCP Rack) or in the cold aisle (LCP Inline and Inline flush) by activating the control valve.

Any condensate incurred is collected in the condensate collecting tray built into the water module of the Liquid Cooling Package, and from there is routed outside via a condensate discharge hose.



Note:

The water inlet temperature must always be selected (controlled) to be above the dew point for the existing ambient temperature and humidity in the data centre. The dew point can be found in the Mollier h-x diagram (fig. 4).

Furthermore, we advise compliance with the ASHRAE standard "ASHRAE TC 9.9, 2011 Thermal Guidelines for Data Processing Environments".

3.2 Ambient conditions

The Liquid Cooling Package is used to dissipate the thermal load generated by IT equipment and prevent the installation site of the IT equipment from overheating. If IT systems are operated at excessive ambient temperatures, this may lead to malfunctions and restricted operation of the system. The correct system temperature is based on manufacturer-specific information. The Liquid Cooling Packages only dissipate the thermal loads from the IT equipment, but not the thermal loads produced by lighting and other heat sources; these must be dissipated by other air-conditioning systems. In data centres, the air-conditioning systems are responsible for air quality. Where defined requirements apply to relative humidity at the installation site for the operation of IT equipment, the most efficient way of achieving this is via the air-conditioning system.

Depending on the ambient conditions, generally speaking it is advisable to regulate the intake air supplied to the data centre via an air-conditioning system. This prevents the formation of condensation on the heat exchanger due to an excessively hot or damp air supply to the data centre. If it is imperative to work with inlet temperatures below the dew point, the fresh air supply must likewise be regulated via an air-conditioning system.

If the air-conditioning system in the data centre is compliant with VDI 6022 (hygiene requirements for air-conditioning systems and devices), ventilation and dehumidification of the intake air to the air-conditioning system can be achieved more efficiently and hygienically than with direct IT cooling using a Liquid Cooling Package.

If there is a central air-conditioning system for basic climate control installed in the data centre, when planning an LCP cooling system to dissipate the thermal loads, the following information must be available:

- Relative humidity of the room air (intake air) in %
- Room air temperature (intake air temperature) in °C
- Cold water system temperature (where available)



Note:

ASHRAE (American Society of Heating, Refrigerating and Air-Conditioning Engineers) recommends server intake air temperatures of between 18°C and 27°C. The selected server intake air temperature should be agreed with the manufacturer of the IT equipment and the operator at the project planning stage.

Based on the prescribed conditions, please use the Mollier h-x diagram to check whether cooling at the prescribed cold water temperature will fall below the dew point (fig. 4 "Mollier h-x diagram for humid air").

The blue markings in the Mollier h-x diagram give an example of how to calculate the dew point for the following conditions:

- Room temperature: 22°C
- Relative humidity: 50%

This produces a dew point of 11°C.

Sensitive and latent cooling output

If the surface temperature of the heat exchanger in the Liquid Cooling Package is below the dew point, condensation will form on the heat exchanger. This leads to cooling output losses, since the energy is only used for condensation (latent cooling output).

On the other hand, if working with cold water temperatures where the surface temperature of the heat exchanger is above the dew point, the energy is only used to cool the server intake air (sensitive cooling output).

Section 6.1.2 "Cooling water connection" describes a tried-and-tested hydraulic circuit which quickly and easily supplies the required volume of water at the correct temperature.

3 Device description

EN

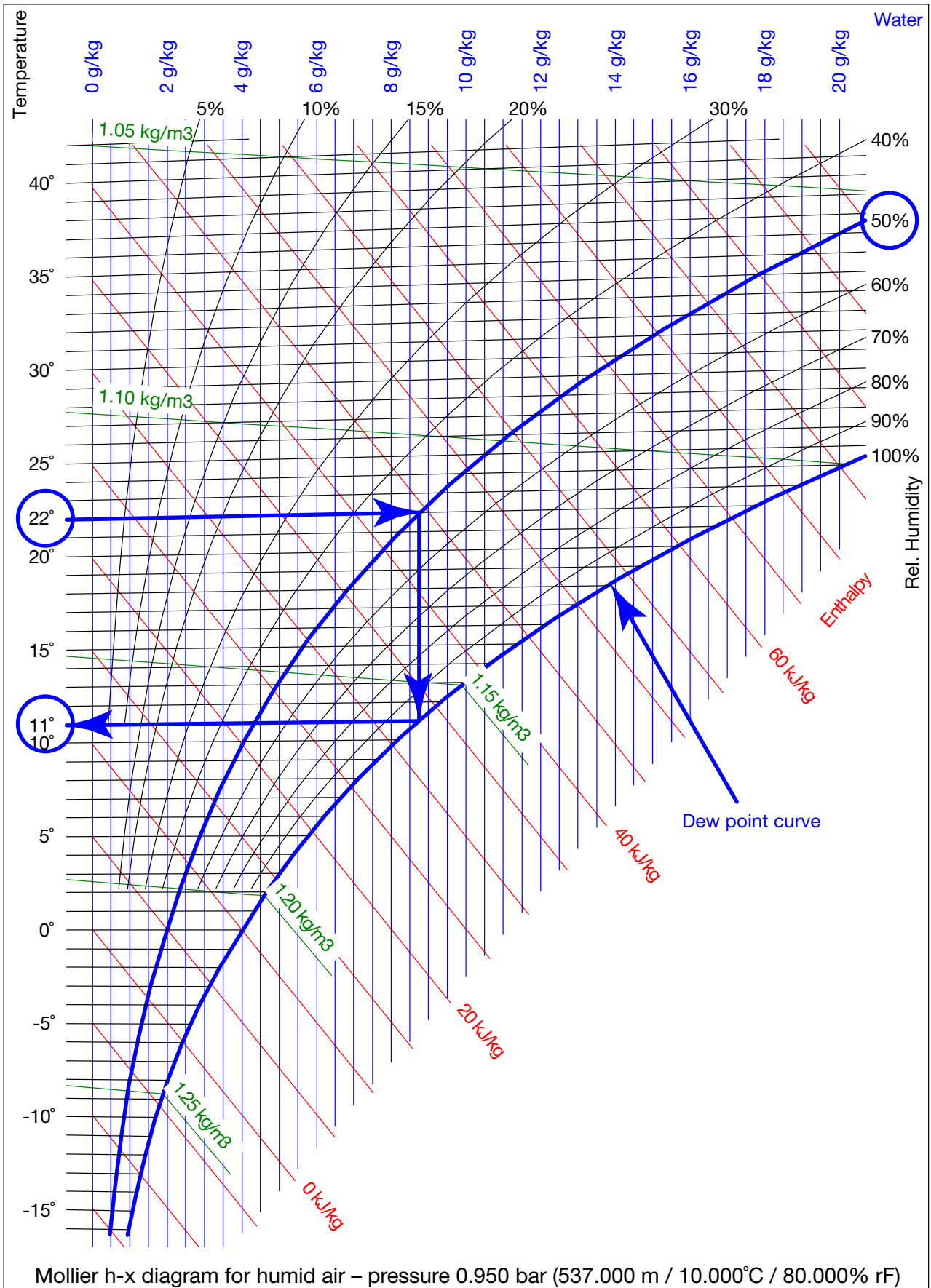

Fig. 4: Mollier h-x diagram for humid air

3.3 Air routing

3.3.1 General

In order to achieve sufficient cooling in the server enclosure, it is important to ensure that the cooling air passes through the interior of the built-in units and is unable to flow past at the sides.

Targeted air routing in the server enclosure has a major effect on the heat loss to be dissipated.

In order to ensure targeted air routing in the system, the server enclosure should be divided vertically into warm air and cold air sections. The division is accomplished in the front section of the server assembly to the left and right of the 482.6 mm (19") level using foam strips or air baffle plates which, depending on the enclosure width and the number of server enclosures to be cooled, can be ordered as an accessory (see section 16 "Accessories").

If devices which require sideways air throughput are built into the server enclosure (e.g. switches, router, etc.), these may be cooled through targeted placement of the foam strips or air baffle plates.



Note:

The 482.6 mm (19") level must likewise be completely sealed. This is already the case in a fully equipped server enclosure. If the server enclosure is partially equipped, the open height units (U) of the 482.6 mm (19") level must be sealed with blanking plates, which are available from Rittal Accessories (see section 16 "Accessories").

As more devices are installed in the server enclosure, it becomes even more important to follow this specification.

3.3.2 LCP Rack

The LCP Rack may be bayed on the right or left of a server enclosure, according to preference.

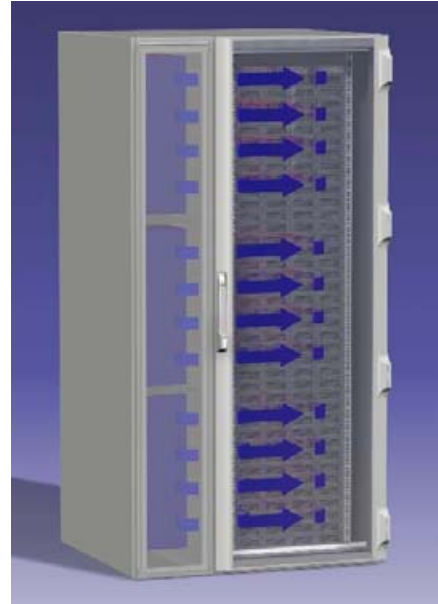

Fig. 5: LCP Rack on a server enclosure

The LCP Rack may also be bayed between two server enclosures.



Fig. 6: LCP Rack on two server enclosures

Together with the bayed server enclosure, the LCP Rack forms an airtight cooling system with horizontal air routing. It places no additional demands on the room's climate control system.

3 Device description

EN

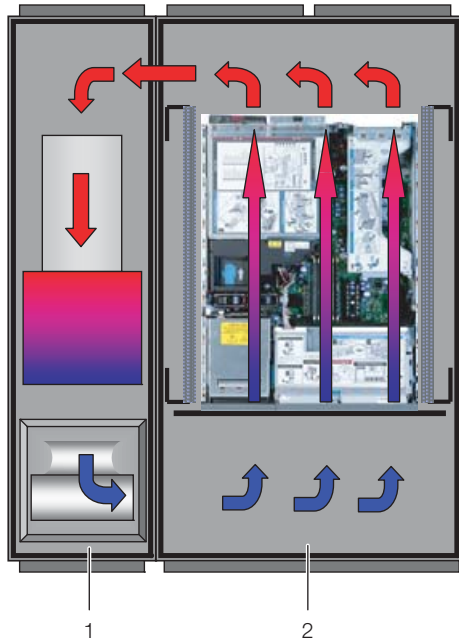

Fig. 7: Air routing with a bayed server enclosure – top view

Key

- 1 LCP Rack
- 2 Server enclosure

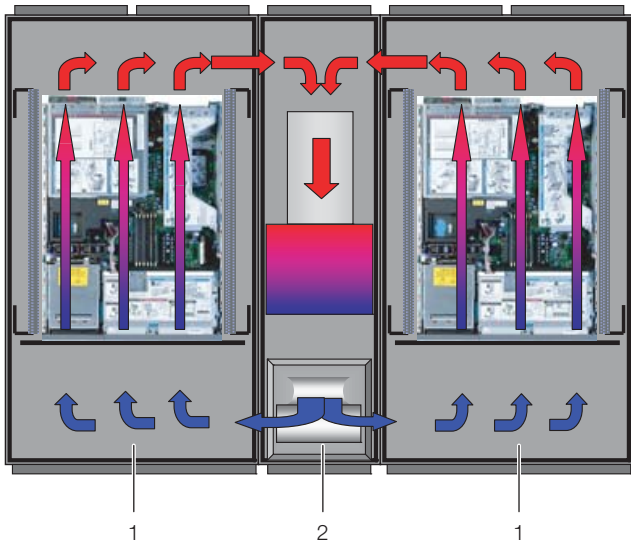

Fig. 8: Air routing with two bayed server enclosures – top view

Key

- 1 Server enclosure
- 2 LCP Rack

The system consisting of the LCP Rack and the server enclosure should be sealed as effectively as possible in order to prevent the loss of cooling air. To accomplish this, the enclosure is equipped with side panels, roof and gland plates. Any existing cable entries should be sealed e.g. using suitable brush strips.

Whilst the system is in operation, both the front and the rear doors should be kept completely shut.



Note:

However, the system does not need to be completely airtight, thanks to the high, coordinated air throughputs of the server and LCP fans.

3.3.3 LCP Inline and LCP Inline flush

Targeted air routing by hot air extraction from the hot aisle and cold air blown into the cold aisle has a fundamental effect on the amount of heat to be dissipated.

In order to achieve sufficient cooling in the server enclosure, it is important to ensure that the cooling air passes through the interior of the built-in units and is unable to flow past at the sides.

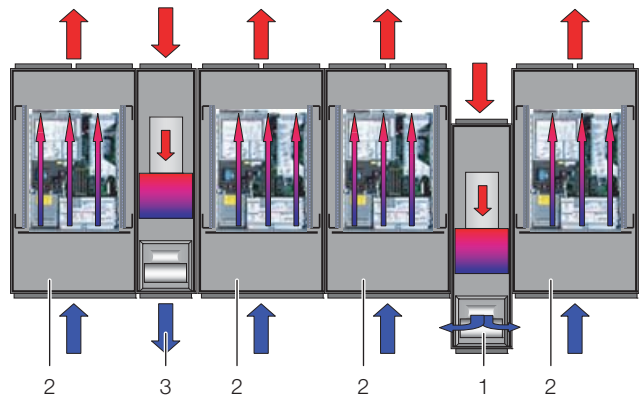

Fig. 9: Air routing with bayed server enclosures – top view

Key

- 1 LCP Inline
- 2 Server enclosure
- 3 LCP Inline flush

For this purpose, the system consisting of LCP Inline or LCP Inline flush, server enclosure and cold aisle containment should be sealed as effectively as possible in order to avoid a decrease in cooling capacity due to mixing of cold and hot air. This is achieved by sealing the cold aisle with doors at the beginning and end of the rack rows, and sealed against the ceiling with roof elements. Existing cable entry glands are additionally sealed e.g. with suitable brush strips.

3.4 Equipment assembly

3.4.1 Schematic design

The schematic design is illustrated below:

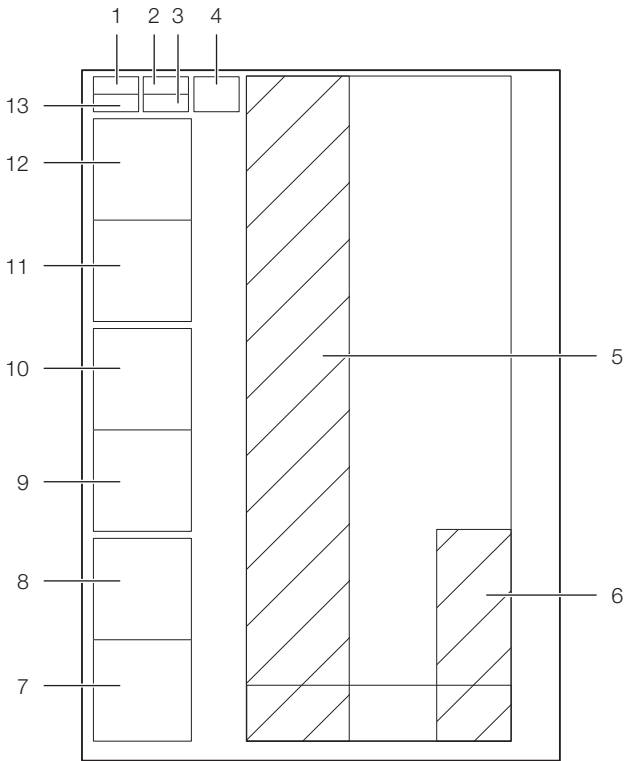

Fig. 10: Schematic design of a Liquid Cooling Package – right-hand side view

Key

- 1 Fuse box with master switch (see fig. 11, item 6)
- 2 Water PCB
- 3 Fan PCB
- 4 Startup current limitation
- 5 Air/water heat exchanger
- 6 Water module
- 7 Fan 6 (not with LCP Inline flush)
- 8 Fan 5 (not with LCP Inline flush)
- 9 Fan 4
- 10 Fan 3
- 11 Fan 2
- 12 Fan 1
- 13 Control unit CMC III PU (see fig. 11, item 5)

The Liquid Cooling Package consists of a fuse box, a superordinate control unit (CMC III PU), a water module, a heat exchanger, and the fan modules. In its supplied state, the following fan modules are built into the devices:

Device/cooling output	30 kW	55 kW
LCP Rack	1 module	4 modules
LCP Inline	1 module	4 modules
LCP Inline flush	2 modules	–

Tab. 1: No. of fan modules in supplied state

The fan modules and the water module contain their own electronic controls (1 x RLCP fan and 1 x RLCP water), which are connected to the CMC III PU via a CAN bus. The fan modules are switched on sequentially from

one to six (or one to four with LCP Inline flush) via a start-up current limitation once connected to the mains voltage.

3.4.2 Unit components

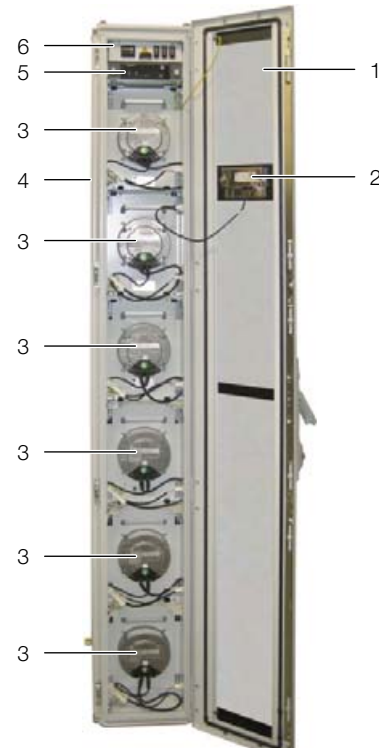

Fig. 11: Liquid Cooling Package front – open front door (55 kW variant)

Key

- 1 LCP door
- 2 Optional display with touch function (rear)
- 3 Fans (in this instance, fully equipped with 6 fans)
- 4 Rack
- 5 Control unit CMC III PU (see fig. 10, item 13)
- 6 Fuse box with master switch (see fig. 10, item 1)

3 Device description

EN

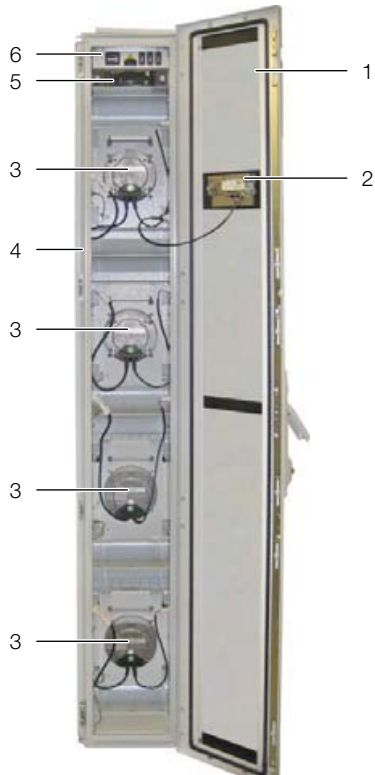

Fig. 12: LCP Inline flush front – open front door

Key

- 1 LCP door
- 2 Installation location for optional display with touch function
- 3 Fans (in this instance, fully equipped with 4 fans)
- 4 Rack
- 5 Control unit CMC III PU (see fig. 10, item 13)
- 6 Fuse box with master switch (see fig. 10, item 1)

The fuse box is comprised of the following components:

- Thermally activated master switch
- 3 thermally activated switches for fan pairs 1/2, 3/4 and 5/6
- AC/DC power pack for CMC III PU supply
- EMC line filter



Fig. 13: Fuse box with master switch

Key

- 1 Thermally activated switch, fan pair 1/2
- 2 Thermally activated switch, fan pair 3/4
- 3 Thermally activated switch, fan pair 5/6
- 4 Thermally activated master switch

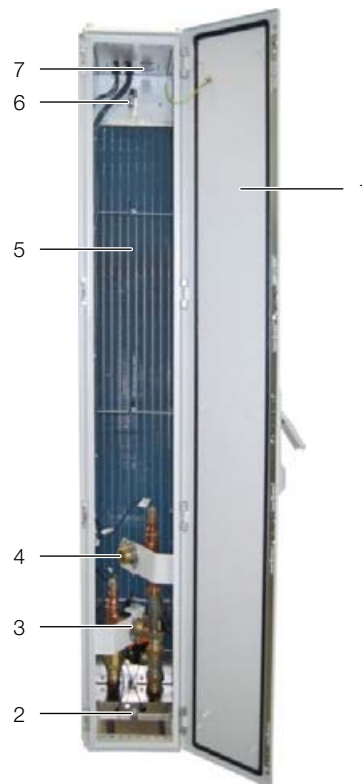

Fig. 14: LCP Rack rear – rear door open

Key

- 1 LCP rear door
- 2 Condensate collecting tray and condensate discharge
- 3 Water connection, return
- 4 Water connection, inlet
- 5 Air/water heat exchanger
- 6 Vent valve
- 7 Mains connection, network connection and connection of optional condensate pump



Note:

In principle, the rear of the LCP Inline and the LCP Inline flush looks exactly the same as the LCP Rack, except that they have a perforated door.

The Liquid Cooling Package consists of a solid welded frame in which the heat exchanger, fan modules, and the water module are installed.

One wide and one narrow wall plate are mounted on both the left and right sides.

The wall plates have been punched with air outlet openings along their entire height in the front section to ensure cold air supply to the server (LCP Rack) or to the cold aisle (LCP Inline).

In the LCP Rack, the wall plates in the rear section have been punched with air inlet openings along their entire height and width to ensure the dissipation of warm air from the server.

Seven shelves (or in the case of the LCP Inline flush, five shelves) are positioned between these wall plates that divide the front of the Liquid Cooling Package into several compartments of differing heights. The top shelf supports the fuse box, the control unit (CMC III PU), the fan and water PCB, and the startup current limitation. The compartments for the fans are below this. All components of the cooling water supply and condensate management are integrated into the water module on the floor of the Liquid Cooling Package.

The front and rear of the Liquid Cooling Package are each closed with a door with 4-point locking.

In the LCP Rack these doors seal the unit. In the LCP Inline and LCP Inline flush, the rear door is perforated to ensure the dissipation of hot air from the hot aisle. In the LCP Inline flush, the front door is additionally perforated to ensure the supply of cooling air into the cold aisle.

The optional display with touch function for operation in stand-alone mode is located on the front.

3.4.3 Air/water heat exchanger

The air/water heat exchanger is installed in the centre section of the Liquid Cooling Package between the two wall plates. In 30 kW units (3311.130/230/530/540), the heat exchanger is covered with a spray eliminator on the air outlet side that catches any condensate and directs it to the condensate collecting tray at the bottom of the Liquid Cooling Package.

Three temperature sensors are mounted on the rear of the spray eliminator at the level of the fan modules. The sensors record the temperature of the cold air intake and send it to the control unit.

3.4.4 Fan module

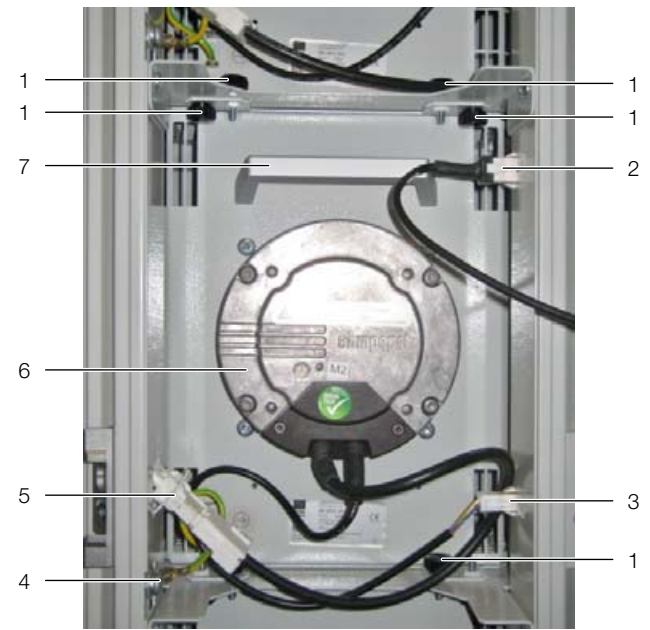

Fig. 15: Fan module in fan tray – LCP Inline and LCP Rack version

Key

- 1 Knurled screws/Hex screws
- 2 Connection cable for display with touch function
- 3 Connector DC
- 4 Earth connection
- 5 Connector AC
- 6 Fan
- 7 Handle

3 Device description

EN



Fig. 16: Fan module in fan tray – LCP Inline flush version

Key

- 1 Air baffle plate
- 2 Connector DC
- 3 Earth connection
- 4 Fan
- 5 Handle
- 6 Connector AC
- 7 Knurled screws/Hex screws

A fan module is essentially comprised of the fan itself. All fan modules are controlled by a shared control unit (RLCP fan) which is mounted in the upper section of the Liquid Cooling Package. The fans may be operated with linear control from 0%–100%.

The fan modules are installed on rack-mounted shelves in the front section of the Liquid Cooling Package.

The two connection cables for the power supply and pilot wire are routed out of the underside of the fan. In the LCP Rack and LCP Inline, the intake end of the fan module lies against a sealing section mounted on the left and right of the rack, which forms an effective seal. In the LCP Inline flush, the fans lie directly against the rack. This means that in the installed state, the fans are connected directly to the unit's air/water heat exchanger, enabling the air from the air/water heat exchanger to be routed directly and without interruption to the fan module.

It takes about 2 minutes to replace a fan module during operation (see section 5.3 "Fan installation").

3.4.5 Water module with cold water connection

A significant component of the water module is the stainless steel condensate collecting tray, on which a leak sensor and a condensate discharge are located. In addition to the leak sensor, the condensate tray is also equipped with a pressureless condensate discharge.

This directs the condensate out of the Liquid Cooling Package to the rear. The hose must be connected to an external discharge (see section 6.1.3 "Connecting the condensate discharge").

The pipework for the Liquid Cooling Package's cooling water connection (inlet and return) runs above the condensate collecting tray.

The lines connect the rear-mounted cooling water connection with the air/water heat exchanger built into the front of the device. The lines are insulated to avoid the formation of condensation. A motorised control valve is located in the cooling water inlet line to control the cooling water flow.

The control unit of the water module is fitted in the upper section, below the power supply to the Liquid Cooling Package.

The cooling water connection is connected to the main inlet and return connections by two 1½" externally threaded pipes for flange gaskets. The connection nozzles are positioned horizontally to the rear.

The cooling water connection to the cold water network can be made by either rigid pipework or flexible hoses, which are available from the Rittal accessory range (Model No. 311.040).

3.5 Proper and improper usage

The Liquid Cooling Package is used to dissipate high heat losses and effectively cool devices built into a server enclosure. The unit is designed solely for stationary use in sealed rooms.

The unit is state of the art and built according to recognised safety regulations. Nevertheless, improper use can present a hazard to life and limb of the user or third parties, or result in possible damage to the system and other property.

Consequently, the unit must only be used properly and in a technically sound condition.

Any malfunctions which impair safety should be rectified immediately. Follow the operating instructions!

Proper use also includes following the operating instructions and fulfilling the inspection and maintenance conditions.

Inappropriate use may result in danger. Inappropriate use may include:

- Use of impermissible tools.
- Improper use.
- Improper rectification of malfunctions.
- Use of replacement parts which are not authorised by Rittal GmbH & Co. KG.
- Failure to observe the required water quality.

- Use of a coolant other than water.
- Expelling the cold air into an air duct system.
- Use in an industrial environment.
- Non-stationary use, e.g. on moving or vibrating machines.

3.6 Supply scope of a Liquid Cooling Package

The Liquid Cooling Package supply includes:

Qty.	Parts
1	Liquid Cooling Package, ready for connection
	Accessories:
1	Condensate hose
1	Vent hose
1	Sealing strip
1	Connector
2	Cable ties and spreading anchors (strain relief for connection cables)
2	Jumpers for connection plug
1	Assembly instructions

Tab. 2: Supply scope of a Liquid Cooling Package

3.7 Unit-specific instructions

3.7.1 Creation of redundancy in the LCP Rack

Cooling redundancies are easily achieved via the previously described baying possibilities. Separation of the server enclosure from the Liquid Cooling Package makes it possible to achieve differing levels of redundancy.

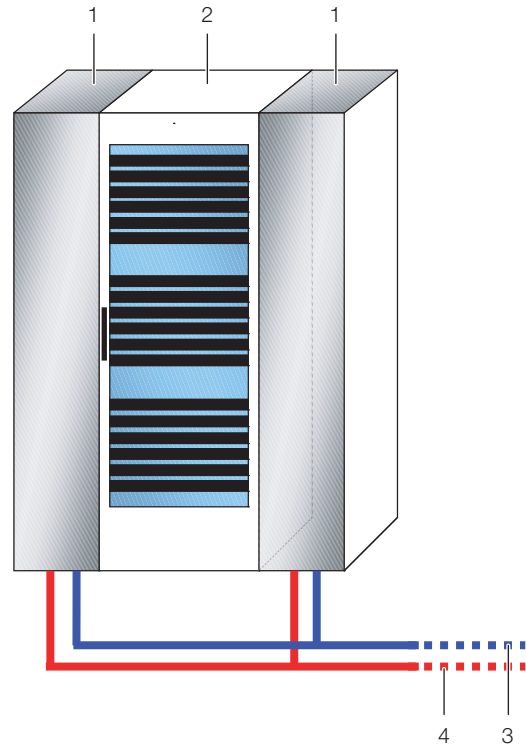

Fig. 17: Redundant or double cooling with two LCP Racks

Key

- 1 LCP Rack
- 2 Server enclosure
- 3 Cold water system inlet
- 4 Cold water system return

Two server enclosures may be cooled with 3 LCP Racks. Depending on the cooling output, the device bayed in the middle, between the server enclosures, forms the redundancy for the respective left and right server enclosure.

3 Device description

EN

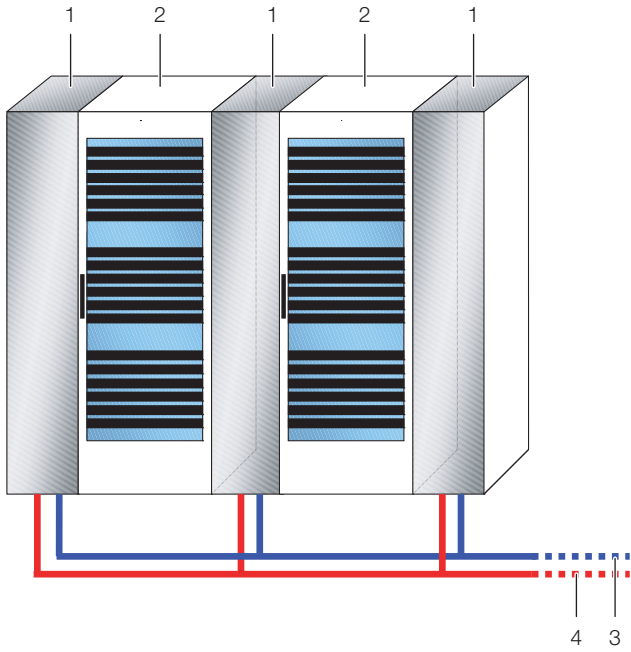

Fig. 18: Redundant cooling with three LCP Racks

Key

- 1 LCP Rack
- 2 Server enclosure
- 3 Cold water system inlet
- 4 Cold water system return

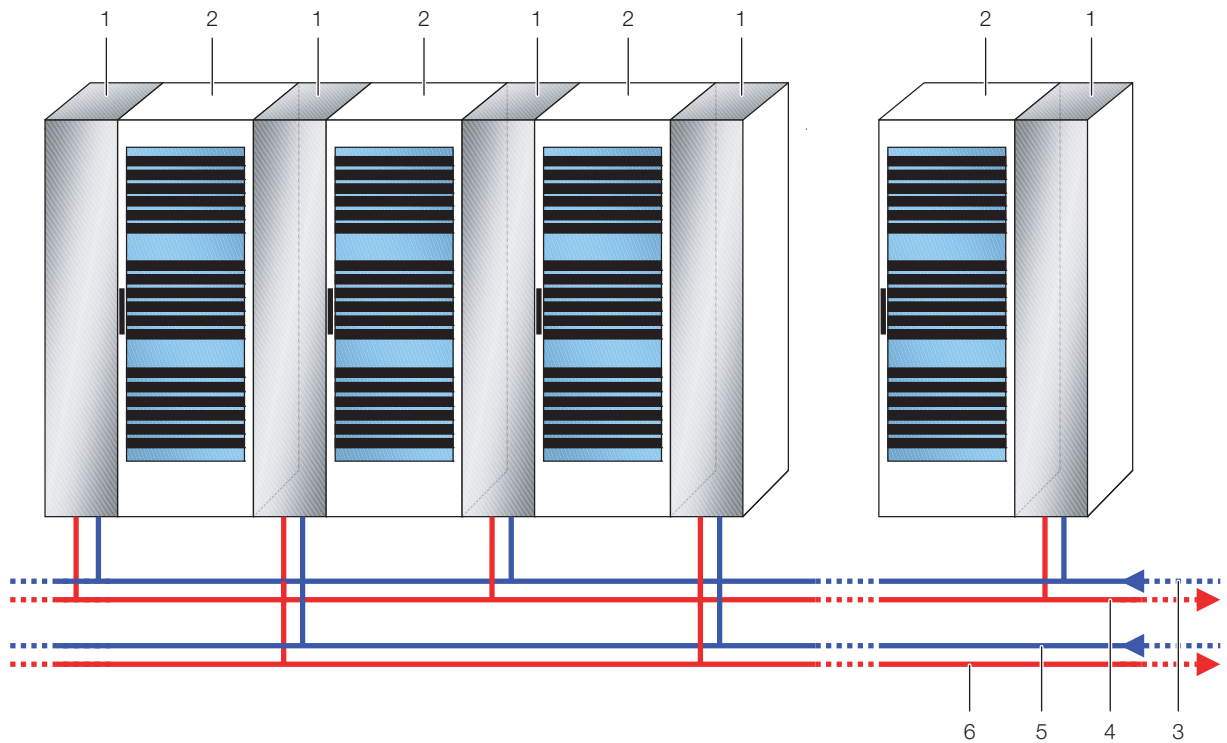

Fig. 19: Redundant cooling and double alternating water supply

Key

- 1 LCP Rack
- 2 Server enclosure
- 3 Cold water system inlet 1
- 4 Cold water system return 1
- 5 Cold water system inlet 2
- 6 Cold water system return 2

3.7.2 Dewpoint control

A dewpoint control must be installed on the LCP Inline (3311.530/560), the LCP Inline flush (3311.540) and on the 55 kW version of the LCP Rack (3311.260).

This form of control depends on the components and settings of the complete facility and therefore varies from case to case. If there already is a cooling unit that controls the air humidity of the room, additional dewpoint control is not necessary in the majority of cases, since this cooling unit already regulates the humidity according to the recommendations of the ASHRAE standard "ASHRAE TC9.9, 2011 Thermal Guidelines for Data Processing Environments". If the dew point is to be regulated by the LCP Inline or the LCP Inline flush itself, there are two regulation types available with the same additional scope of installations. First, a temperature/humidity sensor (7030.111) needs to be installed into the outlet side of the LCP Inline or LCP Inline flush. It is easily mounted on the TS 8 frame and effortlessly connected to the CMC III PU of the LCP Inline or LCP Inline flush. The alert triggering range for a humidity of $\leq 95\%$ should then be set via the web interface (see assembly and operating instructions of the CMC III Processing Unit 7030.000 or the sensor).

The following can be selected in the "Tasks" section in case of an alarm: either the fans are switched off (Attention! Cooling capacity is no longer guaranteed), or the integrated regulating valve is closed, thereby raising the temperature of the heat exchanger above the dew point. These solutions may, however, cause a failure or decrease in cooling capacity.

The facility must have an independent dew point monitor if you do not opt for internal control.

A dew point regulator installed in the plant mainly depends on the way in which the LCP Inline or LCP Inline flush is supplied with cold water.

Generally speaking, the dew point monitor should be installed on the outlet side of the unit. Upon approaching the dew point, it must be capable of raising the inlet temperature of the cold water or deactivating the cooling via a controller.

4 Transportation and handling

EN

4 Transportation and handling

4.1 Transportation

The Liquid Cooling Package is delivered shrink-wrapped on a pallet.



Caution!

Because of its height and small base, the Liquid Cooling Package is subject to tipping. Risk of toppling, especially after the unit is removed from the pallet!



Caution!

**Transport of the Liquid Cooling Package without a pallet:
Use only suitable and technically sound lifting gear and load-bearing devices with sufficient load capacity.**

4.2 Unpacking

- Remove the unit's packaging materials.



Note:

After unpacking, the packaging materials must be disposed of in an environmentally friendly way. They are comprised of the following materials:

Wood, polyethylene film (PE film), strap, edge protectors.

- Check the unit for any damage that occurred during transport.



Note:

Damage and other faults, e.g. incomplete delivery, should immediately be reported to the shipping company and to Rittal GmbH & Co. KG in writing.

- Place the unit in its intended location.

5 Assembly and siting

5.1 General

5.1.1 Installation site requirements

LCPs are cooling units for IT equipment. Please observe the following general remarks on the installation site:

- The installation site of the LCPs must be adequately protected from external weather conditions.
- The installation room should be sealed in order to avoid uncontrolled air exchange with the environment.
- The fresh air supply should be reduced to a minimum, in accordance with generally recognised technical regulations.
- If the intake air to the installation room is cooled by an air-conditioning system, be sure to tailor the relative air humidity to the water inlet temperature of the LCPs. This avoids condensation and ensures maximum energy efficiency (see section 3.2 "Ambient conditions").

In order to ensure problem-free operation of the Liquid Cooling Package, the following conditions for the installation location should be observed:

Supply connections required at the installation site per Liquid Cooling Package

Type of connection	Connection description:
Power connection:	230 V, 1~, 50/60 Hz 20 A, 1~ 400 V, 3~, N, PE, 50/60 Hz with connection cable 7856.025 16 A, 3~, CEE connector, 5-pole
Cooling water connection:	15°C inlet temperature 6 bar permissible operating pressure Volumetric flow: depending on design (see section 17.2 "Tables and characteristic curves") DN 40 (on-site)

Tab. 3: Supply connections required at the installation site



Note:

Please see the notes and data regarding the cold water connection in section 6.1.2 "Cooling water connection" and in section 17.2 "Tables and characteristic curves".



Recommendation:

For easier servicing of the Liquid Cooling Package, maintain a distance of at least 1 m between the front and rear of the device and the nearest wall.

Floor conditions

- The floor of the installation space should be rigid and level.
- Choose the installation site so that the unit is not situated on a step, unlevel location, etc.

Climatic conditions

As per the technical specifications (see section 14 "Technical specifications"), the air temperature at the installation site of the Liquid Cooling Package must be between +6°C and +35°C.



Recommendation:

Room temperature +22°C at 50% relative air humidity, according to ASHRAE guidelines.

Electromagnetic interference

- Interfering electrical installations (high frequency) should be avoided.

5.1.2 Prepare the room for installation of the LCP Inline and LCP Inline flush

The installation site of the LCP Inline and LCP Inline flush must be divided into one cold air zone and one hot air zone. This ensures that no cooling capacity is lost due to mixing of cold and hot air.

5 Assembly and siting

EN

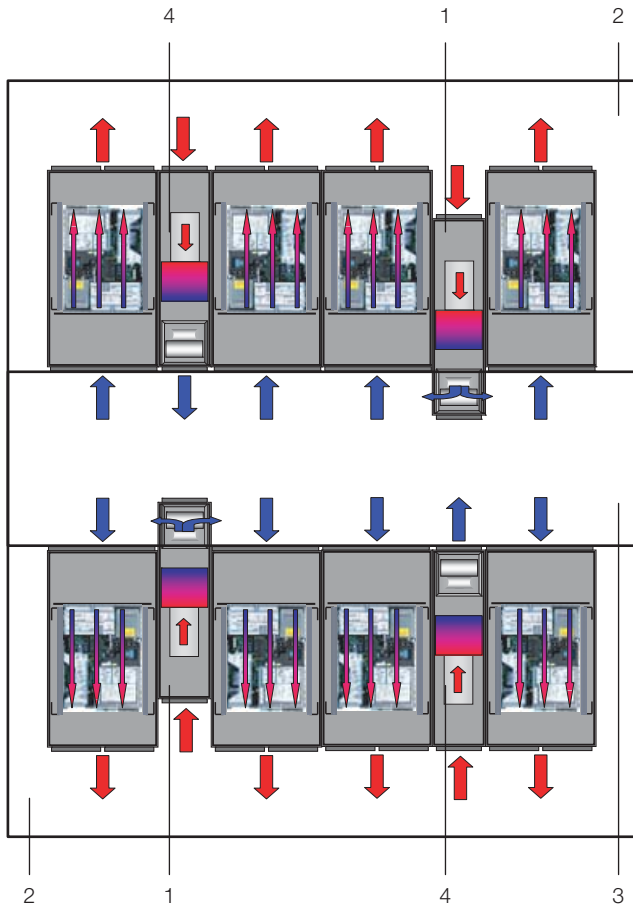

Fig. 20: Installation room with cold aisle compartmentalisation

Key

- 1 LCP Inline
- 2 Hot aisle
- 3 Cold aisle
- 4 LCP Inline flush



Note:
All components required to install suitable cold aisle containment are available from Rittal as accessories.

5.1.3 Installation regulations for the LCP Inline and LCP Inline flush

The positioning in the rack aisles must be considered when planning the layout. The following points are to be considered:

- Heat loss in the adjacent server racks
- Air throughput in the adjacent server racks
- Distances from the adjacent server racks

Heat losses in the adjacent server racks

If the LCP Inline or LCP Inline flush is used in combination with server racks with high heat losses, the number of LCP Inline or LCP Inline flush units must be adapted according to the characteristic curves (see section 6.2 "Cooling operation and control characteristics"). The air temperature difference between server inlet and server

outlet, which is determined by the equipment used, is of particular interest. As a rule of thumb, a temperature difference of 15 K can be expected. There may, however, be greater differences.

Air throughput in the adjacent server racks

Due to the containment of the hot and cold zones, it is important to ensure that the LCP Inline or LCP Inline flush delivers a sufficient amount of cold air into the cold zone. From there, the cold air is drawn back into the server enclosures by the equipment. A small surplus of air should generally be provided in order to compensate for any short-term demands of the equipment.

Distances from the adjacent server racks

In small applications and short aisles, the above points will not have a major impact on properties or cooling capacity provided the hot zone is thoroughly sealed off from the cold zone. For larger applications and long aisles, however, even distribution of the cooling units should be ensured, due to the loss of air throughput caused by pressure changes and convection or radiation heat of the equipment. Other factors, such as high-temperature rooms adjacent to the cold zone or exterior walls warmed by the sun, can also occur.

As a general rule, the prescribed minimum and maximum distances between LCP units and between the first LCP unit and the wall of the aisle containment must be observed. Furthermore, when siting the equipment, it is important to observe the relevant escape route planning requirements. For this reason, the units must **not** be positioned directly opposite one another.

Distances	minimum [m]	maximum [m]
LCP – external wall Fig. 21, item 1	0.6	1.6
LCP – LCP Fig. 21, item 2	1.2	3.2
Side offset Fig. 21, item 3	0.3	–

Tab. 4: Minimum and maximum distances

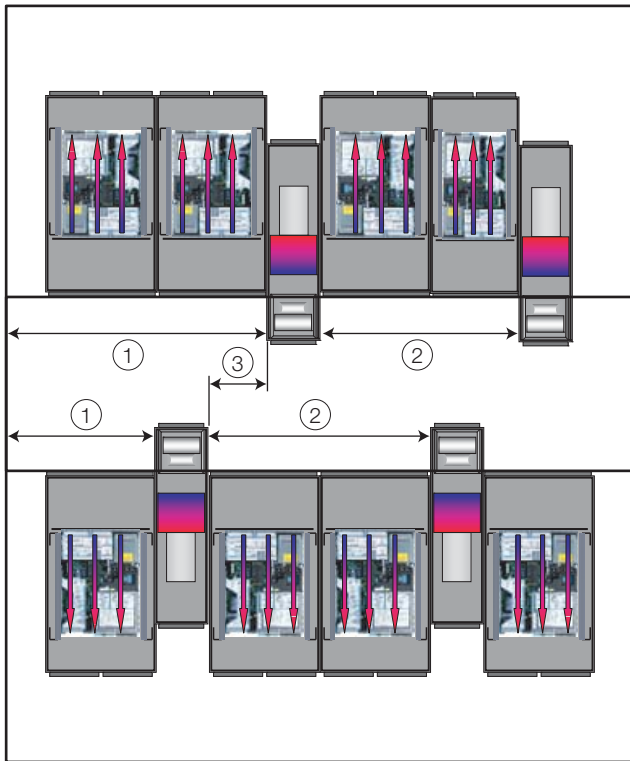

Fig. 21: Minimum and maximum distances

Key

- 1 Distance LCP – external wall
- 2 Distance LCP – LCP
- 3 Side offset from opposite LCP

Pressure within cold aisle containment

When using an LCP Inline or LCP Inline flush, there is an overpressure in the cold aisle compared with the exterior room (hot aisle). Depending on the IT equipment used, however, the pressure in the cold aisle may also fluctuate.

5.2 Assembly procedure

5.2.1 General

Before the Liquid Cooling Package can be bayed onto the server enclosure, the following work should be carried out.

- Dismantle the side panels,
- Seal the server enclosure and
- Dismantle the server enclosure door (with the glazed door closed).

5.2.2 Dismantle the side panels



Caution! Risk of injury!
The side panel holders have sharp-edged teeth, which enable earthing of the server enclosure's side panel.

If there is a side panel or partition mounted on the server enclosure side to which the Liquid Cooling Package is to be bayed, this must be removed first.

- Loosen and remove the 8 assembly screws found on each side panel of the server enclosure.
- Remove all side panel securing elements from the side of the server enclosure onto which the Liquid Cooling Package is to be bayed.
- Dismantle both side panel mountings from the upper mounting rail of the server enclosure, using an appropriate lever.
- Loosen and remove the screws on both of the side panel mounting brackets (top and bottom) in the middle of the mounting rail.
- Loosen and remove the screws from the 6 side panel holders on the side mounting rails.

5.2.3 Seal the server enclosure

In order to ensure targeted air routing in the system, the server enclosure is vertically divided into hot air and cold air zones by sealing the 482.6 mm (19") level.

Proceed as follows to seal the 482.6 mm (19") level:

- If the server enclosure is only partially configured, seal the open sections of the 482.6 mm (19") level using blanking plates. Screw these tightly into the server rack from the front.



Note:

Blanking plates in the various height units (U), together with both narrow and wide foam strips and air baffle plates, are available as Rittal accessories (see section 16 "Accessories").

- Fasten the wider (Model No. 3301.370 / 3301.320) of the two foam strips from the Liquid Cooling Package accessories from outside onto one of the front supports of the server rack (fig. 22). Make sure to install this strip on the side of the server enclosure onto which the Liquid Cooling Package is to be bayed.
- **If you are only baying the Liquid Cooling Package on one side:** Fasten the narrower (Model No. 3301.380 / 3301.390) of the two foam strips from the Liquid Cooling Package accessories from outside onto one of the front supports of the server rack (fig. 22). Make sure to install this strip on the side of the server enclosure which will again be sealed by a side panel.

5 Assembly and siting

EN

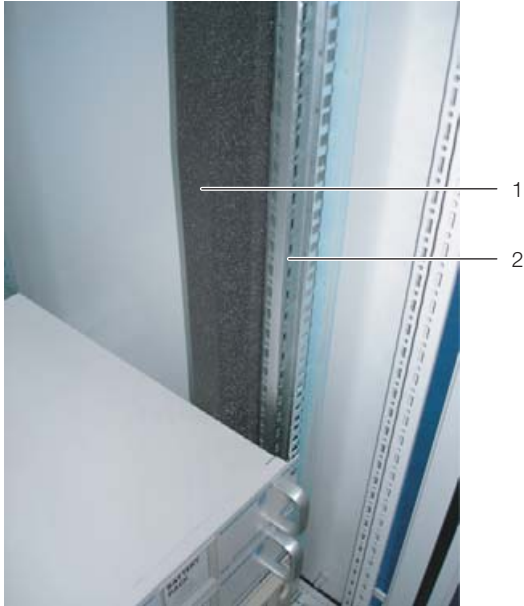

Fig. 22: Foam strip on a server rack support

Key

- 1 Foam strip
- 2 Server rack

If the server enclosure contains devices which require cooling via sideways air throughput (e.g. switches, router, etc.), cut-outs must be incorporated into the foam strips.

- To do this, cut out a piece of the foam strip with a sharp knife.
- If several devices which require sideways air throughput are included, cut out several pieces of the foam strip, as is appropriate, so that, ultimately, there is a cut-out in the foam to the left or right at the height of each such device in the server rack. Ensure that there are no gaps on the hot air side of the device (fig. 23, item 3).
- Using a sharp knife, cut additional pieces from the foam strips that are at least as long as the height of the built-in devices.
- Attach the foam strips to the cold air side of the devices set back towards the rear (fig. 23, item 4), making sure that all fans built into the devices can draw air and that none of them are blocked.



Note:

The foam strips can be attached between the front and rear supports of the server rack along the entire depth of the devices with sideways air throughput (fig. 23, item 5).

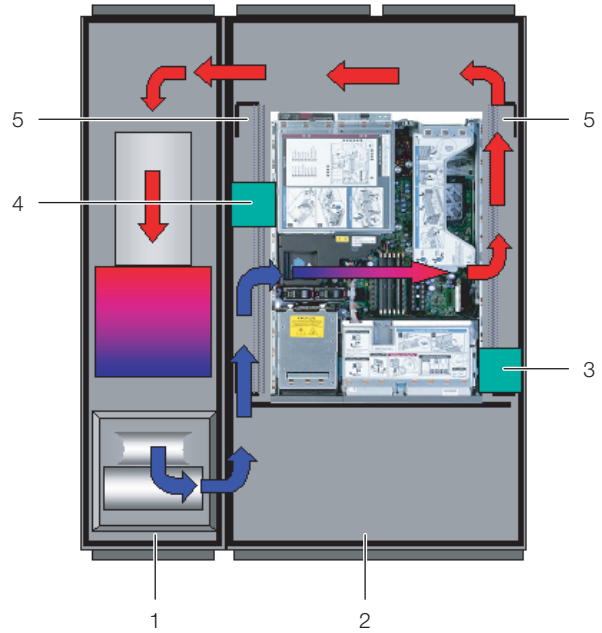

Fig. 23: Placement of foam strips for devices with sideways air throughput (top view) – LCP Rack

Key

- 1 LCP Rack
- 2 Server enclosure
- 3 Foam strips on hot air side
- 4 Foam strips on cold air side
- 5 Area in which the foam strips can be positioned

- If there is any surplus length of the foam strip on the server rack, cut it off at the top edge of the rack.



Note:

The Liquid Cooling Package may optionally be bayed onto a server enclosure with a width of either 600 mm or 800 mm. For this reason, the Liquid Cooling Package accessories include a total of four foam strips or corresponding air baffle plates with differing dimensions (see section 16 "Accessories").

- On the side of the server enclosure opposite the Liquid Cooling Package, mount a side panel on the two side panel mountings. Align it with the front and rear of the enclosure.
- Using the 8 assembly screws, screw the side panel firmly onto the side panel holders and the side panel mounting brackets.
- Seal off any cable entries which may be present with corresponding brush strips or similar.

5.2.4 Dismantle the server enclosure door

Before buying a Liquid Cooling Package, at least one of the two server enclosure doors must be dismantled so that the attachment points for the baying connectors are accessible and are not covered by a door edge.



Note:

It is only necessary to dismantle a server enclosure door when the Liquid Cooling Package is to be bayed onto a previously erected server enclosure.

Otherwise, this work is not necessary.

If the Liquid Cooling Package is to be installed together with a new server enclosure, proceed according to the enclosure's assembly instructions and bay the Liquid Cooling Package onto the server enclosure before assembling the server enclosure doors.

Proceed as follows to dismantle a server enclosure door:

- Remove the sealing bungs from the four door hinges with an appropriate tool (e.g. screwdriver).
- Release and open the server enclosure door.
- Loosen the hinge bolts from the four door hinges by raising them with an appropriate tool (e.g. screwdriver). Pull the bolts out of the hinge pin holding fixture as far as they will go (see fig. 24, step A). Begin with the lowest door hinge.

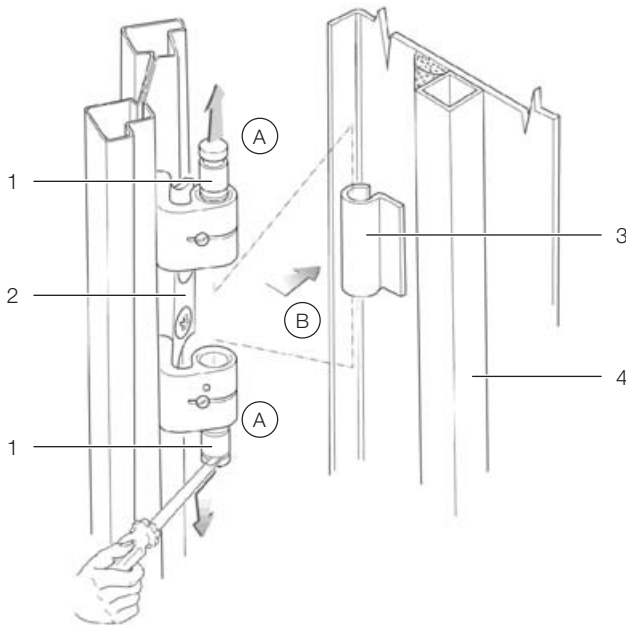

Fig. 24: Removing a door hinge

Key

- 1 Door hinge
- 2 Hinge pin holding fixture
- 3 Hinge joint
- 4 Server enclosure door



Note:

Support the server enclosure door so that it will not fall as the door hinges are loosened. If necessary, work with a second person.

- Remove the server enclosure door (fig. 24, step B).

5.2.5 Fit the rear adaptor on the LCP Inline

In order to achieve an even finish for the LCP Inline and the server enclosure fronts at the rear, a corresponding enclosure extension may be installed on the LCP Inline (see section 16 "Accessories").

- Dismantle the rear door of the LCP Inline in the same way as the server enclosure (see section 5.2.4 "Dismantle the server enclosure door").
- Dismantle the hinge pin holding fixtures (fig. 25, item 1) and corresponding fixing components (fig. 25, item 2) from the LCP Inline and reassemble at the rear of the adaptor in the same way.



Fig. 25: Assembly components on the Liquid Cooling Package – rear view

Key

- 1 Hinge pin holding fixture
- 2 Fixing component

- Attach the adaptor (fig. 26, item 2) to the rear opening of the LCP Inline using four of the supplied screws (fig. 26, item 1) each on the left and right.

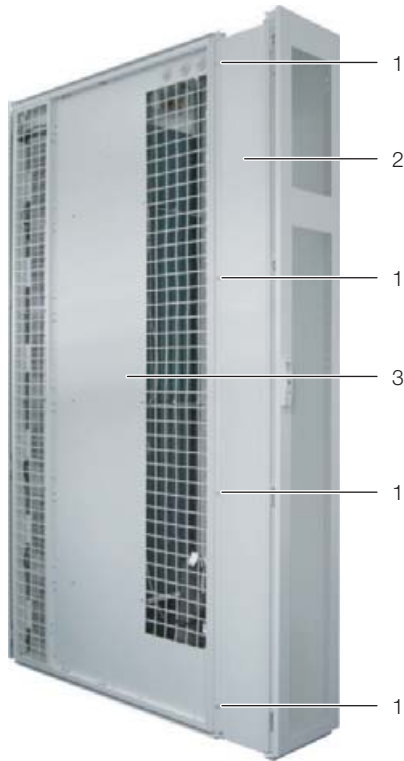

Fig. 26: Adaptor on the LCP Inline

Key

- 1 Assembly screws
- 2 Adaptor
- 3 LCP Inline

- Fit the door at the rear of the adaptor if you are securing the LCP Inline to the server enclosure with the aid of baying clamps.

Note:
If you are securing the LCP Inline to the server enclosure with the aid of baying clamps, do not fit the rear door yet.

5.2.6 Fit the trim panels if siting without a rear adaptor

If no rear adaptor is installed at the rear of the LCP Inline, with bayed server racks, a gap will appear when the side panels are removed.

- Fit a compensating panel (see section 16 "Accessories") to the server racks in the rear section in order e.g. to prevent unauthorised access to the server racks.

5.2.7 Installation and baying of the Liquid Cooling Package

- Position the Liquid Cooling Package on the side of the server enclosure to which it is to be bayed.
- Pull the LCP Inline forwards until the air outlet holes on the side of the LCP Inline are completely in front of the front edge of the server enclosure.
- Align the Liquid Cooling Package with the server enclosure. Ensure that the Liquid Cooling Package is

aligned levelly and that both enclosures are adjusted to the same height and are vertically aligned to each other.

- Dismantle the door of the Liquid Cooling Package whose hinges are on the side on which the server enclosure is to be bayed. Proceed as described in section 5.2.4 "Dismantle the server enclosure door".

Note:
If the Liquid Cooling Package is to be bayed between two server enclosures, both doors of the Liquid Cooling Package must be dismantled before the baying connectors are installed so that the attachment points for the baying connectors are accessible.

Attaching the LCP Rack and LCP Inline

- Using the corresponding assembly screws, fasten three baying connectors each (fig. 27, item 2) onto the attachment points provided in the mounting strips on the front and rear of the LCP Rack or LCP Inline flush (fig. 27, item 1).

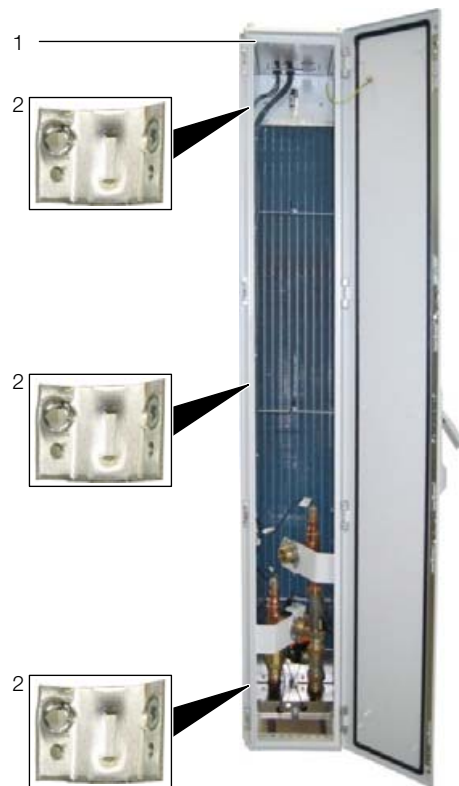

Fig. 27: LCP Rack – rear

Key

- 1 LCP Rack
- 2 Baying connector

- In the same way, fasten the baying connectors onto the attachment points provided in the mounting strips on the front and rear of the server enclosure. If necessary, press the LCP Rack or LCP Inline flush lightly against the server enclosure in order to bring the bay-

ing connectors into alignment with the attachment points.

Attaching the LCP Inline

- Before baying the LCP Inline, dismantle any partitions or side panels that may be present on the server enclosure.
- In the front section, push out a baying clamp (fig. 28, item 3) from the server enclosure (fig. 28, item 2) through the corresponding notch in the side panel of the LCP Inline (fig. 28, item 1).
- From the server enclosure, tighten the baying clamp (fig. 28, item 4), so that the frames of the server enclosure and LCP Inline are firmly connected to one another.

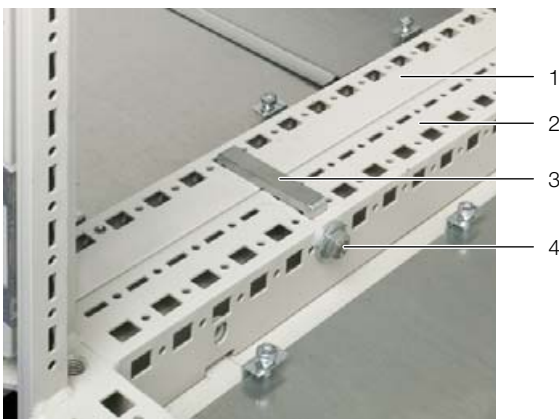

Fig. 28: Baying clamp

Key

- 1 LCP Inline
- 2 Server enclosure
- 3 Baying clamp
- 4 Assembly screw of baying clamp

- In the same way, insert a second baying clamp to connect the server enclosure and LCP Inline in the rear section.



Note:

If the rear frame is fitted on the LCP Inline, it may alternatively be fitted at the rear between the frame and the server enclosure, analogous to the LCP Rack, using three baying clamps (see the section on "Attaching the LCP Rack").

All device versions:

- Where applicable, attach the rear door to the LCP Rack or to the rear adaptor of the LCP Inline.
- Finally, check the stability of the Liquid Cooling Package once again.

5.2.8 Mounting the side panel

If the Liquid Cooling Package is not bayed between two server enclosures, close it off with a side panel.



Caution! Risk of injury!

The side panel holders have sharp-edged teeth, to enable earthing of the side panel through the Liquid Cooling Package.

Proceed as follows to assemble the side panel:

- Remove the various assembly components from the optional side panel package (Model. No. 8100.235) or use those from a server enclosure which has already been dismantled.
- Using the assembly screws, mount the assembly components (2 side panel mountings, 2 side panel mounting brackets, 6 side panel holders) onto the side of the Liquid Cooling Package which is opposite to the server enclosure.
- Place both side panel mountings as symmetrically as possible onto the upper mounting rail of the Liquid Cooling Package and, using your hand, press them firmly in place.
- Screw down the two side panel mounting brackets top and bottom in the centre of the mounting rail using one screw each.
- Screw down 3 side panel holders onto each of the two side mounting rails with one screw each.
- Mount a side panel onto the two side panel mountings of the Liquid Cooling Package and align them to the front and rear of the unit.
- Using the 8 assembly screws, screw the side panel firmly onto the side panel holders and the side panel mounting brackets.

5.3 Fan installation

As delivered, the Liquid Cooling Package contains the following number of fan modules as standard:

LCP Rack and LCP Inline:

- 30 kW version (3311.130/230/530):
One fan module at position 3
- 55 kW version (3311.260/560):
Four fan modules at positions 2, 3, 4 and 5

LCP Inline flush:

- 30 kW version (3311.540):
Two fan modules at positions 1 and 3



Note:

The maximum of four fans in the LCP Inline flush are located in positions 1, 2, 3 and 4. Please take particular note of this when connecting the fans (see section 5.3 "Fan installation").

Depending on the required cooling output and in order to form redundancies, up to a maximum of six fan mod-

5 Assembly and siting

EN

ules in total may be installed with the LCP Rack and LCP Inline devices. With the LCP Inline flush, up to four fan modules may be installed (see section 17.2 "Tables and characteristic curves").



Note:

If more than three fans are installed in a Liquid Cooling Package type "30 kW", these are used to create redundancy or for lower power consumption by the individual fans. However, they will not lead to a further increase in the cooling output.

5.3.1 Removing a fan module

If a fan module is defective, it can be replaced quickly and easily with the unit operational.

Proceed as follows to remove a fan module:

- Open the front door of the Liquid Cooling Package.
- Disconnect the thermally activated switch for the pair of fans from which one of the fans is to be removed at the fuse box.



Fig. 29: Fuse box with master switch

Key

- 1 Thermally activated switch 1
- 2 Thermally activated switch 2
- 3 Thermally activated switch 3
- 4 Thermally activated master switch

The following assignment applies between the thermally activated switches and the fans:

- Thermally activated switch 1:
Fan positions 1 and 2
- Thermally activated switch 2:
Fan positions 3 and 4
- Thermally activated switch 3:
Fan positions 5 and 6



Note:

On the LCP Inline flush, thermally activated switch 3 (fig. 29, item 3) is not assigned and therefore has no function.

Configuration with LCP Rack and LCP Inline:

- Should you wish to exchange fan 2 and if the optional display with touch function is installed, please first disconnect connector X33 of the connection cable (fig. 30, item 2).
- Release the two fan connectors DC and AC on the left and right (fig. 30, items 3 and 5).
- Disconnect the earth connection on the fan (fig. 30, item 4).
- Loosen the two knurled/hex screws, right and left (fig. 30, item 1), at the top and bottom of the fan mounting plates.

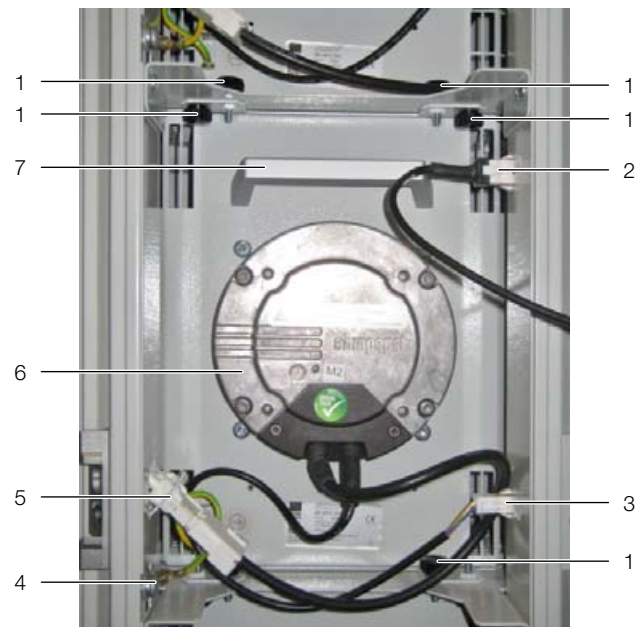

Fig. 30: Fan module in fan tray – LCP Inline and LCP Rack version

Key

- 1 Knurled screws/Hex screws
- 2 Connection cable for display with touch function
- 3 Connector DC
- 4 Earth connection
- 5 Connector AC
- 6 Fan
- 7 Handle

- Rotate the fan module in the rack by 90° in a counter-clockwise direction (fig. 31).



Fig. 31: Rotated fan module in fan tray – LCP Inline and LCP Rack version

- Grasp the fan module with both hands on the left and right, and pull it out of the rack.

Configuration with LCP Inline flush:

- Should you wish to exchange fan 1 and if the optional display with touch function is installed, please first disconnect connector X33 of the connection cable.
- Release the two fan connectors DC and AC on the left and right (fig. 32, items 2 and 6).
- Disconnect the earth connection on the fan (fig. 32, item 3).
- Loosen the two knurled/hex screws (fig. 32, item 7) on the fan's air baffle plates at the top and bottom respectively.



Fig. 32: Fan module in fan tray – LCP Inline flush version

Key

- 1 Air baffle plate
- 2 Connector DC
- 3 Earth connection
- 4 Fan
- 5 Handle
- 6 Connector AC
- 7 Knurled screws/Hex screws

- Rotate the fan module in the rack by 90° in a clockwise direction (fig. 33).



Fig. 33: Rotated fan module in fan tray – LCP Inline flush version

5 Assembly and siting

EN

- Grasp the fan module with both hands on the left and right, and pull it out between the upper and lower air baffle plate.

5.3.2 Installing a fan module



Note:
The installation site of individual fan modules may be varied according to the load.

As supplied, all rack mounts not fitted with a fan are sealed with a metal cover. For units not fully populated with fans, these metal covers ensure separation into a hot and cold air zone inside the device, for targeted air routing.



Caution! Risk of injury!
Before installing or removing a fan, be sure to remove the power from the relevant group of fans on the corresponding thermally activated switch.

Configuration with LCP Rack and LCP Inline:

- Disconnect the earth connection on the metal cover (fig. 34, item 3).
- Loosen the two knurled/hex screws, right and left (fig. 34, item 1), used to secure the metal cover in the rack mount at the top and bottom.
- Remove the metal cover (fig. 34, item 2) from the rack mount.



Fig. 34: Metal cover – LCP Rack and LCP Inline version

Key

- 1 Knurled screws/Hex screws
- 2 Metal cover
- 3 Earthing cable connection

- Place the fan module on the shelf rotated through 90° (fig. 31) and push it into the rack mount.
- Rotate the fan module through 90° in a counter-clockwise direction so that the connection cables are pointing towards you.

- Secure the fan module to the mounting plate at the top and bottom using two knurled/hex screws, left and right.
- On the left and right, insert one of the fan connectors into the corresponding socket on the Liquid Cooling Package.
- Make the earth connection to the fan.
- At the fuse box, re-connect the thermally activated switch for the pair of fans of which one fan has been replaced.
- Activate the newly installed fan in the software (see section 8.2.4 "LCP configuration").

Configuration with LCP Inline flush:

- Disconnect the earth connection on the metal cover (fig. 35, item 3).
- Loosen the two knurled/hex screws at the top and bottom (fig. 35, item 1) used to secure the metal cover in the rack mount.
- Remove the metal cover (fig. 35, item 2) from the rack mount.



Fig. 35: Metal cover – LCP Inline flush version

Key

- 1 Knurled screws/Hex screws (4 x)
- 2 Metal cover
- 3 Earthing cable connection

- Place the fan module rotated through 90° (fig. 33) between the upper and lower air baffle plate and push the module into the rack mount.
- Rotate the fan module through 90° in a counter-clockwise direction so that the connection cables are pointing towards you.
- Secure the fan module to the mounting plate at the top and bottom using two knurled/hex screws, left and right.

- On the left and right, insert one of the fan connectors into the corresponding socket on the Liquid Cooling Package.
- Make the earth connection to the fan.
- At the fuse box, re-connect the thermally activated switch for the (pair of) fans of which one fan has been replaced.
- Activate the newly installed fan in the software (see section 8.2.4 "LCP configuration").

5.4 Install the optional display (3311.030)

In its delivered state, there is already a suitable opening provided in the front door of the Liquid Cooling Package for installing the optional display. This opening is sealed from the inside by a trim panel.

- Open the front door of the Liquid Cooling Package.
- Loosen the attachments of the trim panel.
- Remove the trim panel to the outside of the door.
- Insert the fastening clamps with screws (fig. 36, item 2) on the left and right of the display.

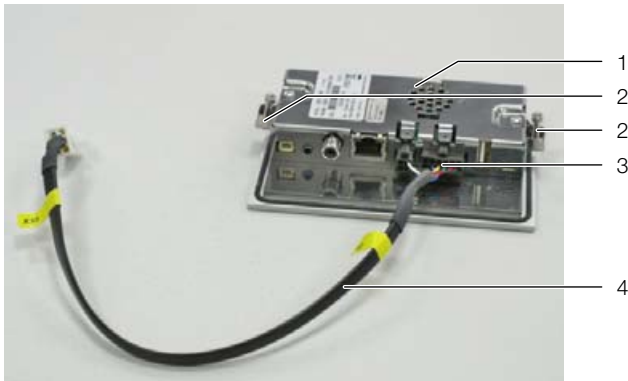

Fig. 36: Preparing the graphic display

Key

- 1 Display with touch function
- 2 Fastening clamps
- 3 Connectors for display (4- and 12-pole)
- 4 Connection cable

- Insert the connection cable (fig. 36, item 4) into the bottom of the display (fig. 36, item 3).
- Push the display into the cut-out from the outside until it is in contact with the door (fig. 37, item 1) of the Liquid Cooling Package at the front.
- Tighten the two assembly screws (fig. 37, item 2) from the inside.

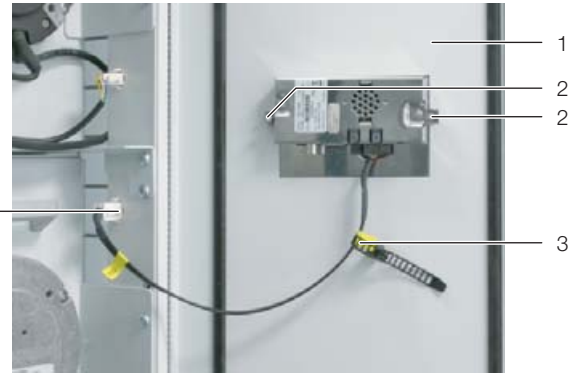

Fig. 37: Securing the graphic display

Key

- 1 Inner view of door, LCP Inline
- 2 Assembly screws
- 3 Strain relief, connection cable
- 4 Connection socket in LCP Inline

- Connect the connection cable of the display to the corresponding socket in the Liquid Cooling Package (fig. 37, item 4).
- Attach the strain relief (fig. 37, item 3) to the connection cable to prevent accidental damage to the cable e.g. when opening the door.

After connection, the following display will appear:

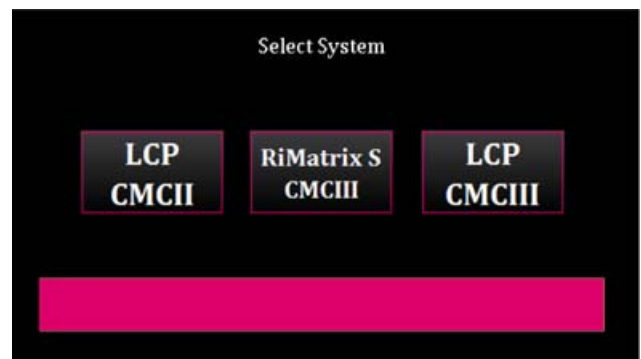

Fig. 38: Display after connecting

Please select which version of the control unit is installed in your Liquid Cooling Package (LCP CMCII or LCP CMCIII). Under no circumstances should you select "RiMatrix S CMCIII".



Note:

If the control unit entry is incorrect, no values are displayed and operation via the display will not be possible. The display will first need to be reset by the Rittal service department.

- Open the front door of the Liquid Cooling Package.
- Select the point "CMCII" if a device with a grey front panel marked "CMC-TC" is installed.
- Select the point "CMCIII" if a device with a grey front panel marked "CMC III PU" is installed, as shown in fig. 29.

6 Installation

6.1 Connecting the Liquid Cooling Package

6.1.1 Electrical connection

General



Note:

Please keep this electrical documentation readily available so that it is always on hand when needed. This is the only documentation which is authoritative for the unit.



Caution!

Work on electrical systems or equipment may only be carried out by an electrician or by trained personnel guided and supervised by an electrician. All work must be carried out in accordance with electrical engineering regulations.

The unit may only be connected after the above-named personnel have read this information.

Use only insulated tools.

The connection regulations of the appropriate electrical power company are to be followed.

The voltage values shown in the wiring plan or on the rating plate must match the mains voltage.

The pre-fuse specified in the wiring plan/rating plate should be provided to protect the cable and equipment from short-circuits. The unit must be individually fused.

The unit has a high discharge current. Before connecting to the power line and switching on the device it is essential, therefore, to make a 10 mm² earth connection (see section 17.4 "Circuit diagram").



Caution!

The unit must be connected to the mains via an isolating device which ensures at least 3 mm contact opening when switched off.

No additional control equipment may be connected upstream of the device at the supply end.

Power to the Liquid Cooling Package is supplied via a separate 3-wire or 5-wire infeed, as desired. The device is always delivered with a 5-pole mains connection socket so that the user can attach a connection cable with a mains plug (3-wire or 5-wire) depending on the operator's requirements.



Fig. 39: Connections in the rear top area

Key

- 1 Terminal strip X6 for alarm relay (floating contact, max. 24 V DC, 1 A)
- 2 Terminal strip X1, 5-pole, for mains connection
- 3 Terminal strip X2 for optional condensate pump AC
- 4 Jack X5 for connecting a CAN bus sensor
- 5 Jack X4 for network connection
- 6 Terminal strip X3 for optional condensate pump DC

Two of the fan modules installed in the Liquid Cooling Package are on separate phases.

If the Liquid Cooling Package is connected to the mains using a 3-wire, single-phase, 230 V connection cable (L, N, PE), one of the phases of this cable must be bridged to the other two.

If the Liquid Cooling Package is connected to the mains using a 5-wire connection cable (400 V, 3~, N, PE; 7856.025), three separate phases (L1, L2, and L3) are available.

If one of the phases fails, the device will continue to be supplied with power and will remain operational as follows:

Failure in phase L1:

The fans at positions 1 and 2 switch off, while the fans at positions 3 to 6 remain operational.

Failure in phase L2:

The fans at positions 3 and 4 switch off, while the fans at positions 1 and 2 and 5 and 6 remain operational. Furthermore, the optionally installed condensate pump no longer has a supply voltage.

Failure in phase L3:

The control unit (CMC III PU) is no longer supplied with power. The fans at positions 5 and 6 switch off. The fans at positions 1 to 4 go into so-called "fail-safe" mode with 100% fan speed, due to the absence of a setpoint from the control unit.

**Note:**

The voltage tolerance must not exceed a maximum of $\pm 10\%$ of the mains voltage specified on the rating plate.

- In the supply line to the Liquid Cooling Package, please provide the fuse specified on the rating plate (for single-phase operation e.g. a 20 A pre-fuse), in order to maintain the necessary protection against short-circuits even if fully populated with four or six fans.

**Note:**

Both the fans in a group have a rated current of around 4.2 A and are protected in the device with a 6 A thermally activated switch. With 6 fans, therefore, this translates into 3 groups. The master switch, likewise with thermal fuse, is tailored to these groups.

**Note:**

Information on the cross-section of the connection cable may be found in section 17.4 "Circuit diagram".

**Danger!**

Take utmost care not to short-circuit one of the phases with the zero conductor or the earth conductor. Otherwise, there is a risk of damage or injury.

Electrical connection with the supplied 5-pole connector**5-wire, 3-phase connection**

To connect the Liquid Cooling Package to the mains using a 5-wire, 3-phase connection cable, proceed as follows:

- Remove approximately 45 mm from the rubber sheathing of the flexible cable.
- Trim the neutral conductor (N) and the three phase conductors (L1, L2, and L3) to a length of approximately 35 mm. Leave the length of the PE conductor at approximately 45 mm.
- Remove approximately 9 mm from the insulation of all conductors with a suitable tool.

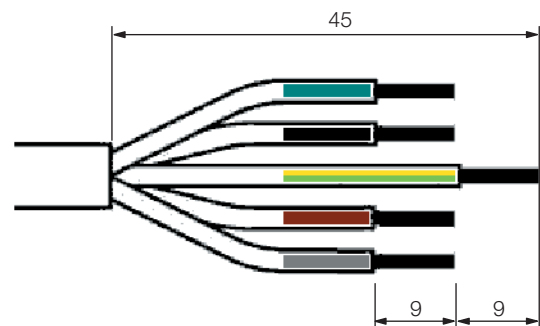

Fig. 40: Dimensions for removing the rubber sheathing and insulation

- Attach wire end ferrules without insulating collar to the ends of the cables, using a four-jaw pressing tool.
- Connect all conductors to the connector (X-Com plug).
- Insert a suitable screwdriver (blade size 3.5 x 0.5 mm) into an activation opening (fig. 41, item 1) and open the corresponding terminal connection of the conductor entry (fig. 41, item 2).
- Insert the conductor completely into the conductor entry and then remove the screwdriver to close the terminal connection.

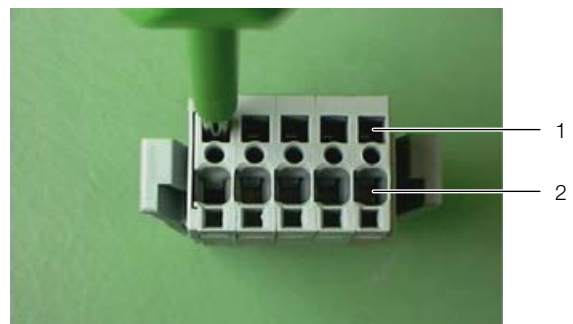

Fig. 41: Connector – rear

Key

- 1 Activation opening of the terminal connector for the conductor entry
- 2 Conductor entry

6 Installation

EN



Note:

The configuration of the connector may be found in section 17.4 "Circuit diagram".

- Press the bottom piece of the strain relief housing from below onto the connector.
- Guide the conductors in the strain relief housing, as shown in fig. 42, and secure the sheathed flexible cable to the strain relief housing with a cable clamp.

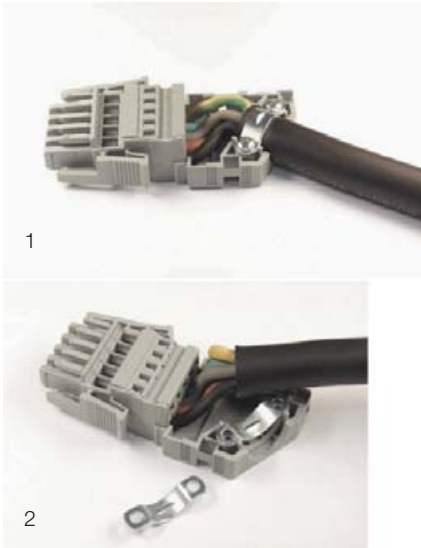

Fig. 42: Connector with strain relief housing

Key

- 1 Strain relief for conductors with $\varnothing > 12$ mm
- 2 Strain relief for conductors with $\varnothing < 12$ mm



Note:

To ensure adequate strain relief even with cables with a diameter of < 12 mm, it is necessary to install a second cable clamp underneath the cable (fig. 42, item 2).

- Close the strain relief housing by pressing the top piece of the housing onto the bottom piece from above (fig. 43).



Fig. 43: Closing the strain relief housing

3-wire, single-phase connection



Caution!

With a 3-wire, single-phase connection, the conductor cross-section must be at least 2.5 mm².

To connect the Liquid Cooling Package to the mains using a 3-wire, single-phase connection cable, proceed as follows:

- Remove approximately 45 mm from the rubber sheathing of the flexible cable.
- Trim the neutral conductor (N) and the phase conductor (L) to a length of approximately 35 mm. Leave the length of the PE conductor at approximately 45 mm.
- Remove approximately 9 mm from the insulation of all conductors with a suitable tool.

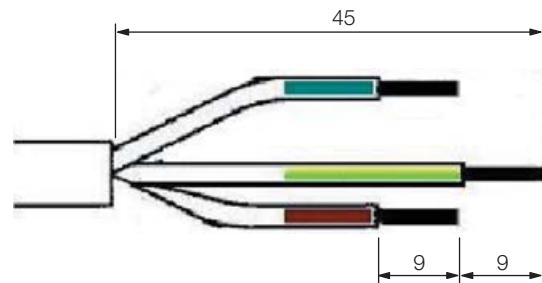

Fig. 44: Dimensions for removing the rubber sheathing and insulation



Note:

The example shows colour coding to DIN VDE 0293:
 blue = neutral conductor N
 brown = phase conductor L
 yellow/green = PE conductor

- Attach wire end ferrules without insulating collars to the ends of the conductors. To crimp the wire end ferrules, use a suitable crimping tool with an integral lock to prevent the tool from opening prematurely.
- Bypass the phase connections on the connector using the two bridges supplied (fig. 45, item 1). Place one bridge between phase conductors L1 and L2 and one bridge between phase conductors L2 and L3.

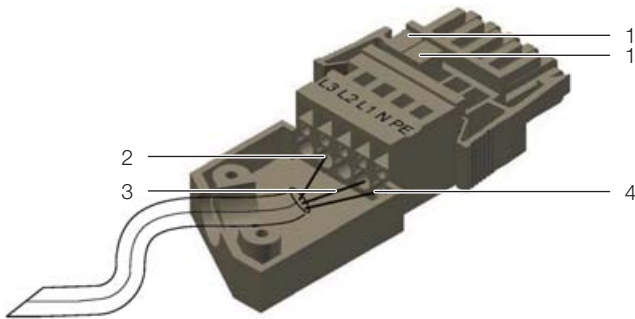

Fig. 45: Schematic diagram of the connector with strain relief housing

Key

- 1 Bridges for bridging the phase conductors
- 2 Phase conductor (L)
- 3 Neutral conductor (N)
- 4 PE conductor

■ To connect the connector, proceed as described in the section "5-wire, 3-phase connection".

6.1.2 Cooling water connection

The Liquid Cooling Package is connected to the cold water network via two 1½" threaded pipe connections (external thread) on the inlet and return, located on the lower rear of the unit. The connection nozzles are positioned horizontally to the rear.



Fig. 46: Cold water network connection:

Key

- 1 Cooling water return with 1½" external thread
- 2 Cooling water inlet with 1½" external thread

Connection is made in a downward direction into a raised floor (if available), or alternatively in an upward direction out of the device. The dimensions of the mounting openings required for connection are shown in the overview sketch in section 17.3 "Overview drawings" (see fig. 87).



Note:

If possible, use flexible hoses for the cooling water connection (see section 16 "Accessories").



Note:

The cooling water connection must **always** be made with union nuts, even if you choose not to use the Rittal hose connection kit. This hose connection kit includes suitable union nuts in addition to the connection hoses.



Fig. 47: Hose connection kit

Key

- 1 Union nut
- 2 90° bracket
- 3 Connection hose



Caution!

When installing, observe the applicable specifications concerning water quality and water pressure.

In case of a low water inlet temperature (<12°C), the inlet and return lines should be appropriately insulated. If this is not done, condensate may form on the supply lines.

6 Installation

EN



Note:

Immediately after connecting the water circuit, the flow rate may be monitored by fitting the device with an optional display with touch function. To do this, first check whether the control valve is completely open (see section 9.2.3 "Operation in stand-alone mode"). If the control valve is closed or only partially open, it can be opened in manual mode via the web interface (see section 9.5.4 "Config").



Note:

The pipework in the building should be designed according to the Tichelmann Principle in order to maintain a hydraulically balanced system.

If this is not the case, the flow volume of each Liquid Cooling Package must be assured by using a flow quantity regulator.

Ideally, the Liquid Cooling Packages are connected to the cooling water circuit via a water/water heat exchanger when using a water/glycol mixture.

Pros:

- Reduction of water volumes in the secondary circuit,
- Setting of a defined water quality,
- Setting of a defined input temperature and
- Setting of a defined volumetric flow.

General remarks on the cold water system

IT climate control poses a major challenge for the cold water system, because the IT equipment whose heat loss is to be dissipated by the cold water system can undergo multiple load changes per minute. This hysteresis is transferred directly to the cold water system, leading to a fluctuating ΔT . If this causes a major load step, leading to a rapid increase in heat loss, cold water must be made available immediately by the cold water system. Depending on the distance of the cooling unit from the IT cold water circuit, this can create a significant dead time during which no water is available to cool the IT heat loss.

Because of hysteresis induced by the IT equipment, ΔT fluctuations in the cold water circuit are unavoidable. Fluctuations of between 1 K and 10 K are not uncommon in IT climate control. For this reason, the usual ΔT of 6 K for a cold water circuit cannot be used to calculate the pipework. In the case of Liquid Cooling Packages, the volumetric flow required for the rated cooling output is always specified. With this volumetric flow, the correct pipe dimensions can be selected when calculating the pipework. Because very high cooling out-

puts of up to 55 kW are required for each Liquid Cooling Package, in addition to individual sections of pipe it is also advisable to hydraulically regulate the individual connection lines.

Example of an injection circuit

Fluctuations in the ΔT in the cold water circuit can be compensated using an hydraulic circuit. For example, by assembling an injection circuit, the cold water system is able to counteract the hysteresis generated by the IT equipment.

With the injection circuit, the primary circuit is installed as close as possible to the secondary circuit. The secondary circuit is assembled in the immediate vicinity of the equipment. The cold water is able to circulate permanently in the primary circuit, and is therefore always available when needed by the secondary circuit. Without this circuit, the cold water would first need to cover the entire distance from the producer to the equipment whenever the flow rate is altered by the equipment. Here too, there may be a significantly lower temperature in the primary circuit than in the secondary circuit, e.g. 6°C in the primary circuit and 15°C in the secondary circuit as a result of mixing.

In this way, the primary circuit pump 1 permanently provides the secondary circuit with water. The mixer valve in the return limits the volume of water flowing out of the secondary circuit and back into the primary circuit. This therefore limits the incoming water volume as well. The secondary circuit pump allows the entire volume of water required for cooling in the secondary circuit to circulate, and is responsible for mixing the temperatures. Pump 2 allows water from the secondary return to be "injected" into the secondary inlet via the bypass. In this way, cold water from the primary circuit is raised directly to the correct temperature level. The injection circuit is just one example of many possibilities for adapting the cold water system to the requirements of IT climate control.

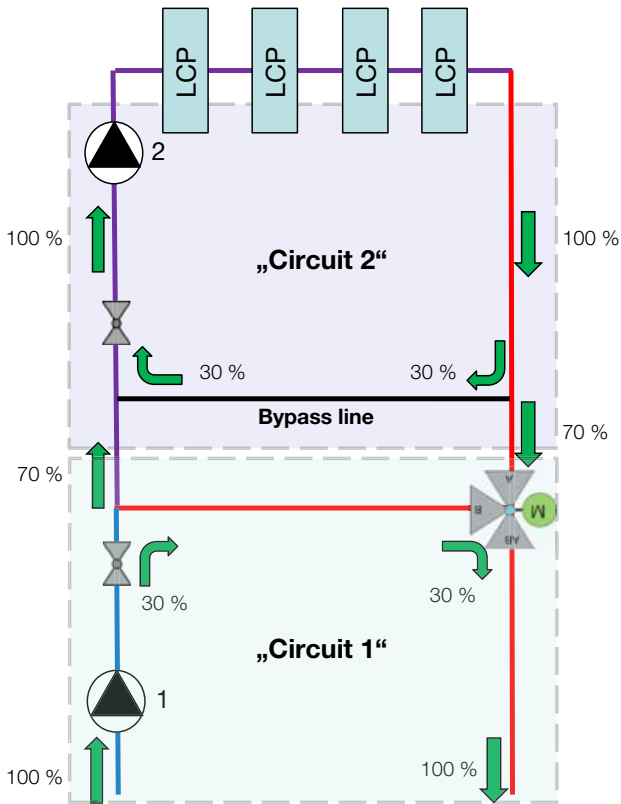

Fig. 48: Injection circuit (layout diagram)

In the LCP, there is a sensor built into the upstream end, which contactlessly measures the water flow rate. The measurement range of this flow meter is between 5 l/min and 100 l/min for the 30 kW units (3311.130/230/530/540) and between 10 l/min and 200 l/min for the 55 kW units.

If the server racks are initially only equipped with minimal IT equipment, or if operating at low water inlet temperatures (e.g. 6°C), the flow rate will be low. If this flow rate falls below the aforementioned limits, this may lead to system warnings from the flow meter. These warnings may be deactivated by configuring the parameters "System Warning min. Flow" and "System Warning min. Valve" (see section 8.2.4 "LCP configuration")

Alternatively, the occurrence of such error messages can also be avoided by using the injection circuit. To this end, the supplied cooling water from the primary and secondary circuit must be mixed differently to create a higher inlet temperature.

Tichelmann principle and hydraulic balancing

For an efficient cold water supply to the Liquid Cooling Package, the cold water system must be hydraulically balanced. If the hydraulics are not balanced, the LCP systems will not be supplied homogeneously with the required volume of cold water. This will adversely affect efficient operation.

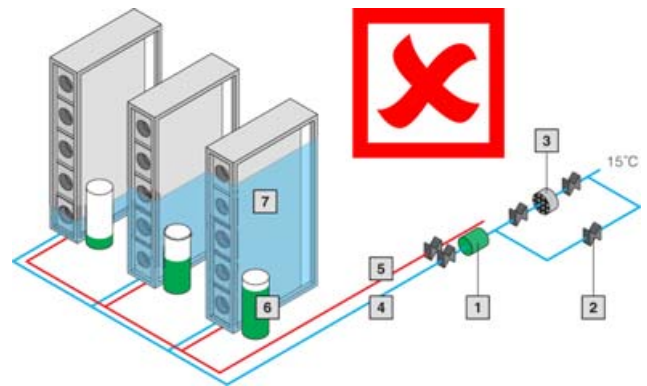

Fig. 49: Cooling distribution without hydraulic balancing

Key

- 1 Circulating pump
- 2 Shut-off valve
- 3 Fine filter
- 4 Return
- 5 Inlet
- 6 Pump pressure
- 7 Cooling supply
- 8 Pipe friction pressure loss
- 9 Opening degree of control valve
- 10 Control valve

Here, hydraulic balancing can be achieved via circuit control valves.

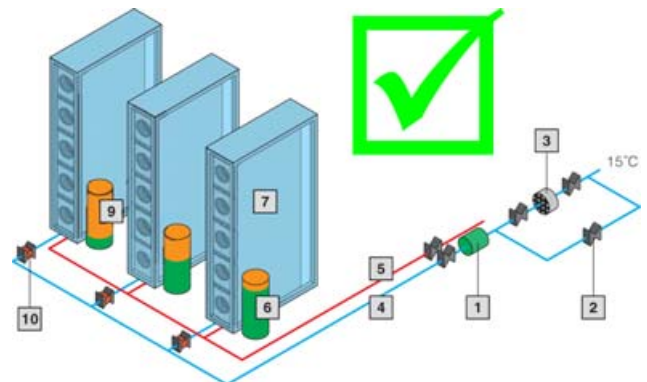

Fig. 50: Cooling distribution with hydraulic balancing

If, on the other hand, the individual connection lines for the LCP systems are laid according to the "Tichelmann" connection principle, hydraulic balancing is not necessary. With this connection variant, all individual connection lines have the same pressure loss.

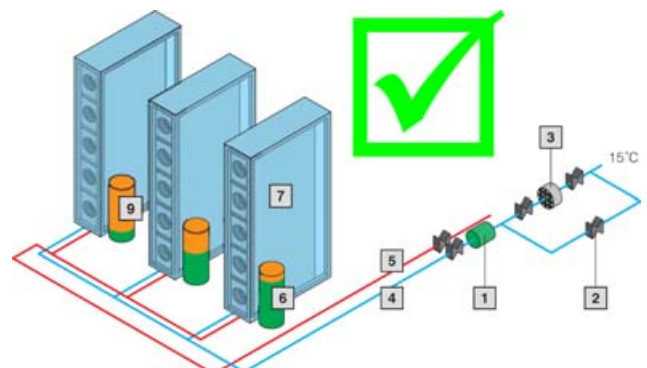

Fig. 51: Cooling distribution with Tichelmann principle

6 Installation

EN

Notes on water quality

For safe operation, it is vital that the VBG guidelines on cooling water are observed (VGB R 455P). Cooling water must not contain any limescale deposits or loose debris, and it should have a low level of hardness, particularly a low level of carbonate hardness. The carbonate hardness should not be too high, particularly for recooling within the plant. On the other hand, however, the water should not be so soft that it attacks the operating materials. When recooling the cooling water, the evaporation of large quantities of water must not lead to excessively high salt contents, since electrical conductivity increases as the concentration of dissolved substances rises, and the water thereby becomes more corrosive. For this reason, not only is it always necessary to add a corresponding quantity of fresh water, but also to remove part of the enriched water. Water with high gypsum content is unsuitable for cooling purposes because it has a tendency to form boiler scale that is particularly difficult to remove. Furthermore, cooling water should be free from iron and manganese, because deposits may occur which settle in the pipes and block them. At best, organic substances should only be present in small quantities, because otherwise sludge deposits and microbiological contamination may occur.



Note:

The Liquid Cooling Package is secured against excess pressure as regards a maximum permissible pressure (PS) of 6 bar if no cooling medium liquid is trapped. If shut-off valves that could cause cooling medium liquid to become trapped are installed on site, pressure relief vessels with safety valves (6 bar blow-off pressure) must be built into the coolant circuit of the recooling system.



Note:

Before commencing operation with water, all supply lines must be adequately flushed.



Note:

To avoid the loss of fluids due to diffusion (open and closed systems) or evaporation (open systems), the use of automatic filling is advisable.



Note:

The 2-way control valve used in the device is opened at zero current.

6.1.3 Connecting the condensate discharge

Any condensate which may develop is collected in the condensate collecting tray (fig. 52, item 1) in the water module of the Liquid Cooling Package.



Fig. 52: Condensate discharge

Key

- 1 Condensate collecting tray
- 2 Leakage sensor
- 3 Condensate discharge



Note:

The condensate drain must not be connected directly to the wastewater system, but to a wastewater connection with odour seal. When connecting, always observe the valid technical regulations.

The Liquid Cooling Package is additionally equipped with a condensate discharge (fig. 52, item 3) via which the condensate is pressurelessly routed out of the Liquid Cooling Package.

The hose included with the supply ($\varnothing_{int}=9.5$ mm, $\varnothing_{ext}=15.5$ mm) must be connected to the condensate discharge. This hose, in turn, must be routed to a drain with odour seal by the customer, so that any condensate can be discharged from the device.

If a leak occurs in the water circuit, upon reaching a defined level in the collecting tray, a message is triggered by the leak sensor (fig. 52, item 2). The status of the control valve may be set depending on this "leak message" (see section 8.2.4 "LCP configuration"). If the option **Emergency Mode** is selected, the valve will close completely, whereas if the option **Only Alarm Message** is selected, only an alarm message is output.



Note:

In order to ensure safe condensate discharge, the following points should be observed:

- Lay the drainage hose so that it always runs downhill and without any kinks.
- Do not constrict the hose cross section.

**Note:**

In order to avoid increased condensation and to reduce energy use, the cooling water temperature should be adapted to match the required cooling output.

6.1.4 Bleeding the air from the heat exchanger

A vent valve is installed at the uppermost point of the heat exchanger package in the Liquid Cooling Package. The unit is delivered with the valve fully closed. However, the valve must be opened during commissioning. Proceed as follows:

- Open the rear LCP door.
 - Connect the discharge hose included with the accessories to the top of the vent valve on the connector (fig. 53, item 2).
 - Route the other end of the hose into a container.
 - Open the ball valve (fig. 53, item 1).
 - Close the ball valve again when no further air bubbles are visible in the collecting container.
- The heat exchanger has now been vented.



Fig. 53: Bleeding the air from the heat exchanger

Key

- 1 Ball valve
- 2 Connector for discharge hose

- Then close the LCP door at the rear.

**Note:**

The system is usually bled during the course of commissioning. After bleeding, the ball valve should be closed again.

6.2 Cooling operation and control characteristics

When the Liquid Cooling Package is supplied with power, the control valve controls the cooling water flow according to the setpoint temperature. For more detailed explanations, please refer to section 3.1 "General functional description".

Detailed diagrams on cooling output and pressure loss may be found in section 17.2 "Tables and characteristic curves".

7 Commissioning checklist

EN

7 Commissioning checklist

Rittal GmbH & Co. KG hopes that this checklist will help its customers and cooperation partners install and operate the products of the Liquid Cooling Package family successfully.

Before the installation:

Are shut-off valves installed in the flow and return?

These valves serve to facilitate exchange or maintenance of the Liquid Cooling Package without the need to shut off the entire cold water supply.



Is there a Taco-setter installed in the return of each Liquid Cooling Package?

The tacho setter ensures a constant volumetric flow and helps to maintain the hydraulic balance of the system, especially when operating with other types of units, such as convectors.



Note:

If the pipework for the Liquid Cooling Package is carried out according to the Tichelmann principle, a Taco-setter is not necessary.

Is the water supply properly insulated?

Proper insulation protects against condensate formation, especially on the cooling water flow pipework.

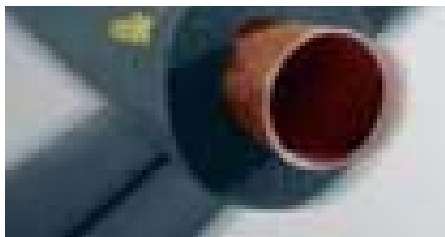

Photo Amacell

Are the allowable bend radii of the hoses adhered to?

The hoses must not be kinked too tightly, otherwise the flow volume may be impaired and the materials may fatigue prematurely. With connection hose 3311.040, please allow for a bending radius of 175 mm.



Is there a good water supply available which meets the quality requirements?

Water quality determines the lasting reliability of the system. It ensures that no undesirable corrosion or harmful deposits will occur. The exact manufacturer's recommendations regarding water quality are found in section 17.2 "Tables and characteristic curves". The recommended water quality should be ensured even after the installation.



Photo Honeywell

Was the pipework sufficiently flushed before the Liquid Cooling Package was connected?

It is important to clean or flush the water circuits appropriately, especially for new installations. Experience has shown that there are often remnants of sealants, lubricants, and even metal chips in new systems, which may lead to a premature failure of the Liquid Cooling Package. Cleaning the cold water system carefully before connecting the Liquid Cooling Package ensures reliable operation later.



If the water quality of the primary cold water supply is inadequate, was a separate water circuit with a water/water heat exchanger installed?

If the cold water supply is strongly contaminated, it may make sense to install a second, high quality cold

water circuit which is connected to the primary circuit via a water/water heat exchanger. Even in this case, the water circuit on the Liquid Cooling Package side must be carefully cleaned before connecting the device. Our recommendations regarding water quality in section 17.2 "Tables and characteristic curves" apply in this case as well.

Was the water prepared/treated with the appropriate additives?

In addition to our recommendations regarding water quality, we recommend that the water be enriched with corrosion inhibitor and/or antifreeze. Also, a treatment to prevent algae and biofilms may be expedient in some cases.



Photo Clariant

Are unused height units in the bayed server enclosures sealed with vertical blanking plates, and are the side vertical foam strips installed?

In order to prevent undesired air short circuits and circulation patterns inside the server enclosure, all unused height units of the 482.6 mm (19") level should be closed off with blanking plates. Thus, the air will only enter the rear of the server enclosure through the server itself, where it is drawn off by the Liquid Cooling Package. The blanking plates are available in various heights, e.g. Model No. 1931.200 for one height unit. The vertical foam sealing strips installed on each side of the server enclosure ensure that the cooled air cannot flow past the 482.6 mm (19") level at the sides. Sealing strips are available for 2 applications and 2 enclosure widths. The respective model numbers are found in section 16 "Accessories".

Are all electrical, water, and power connections correctly made?

Before water is admitted, and, ideally before the ball valves are opened, be sure to check that all connections are properly made. Take particular care to ensure that all quick release fasteners are fully snapped into place.

Is the TS server enclosure equipped with suitable doors?

The LCP Rack operates with closed air circuits. Thus, the cooled server enclosure must largely be hermeti-

cally sealed and equipped with unperforated sheet steel or glass doors on the front and rear.

Exception when using the LCP Inline or the LCP Inline flush:

In this case, both the front / front door and the rear / rear door of the server enclosure must have unrestricted air permeability.

After admitting cold water:

Are all parts and connections water tight?

Please check to be sure that all parts and connections which carry water are water tight. The Liquid Cooling Package is subject to an individual, comprehensive factory test, which also includes checking for leaks. This additional check serves to locate problems, such as possible transport damage, and to prevent greater damage.

Venting of the Liquid Cooling Package

In order to ensure even water circulation through the circuit and effective heat transfer, the Liquid Cooling Package must be vented during commissioning.

After the installation:

We recommend that the following selected parameters be gathered and documented within a short time after installation.

- Inlet temperature
- Return temperature
- Volumetric flow with opened 2-way control valve



Note:

Documenting these parameters helps with error analysis in case malfunctions occur during operation.

Please feel free to contact Rittal if you have further questions or problems:

For malfunctions and repairs

Rittal Service Department

Tel.: +49(0)2772 505-1855

E-mail: RSI@Rittal-Service.com

8 Configuration

8.1 General

Basic configuration of the Liquid Cooling Package, particularly the (one-off) adjustment of the network settings, may be carried out in various ways:

1. HTTP connection via the Ethernet interface
2. Telnet connection via the Ethernet interface
3. Serial connection via a USB cable

The settings are generally made via an HTTP connection. If this is not possible, for example because access via HTTP or HTTPS has been deactivated, we recommend access via a Telnet connection. To this end, as with access via an HTTP connection, the IP address of the CMC III Processing Unit (hereafter referred to as CMC III PU) integrated into the Liquid Cooling Package must be known. If this address is not known, the device may be accessed directly via the USB/serial interface on the front.

The following descriptions assume that the Liquid Cooling Package, and in particular the CMC III PU, are in their delivered state, i.e. that no changes have been made to the basic configuration. In particular, the connection types "HTTP" and "Telnet" must not be blocked.

Note:



The assembly and operating instructions for the CMC III PU 7030.000 contain detailed information on how to connect via a Telnet or serial connection.

8.2 HTTP connection

8.2.1 Making the connection

- Using a network cable, connect the device to your computer via the Ethernet interface (fig. 39, item 3).

Note:



Depending on your computer, you may need to use a crossover cable.

- Change your computer's IP address to any address within the range 192.168.0.xxx, e.g. **192.168.0.191**. The device's preset address **192.168.0.190** must not be used.
- Set the subnet mask to the value **255.255.255.0**.
- If applicable, switch off the proxy server in the browser to facilitate a direct connection to the device.
- In the browser, enter the address **http://192.168.0.190** (fig. 54, item 1). The log-on dialogue for registering the device will appear.

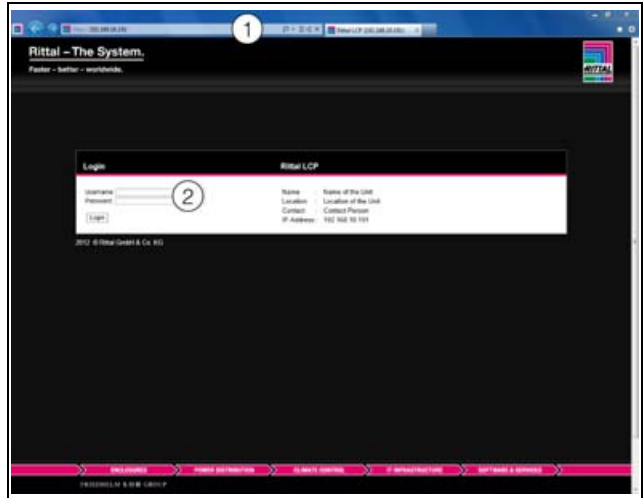

Fig. 54: Log-on screen with an HTTP connection

- Log in with the username **admin** and the password **admin** (fig. 54, item 2).

The overview window for the device will appear (fig. 55).

8.2.2 Changing the network settings

As a general rule, during the course of commissioning, the network settings of the CMC III PU will only need to be changed once, so that it is linked into your network structure.

- In the left-hand section of the overview window (navigation area), click on the **Processing Unit** entry (fig. 55, item 3) and in the right-hand section (configuration area), click on the **Configuration** tab (fig. 55, item 4).



Fig. 55: Adjusting the TCP/IP settings

- In the group box Network, click on the TCP/IP button (fig. 55, item 5).

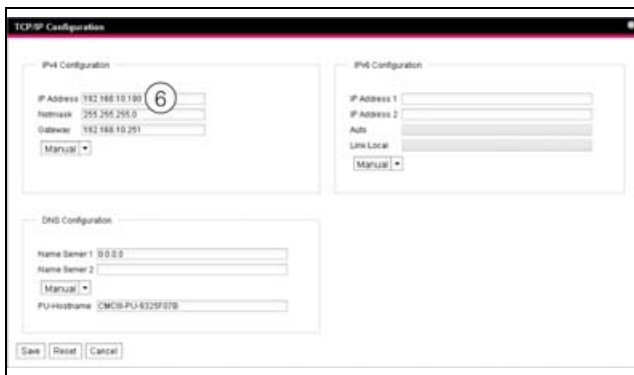

Fig. 56: Adjusting the TCP/IP settings



Note:

The following sections describe in detail how to make the setting for the IPv4 protocol. Further notes regarding the TCP/IP configuration are contained in the assembly and operating instructions for the CMC III PU 7030.000.

- In the TCP/IP Configuration window, change the device's IP address in the IPv4 Configuration group box to an address permitted in the network (fig. 56, item 6).
- If necessary, correct the settings for the subnet mask and the gateway.
- Alternatively, select the "DHCPv4" setting instead of "Manual" for automatic IP allocation.
- Click on the **Save** button to change your settings.



Note:

If the **Save** button cannot be clicked, an incorrect entry has been made. In such cases, check your entries and correct them.

- Change the network settings of your computer to the original IP address and subnet mask values.
- Disconnect the network cable from your computer.
- Using a network cable, connect the device to your computer via the Ethernet LAN (fig. 39, item 3).



Note:

If you have activated automatic IP allocation ("Use DHCP" setting is activated), the IP address of the CMC III PU may be viewed via the USB interface (see the assembly and operating instructions for the CMC III PU 7030.000).

8.2.3 Changing the measurement units



Note:

After any adaptation of the units, all temperature values and flowrates of the Liquid Cooling Package are set to the default values. Consequently, you should set the units (once) as desired and the limit values specified only on completion. If the units should be changed subsequently, note all setting values of the LCP so you can restore them manually.

The measurement units used may be converted from "°C" to "°F" and from "litres" to "gallons".

After registering on the Liquid Cooling Package (see section 8.2.1 "Making the connection"), the Web interface for device operation is displayed.

- In the left-hand section of the overview window, click on the **Processing Unit** entry and in the right-hand section, click on the **Configuration** tab.
- In the group box **System**, click on the **Units and Languages** button.
- In the **Units and Languages Configuration** window in the group box **Units**, under the "Temperature Format" dropdown list, select the entry "Fahrenheit" if preset to "Celsius", and vice versa.
- In the dropdown list "Volume Format", select the entry "Gallon" if preset to "Litre", and vice versa.
- Click on the **Save** button to change your settings.



Note:

While the units are being converted, the Liquid Cooling Package switches to failsafe mode.

8.2.4 LCP configuration

The basic settings for the Liquid Cooling Package are defined in the **Cooling System** group frame. To do this, call the appropriate dialogue by clicking each of the **Air Configuration**, **Water Configuration** and **General Configuration** buttons.

A password must be entered to gain access to the configuration settings. This password consists of the term "RittalLcp" and the directly suffixed serial number of the installed CMC III PU. The serial number is also displayed on the website.

- In the left-hand section of the overview window, click the **Processing Unit** entry and in the right-hand section, click the **Configuration** tab.
- In the **System** group frame, click the **Details** button. The serial number is displayed in the "Serial number" field in the **Details Configuration** dialogue.

For example, if the serial number is "12345678", the associated password is "RittalLcp12345678".

8 Configuration

To configure the LCP:

- Click the required button in the **Cooling System** group frame.



Caution!
Access to the LCP settings is password-protected.
Changes to the configuration are for service purposes only and for setting key operating parameters, which should only be carried out by Rittal service personnel.

- To gain access to the LCP configuration, enter the password in the **Password required** dialogue. The appropriate dialogue for the selected button appears, e.g. the **LCP Air Configuration Dialogue** in which the associated parameters are listed.

LCP Air Configuration Dialogue

Parameter	Explanation
Min. Fan Speed	In the "Automatic", "Manual" and "Minimum" operating modes, the fans will at least run at this set speed. "Automatic" operating mode In automatic mode, the fans are controlled to the temperature difference between the server outlet temperature and the adjustable setpoint. If this difference is less than or equal to the "DtMin" value, the fans will run at the minimum speed set here. "Minimum" operating mode All fans will always run at the minimum speed set here. "Manual" operating mode If a speed is entered which is less than the minimum speed set here, the value is automatically corrected to the minimum speed. Exception: If a speed of "0%" is entered, the fans will be switched off. Preset value: 20
dT min. Fan Speed	The fans operate at the lowest fan speed below this temperature difference (see parameter "Min. Fan Speed"). Preset value: 5. Linear fan control occurs in the range between the "dT min. Fan Speed" and "dT max. Fan Speed" values.
dT max. Fan Speed	The fans operate at the highest fan speed above this temperature difference (100%). Preset value: 15. Linear fan control occurs in the range between the "dT min. Fan Speed" and "dT max. Fan Speed" values.

Tab. 5: Settings in the **LCP Air Configuration Dialogue**

Parameter	Explanation
Maximum Fan Speed	Maximum fan speed. The value "3650" must be entered here for the LCP units. If a different value is entered, incorrect values for the speeds will be returned and device malfunction results.
Fan1...Fan6	If fan monitoring is deactivated, only the monitoring of the fans is deactivated. The fans themselves will continue to run even after monitoring has been deactivated. The fan symbols will be greyed out, both in the graphical representation on the web interface and on the optional display with touch function. The display of the speed values changes to "--". In the tree structure, the speed values will be set to "0", and the status of the corresponding fan changes to "Inactive".
Fan Control Mode	This setting allows you to determine whether the fans in "Automatic" mode are controlled by the average of the server outlet temperature ("Average Temperature" setting) or the maximum value ("Maximum Temperature" setting).

Tab. 5: Settings in the **LCP Air Configuration Dialogue**

LCP Water Configuration Dialogue

Parameter	Explanation
Leakage Mode	This sets the required response of the control valve in the event of a leak: Emergency: The valve closes completely in the event of a leak. The fans are switched off for 15 seconds and the doors of the server enclosure possibly opened. After expiration of this time, the fans are restarted and then turn with the set minimum speed. Only Alarm: Only an alarm message is sent in the event of a leak. If the average of the server inlet or server outlet temperature is subsequently invalid, the fans will operate at 100% speed. The control valve also opens completely (100%). If both temperature values are valid, the Liquid Cooling Package continues to control in the previously set operating mode. The settings for the "Command" variables for the fans (Full, Minimum or Off) are accepted in both modes.
Sensor Rate	If a SIKA sensor is deployed in the LCP, the pulse rates of the sensor that correspond to a flowrate of one litre must be set here (e.g. 77 pulses/litre).

Tab. 6: Settings in the **LCP Water Configuration Dialogue**

Parameter	Explanation	Parameter	Explanation
Sampling Time	The time delay for the control valve in seconds.	Flowmeter	If the flowmeter is deactivated, the flowmeter is greyed out and replaced by "--" in both the graphical display on the web interface and on the optional display with touch function. In the tree structure, the value of the cooling capacity is set to "0" and the flowrate status is "n.a.". If there are customer-specific control components connected upstream of the Liquid Cooling Package, the water sensors for inlet and return, the flowmeter and the control valve must be physically removed from the unit. Otherwise, the internal control components will continue to be regulated.
P	The parameter for setting the proportional amount of the PID control algorithm. The setting is made as percentage.	Control Valve	If the control valve is deactivated, the flowmeter is greyed out and replaced by "--" in both the graphical display on the web interface and on the optional display with touch function. In the tree structure, the value is set to "0". Similarly, the control valve status changes to "n.a.". If there are customer-specific control components connected upstream of the Liquid Cooling Package, the water sensors for inlet and return, the flowmeter and the control valve must be physically removed from the unit. Otherwise, the internal control components will continue to be regulated.
I	The parameter for setting the integral proportion of the PID control algorithm. The setting is made in seconds.	System Warning min. Flow	Flowrate of cooling water. If this is exceeded, an error message will be produced with the closed control valve. This value monitors the control valve. If the setpoint of the control valve is 0% and the measured flowrate is greater than the value entered here, an error message from the control valve will be displayed (error control valve). Please note the following: in devices 3311.130/230/530/540, flowrate measurement starts at 5 l/min. For these devices, a slightly higher value, e.g. 7 l/min, should be set, allowing for a certain tolerance. For devices 3311.260/560, flowrate measurement starts at 10 l/min. Here too, a slightly higher value should be set, such as 13 l/min. If the value is set to "0", monitoring is deactivated. Setting range: 0...50 l/min
D	The parameter for setting the differential proportion. The setting is made in proportion per second.		
Cw Value	The specific thermal capacity of the cooling medium. This value needs to be adjusted only if the cooling medium used is changed.		
Valve Min. Value	Analogous to the minimum fan speed (parameter "RegParMinDrz"), a permanent opening of the control valve for all operating modes may be set here. This setting guarantees a minimum flow at all times, whereby the control system is able to react more spontaneously to sudden capacity increases. "Automatic" operating mode The control valve is always opened at least to the value set here. Exception: In case of leaks, if the "0" setting is selected (= Emergency), the valve is closed completely (see parameter "Leakage Mode"). "Minimum" operating mode The control valve is always opened at least to the value set here. "Manual" operating mode If the operator enters an opening value for the control valve which is less than the minimum opening set here, the value is automatically corrected to the minimum opening.		
Water Sensors	If the temperature sensors for the water inlet and water return are deactivated, the display is greyed out and replaced by "--" in both the graphical display on the web interface and on the optional display with touch function. In the tree structure, the temperature values will be set to "0"; the status of the variables is set "n.a.". If there are customer-specific control components connected upstream of the Liquid Cooling Package, the water sensors for inlet and return, the flowmeter and the control valve must be physically removed from the unit. Otherwise, the internal control components will continue to be regulated.		

Tab. 6: Settings in the **LCP Water Configuration Dialogue**

Tab. 6: Settings in the **LCP Water Configuration Dialogue**

8 Configuration

EN

Parameter	Explanation
System Warning min. Valve	This value monitors the flowmeter, and can be set within the range 0% to 100%. Flow monitoring responds to a comparison between the current valve setting and the above-mentioned value for the "System Warning min. Flow" parameter. If the current valve setting exceeds the value entered here for "System Warning min. Valve", a 3-minute timer will start. Once the timer has expired, the currently measured flowrate is then compared with the "System Warning min. Flow" parameter. If the actual flowrate is smaller, an error from the flowmeter will be displayed. If the value is set to "0", monitoring is deactivated.

Tab. 6: Settings in the **LCP Water Configuration Dialogue**



Note:

Because the percentages affect both the speed and the accuracy of control, the default values for the PID control algorithm should be changed only in exceptional cases.

Example of the parameters System Warning min. Flow and System Warning min. Valve

- Value for "System Warning min. Flow": 5
- Value for "System Warning min. Valve": 50

The following checks are carried out based on these values:

- If the setpoint of the control valve is 0% and the measured flowrate is greater than 5 l/min (System Warning min. Flow), the error "error control valve" will be displayed.
- If the setpoint of the control valve is more than 50% (System Warning min. Valve) and the measured flowrate is less than 5 l/min (System Warning min. Flow), "error flow meter" will be displayed.

LCP General Configuration Dialogue

Parameter	Explanation
Setpoint by Display	Enable option for setting the server inlet temperature via the optional display with touch function on the Liquid Cooling Package (see section 9.2.3 "Operation in stand-alone mode"); Allowed: Settings may be entered via the optional display with touch function. Blocked: Settings cannot be entered via the optional display with touch function. The "Setpoint" entry on "Settings" screen is shown in red, whilst the buttons for adjusting the setpoint on the "Setpoint" screen are hidden.
Door Opening by Display	Enable option for unlocking the doors with an installed "Door Control Unit" (automatic door opening) via the optional display with touch function on the Liquid Cooling Package (see section 9.2.3 "Operation in stand-alone mode") when firmware version < 3.03.00 is deployed: Allowed: The doors may be opened via the optional display with touch function. Blocked: The doors cannot be opened via the optional display with touch function. The "Doors" entry on the "Settings" screen (fig. 66) is shown in red, as are the buttons for opening the doors on the "Doors" screen (fig. 67).
Door1... Door4	Deactivation causes the corresponding door to be hidden on the "Doors" screen, so that it cannot be opened via the optional display with touch function (see section 9.2.3 "Operation in stand-alone mode").
Control Modes Save	If this option is activated, the control modes set for the fan and water control are transferred again automatically after a system restart. If this option is deactivated, the control modes are set to the "Automatic" setting after a system restart.

Tab. 7: Settings in the **LCP General Configuration Dialogue**

8.2.5 Settings

All other setting options for the Liquid Cooling Package are described in section 9 "Operation".

9 Operation

9.1 Description of operating and display components

9.1.1 Control unit hardware for the Liquid Cooling Package

The control unit of the Liquid Cooling Package is a CMC III Processing Unit. The fan module supplies actual values for server in and server out temperatures, while the water module supplies actual values for flowrate, valve setting and temperatures of the inlet and return. This information is also processed by the control unit (CMC III Processing Unit). The setpoint for the valve and fan is based on the actual values supplied.

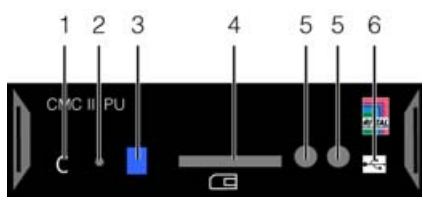

Fig. 57: Liquid Cooling Package control unit (CMC III PU) – front

Key

- 1 "C" button for acknowledging messages
- 2 Concealed reset button
- 3 Multi-LED for status display
- 4 SD card insert
- 5 Integral infrared access sensor
- 6 Mini USB connection for configuration

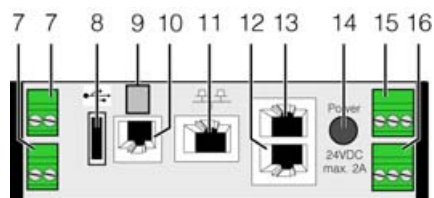

Fig. 58: Liquid Cooling Package control unit (CMC III PU) – rear

Key

- 7 Digital inputs (2 pieces), per 24 V $\overline{=}$, 10 mA
- 8 USB master connection
- 9 Connection of an external temperature sensor (optional)
- 10 Connection for display, GSM or ISDN unit module RJ 12/RS 232, 24 V $\overline{=}$, 500 mA
- 11 Ethernet interface RJ 45 with PoE
- 12 CAN bus connection (daisy chain) for CMC III sensors and CMC III control units, 24 V $\overline{=}$, 1 A
- 13 Second CAN bus connection (for fan and water module), 24 V $\overline{=}$, 1 A
- 14 24 V DC power supply (power pack connection)
- 15 24 V DC power supply (direct connection)
- 16 Alarm relay output (floating contact, max. 24 V DC, 1 A).



Note:

Only the second CAN bus connection (fig. 58, item 13) may be used to connect the fan and water modules.

The device consists of a compact plastic housing in RAL 7035 with vented front in RAL 9005. The following control and display components are set into the front of the CMC II PU:

Control and display component	Explanation
"C" button	Use this button to confirm warnings and alarms.
Multi-LED for status display (steady light)	Green: All devices connected to the CAN bus have the status "OK".
	Orange: At least one device connected to the CAN bus has the status "Warning".
	Red: At least one device connected to the CAN bus has the status "Alarm".
Multi-LED for status display (cyclical)	Green-orange-red: At least one new device has been detected on the CAN bus (status "Detected").
Multi-LED for status display (alternating)	Red-blue: At least one device on the CAN bus has been removed or can no longer be accessed via the CAN bus (status "Lost").
Multi-LED for status display	Blue: The position of at least one device on the CAN bus has been altered (status "Changed").
	Red: Update in progress (so-called heartbeat, alternating long and short).
	White: Update task running for one or more sensors.

Tab. 8: CMC III PU operating and display component

The floating relay output is routed to terminal strip X6 in the rear upper section of the Liquid Cooling Package. An external signal source for alarm signalling may be connected there.

- Please observe the pin assignment of terminal strip X6 (fig. 91).
- Configure the alarm relay after connecting (see assembly and operating instructions of CMC III PU 7030.000).

As well as the built-in sensors, a wide range of sensors, actuators and access monitoring systems may be connected via the CAN bus interface. A detailed list of the entire range of accessories may be found on the website given in section 21 "Customer service addresses".

9.2 Description of operation

9.2.1 General

The control unit of the LCP system carries out the following functions:

- Retrieve all measurements via the CAN bus from the fan modules and the water module (temperature, speed, flow, etc.).
- Evaluate all measurements and generate alarm and warning signals.
- Calculate the thermal output of the inlet and return temperature as well as determine the water flow volume.
- Control air temperature in the server enclosure by regulating the fan speed and the water volume through the heat exchanger.
- Set the setpoint temperature for the incoming cold air (factory setting 20°C).
- Activate an optional display with touch function via an RS-232 interface.
- Display the measurements and settings of parameters and setpoints via the Web interface.
- Retrieve the sensor and setting values via SNMP.



Note:

Further details of operation and the diverse setting options and features of the CMC III PU may be found in the assembly and operating instructions of the CMC III PU 7030.000.

The measurements supplied by the individual modules are evaluated by the control unit, and warning and alarm signals are generated where applicable. If a new warning or alarm occurs, the internal beeper communicates this. At the same time, the alarm relay is switched. This acoustic alarm may be cleared by pressing down the clear button "C" briefly. The exact cause of the malfunction can be displayed in plain text as an alarm or warning message on the connected optional graphical display with touch function (see section 11.2 "Messages on the display").



Note:

After connecting for the first time or following repair work, it is possible that the Liquid Cooling Package will operate in emergency operation mode.

In order to switch the device to normal operation (control operation), briefly press the "C" button (fig. 57, item 1) once.



Note:

In emergency operation, device cooling is ensured even if there are malfunctions inside the unit. All fans will then operate at 100% output, and the control valve will open completely.

Design of the temperature control circuit

The actual temperature values of the cold air on the air input side (server-in temperature) supplied by the three temperature sensors on the heat exchanger are used to control the air which is blown into the server enclosure. The mean is calculated from the actual temperature values. The control unit constantly compares this (average) actual temperature with the setpoint temperature. If the setpoint temperature is exceeded, the control unit attempts to maintain a constant temperature by opening and closing the control valve. The control valve is only kept closed (or set to the value stored in the parameter "MinValvePosition") if the actual temperature falls below the "setpoint temperature" value, i.e. cold water no longer flows through the heat exchanger. Additionally, the temperature difference between the set temperature and the air expelled on the server outlet side (server-out) is used to determine and control the fan speed. The temperature values of the sensors on the server outlet side may either be averaged, or the maximum temperature is used (see section 8.2.4 "LCP configuration"). The setpoint speed for the fans and the control valve setting are sent to the connected control units via the CAN bus. Up to four additional standard sensors may be connected to the control unit (CMC III PU) to monitor additional physical parameters of the Liquid Cooling Package. To this end, the sensors are connected to the first CAN bus connection on the rear of the control unit (fig. 58, item 11) and configured via the Web interface.

Information about a wide range of additional sensors may be found in section 16 "Accessories".

9.2.2 Acknowledging messages

Generally speaking, there are three different ways of acknowledging messages:

1. By briefly pressing the "C" button on the CMC III PU. This confirms all alarm messages simultaneously.
2. By selecting a message with the right mouse button in the message display and clicking on the "Acknowledge Alarm" or "Acknowledge Devices" entry

with the left mouse button in the context menu. If an alarm message has been selected, "Acknowledge Alarm" confirms only the currently selected message.

If a message concerning a configuration change has been selected, "Acknowledge Devices" confirms all related messages jointly.

- By clicking with the right mouse button on a component entry and clicking with the left mouse button on the "Acknowledge Alarm" or "Acknowledge Devices" entry in the context menu. This can be used to confirm pending alarm messages for that particular component or all configuration changes.

9.2.3 Operation in stand-alone mode

In stand-alone mode, the Liquid Cooling Package can be operated via the display with touch function optionally mounted on the front door. The display with touch function may be ordered as an accessory (see section 16 "Accessories").



Fig. 59: Display with touch function

The user interface of the display with touch function allows the user to navigate between the individual menu options of the Liquid Cooling Package controller using software-controlled buttons.

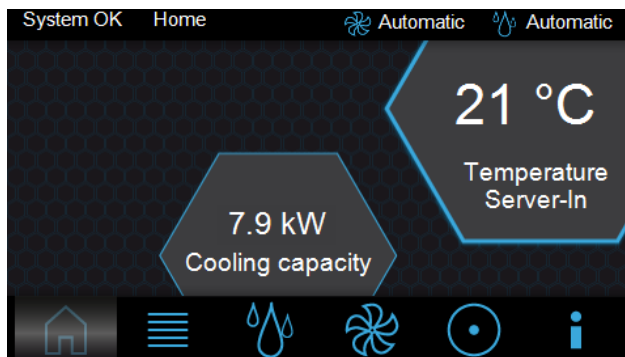

Fig. 60: "Home" screen

On the main screen, the mean of the 3 server-in temperatures of the sensors on the heat exchanger is displayed, together with the current cooling capacity.

The current status of the Liquid Cooling Package, the name of the screen and the current control mode of the fan and water control are always displayed in the title line of each screen on the display.

Depending on the current status of the Liquid Cooling Package, warnings (see fig. 61) and/or alarm messages (see fig. 62) may also be output here. Details of pending messages may be viewed on the "Alarm list" screen (see fig. 73).

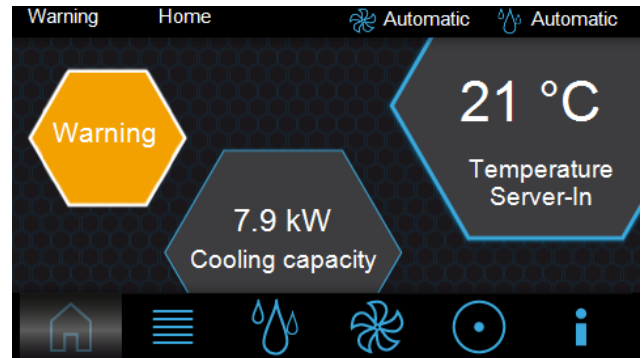

Fig. 61: "Home" screen with warning message

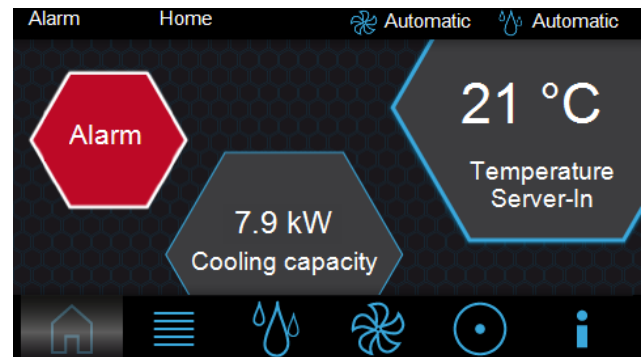

Fig. 62: "Home" screen with alarm message

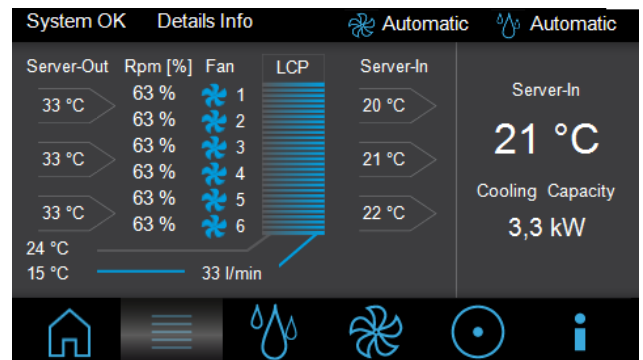

Fig. 63: "Details" screen

The following information is displayed on the "Details" screen

- 3 x server outlet temperature of sensors (server-out)
- 3 x server inlet temperature of sensors (server-in)
- Speed of individual fan modules as a % of maximum speed (rpm)
- Water inlet and return temperature in °C
- Actual setting of control valve
- Cooling water flow rate in l/min

9 Operation

EN

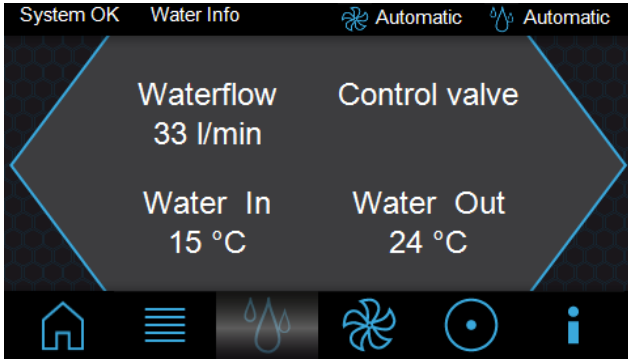

Fig. 64: "Water Info" screen

The following information is displayed on the "Water Info" screen

- Cooling water flow rate in l/min (waterflow)
- Actual setting of control valve
- Water inlet (water in) and water return (water out) temperature in °C

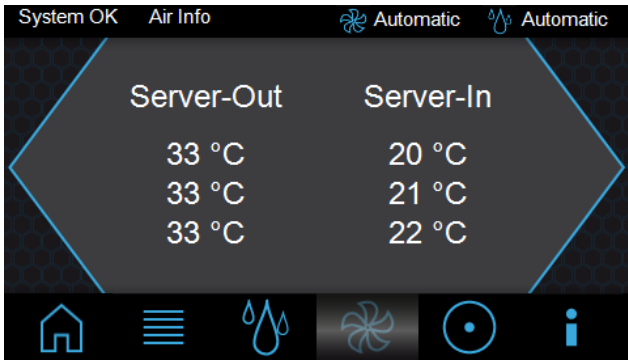

Fig. 65: "Air Info" screen

The following information is displayed on the "Air Info" screen

- 3 x server outlet temperature of sensors (server-out)
- 3 x server inlet temperature of sensors (server-in)

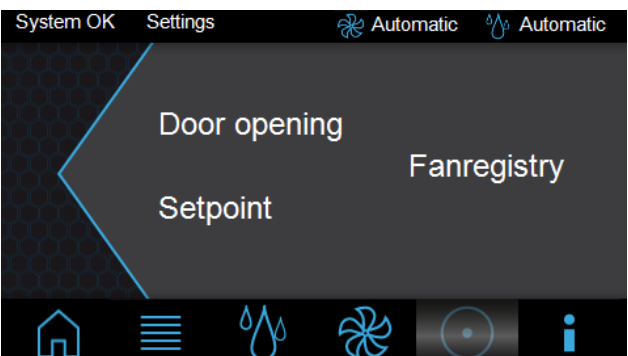

Fig. 66: "Settings" screen

The following selection options are available on the "Settings" screen:

- Door opening (with installed option "Automatic door opening")
- Setpoint
- Fan registry

By selecting one of the points, a new screen page will open.



Note:

In order to prevent access by unauthorised individuals, access to setting options for the server inlet temperature setpoint and opening of the doors may be blocked. Further information may be found in section 8.2.4 "LCP configuration".

The "Doors" screen differs depending on which firmware version is installed on the display.

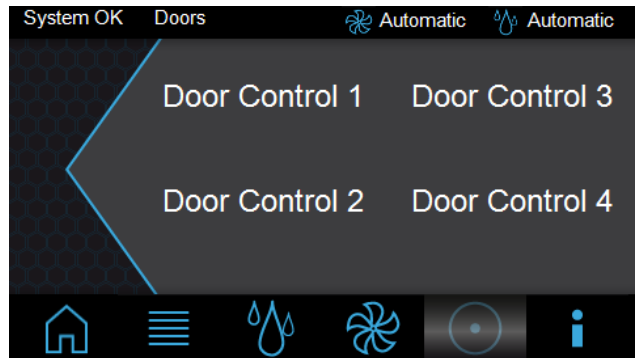

Fig. 67: "Doors" screen (Firmware < 3.03.00)

Firmware version < 3.03.00:

The number of defined door exits is shown on the "Doors" screen. By selecting an entry, e.g. "Door 1", the door magnets on this door output are deactivated for 10 seconds and the door opens. Once this period has expired, the magnet is re-energised.

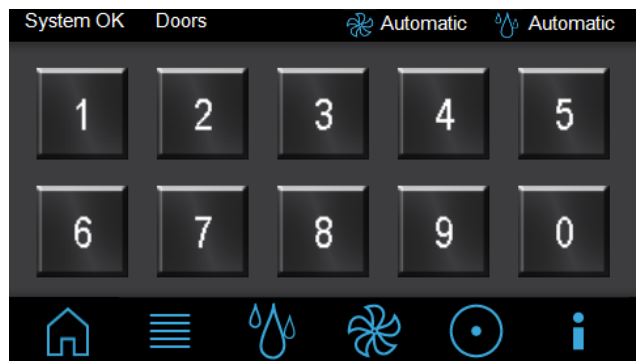

Fig. 68: "Doors" screen (Firmware ≥ 3.03.00)

Firmware version ≥ 3.03.00:

The buttons from "1" to "0" are always displayed on the "Doors" screen. The buttons are assigned to the door magnets with a virtual device (see section 9.7 "Virtual devices"). After clicking a button, e.g. "1", the door magnets for the door output associated with this button are deactivated for 10 seconds and the door opens. Once this period has expired, the magnet is re-energised.

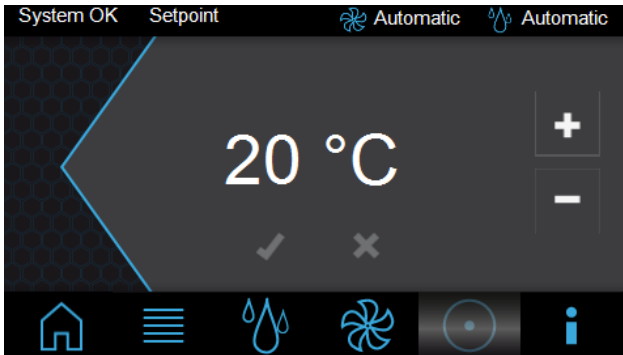

Fig. 69: "Setpoint" screen

On the "Setpoint" screen, you can define the setpoint for the server-in temperature.

- Increase the displayed value by pressing the "+" key, or reduce it by pressing the "-" key.
- Confirm the value by pressing the "✓" key.
- If you do not wish to accept the change, press the "✗" key.

After selecting the "Fan Registry" entry, the "Keypad" screen will open.

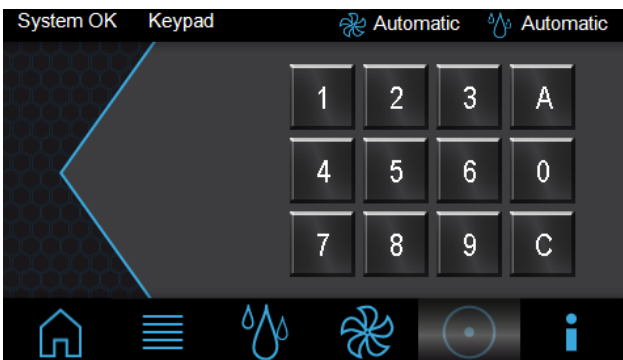

Fig. 70: "Keypad" screen

The following selection options are available:

- Number pad (0-9)
- A (Acknowledge)
- C (Correct)
- Enter the serial number using the number pad keys. The serial number is displayed on the "Info" screen (fig. 72) under the "Serial No." entry.
- Confirm your entry using the "A" (Acknowledge) button.

The "Fan Registry" screen will open.

Note:
Entry of the serial number will be retained for 10 minutes. After that, the operator must re-enter it if he wishes to access the "Fan Registry" screen again.

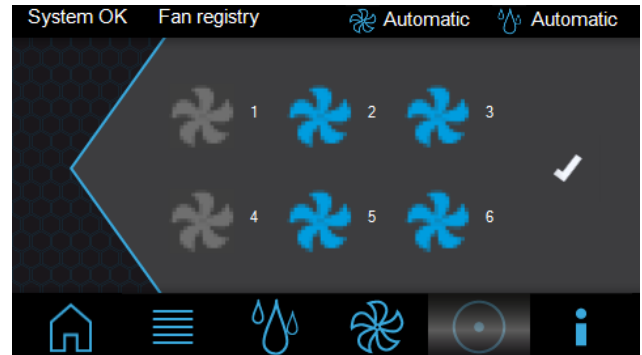

Fig. 71: "Fan Registry" screen

The "Fan Registry" screen is used to activate and deactivate the monitoring of individual fans.

- Activate monitoring of the respective fan by clicking on the grey fan symbol, and deactivate monitoring by clicking on the blue fan symbol.
- Confirm the setting by pressing the "✓" key.

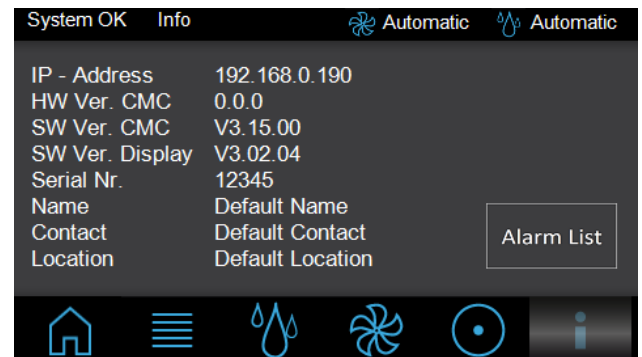

Fig. 72: "Info" screen

Detailed information such as version numbers of the Liquid Cooling Package is displayed on the "Info" screen.

By pressing the "Alarm List" key, the "Alarm List" screen will appear. Here, all pending alarm messages are displayed in plain language.

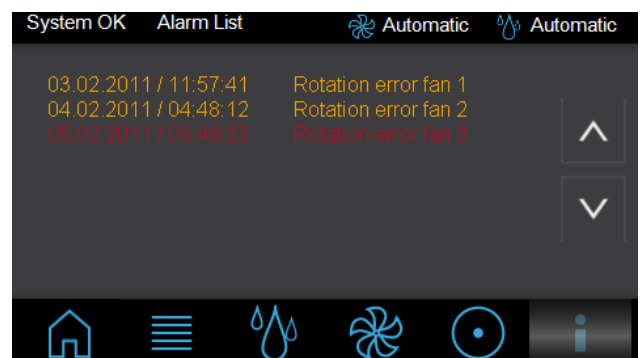

Fig. 73: "Alarm List" screen

Note:
Connect the Liquid Cooling Package to a network for extended setting options (see section 9.3 "Extended options by connecting the Liquid Cooling Package to a network").

9 Operation

EN

9.2.4 Automatic door opening, LCP Rack

In conjunction with the LCP cooling systems, the automatic door-opening feature may be appropriate under certain conditions. With this feature, the doors of the systems are kept closed under normal circumstances and are opened, if necessary, by a mechanism.

Possible reasons for use:

Fire extinguishing

Whole-room fire extinguishing systems are already installed in many existing data centres. However, when rack-based, high-density cooling is used in closed enclosures, the extinguishing gas cannot penetrate into the inside of the rack in the event of a fire. If the doors are automatically opened when needed, the extinguishing gas can flow into the enclosure.

Emergency cooling

In principle, redundancy with respect to cooling can be achieved with the alternating installation of LCPs and racks (fig. 18). If this type of installation is not possible, the internal temperature of the enclosure can rise considerably within a short period of time, e.g. if the cooling water supply fails (e.g. at a heat loss of 15 kW, the temperature will rise from 22°C to 32°C in approx. 90 seconds). However, the rise in the air intake temperature depends greatly on how leak-tight the server rack is.

Emergency cooling can be achieved by the automatic door opening feature. However, the installation location must have adequate air conditioning.

Automatic door opening can be effected in several ways, as follows:

Perforated server rack front door in conjunction with a glass or sheet steel enclosure rear door



If the need arises, only the rear door of the enclosure is automatically opened. The air flows into the interior of the enclosure via the perforated front door, circulates around the installed equipment and exits the system via the open rear door of the enclosure. It is important to ensure that the LCP fans are switched off, otherwise hot air will be blasted in front of the 482.6 mm (19") level in the event of emergency cooling.

If this variant is used, whether for fire extinguishing purposes or for emergency cooling purposes, the installation room must be air-conditioned (ASHRAE conditions, 22°C, 50% rel. humidity). If this method is used for emergency cooling, even higher heat losses in the server rack can be dissipated.

With this method, the escape route is only blocked at the back of the server rack. Unauthorised access, is however, possible through the open rear door. The separate partition between the cooling system and the rack is eliminated.

Solid front door (glass/sheet steel) in conjunction with a solid rear door (glass/sheet steel) of the server rack

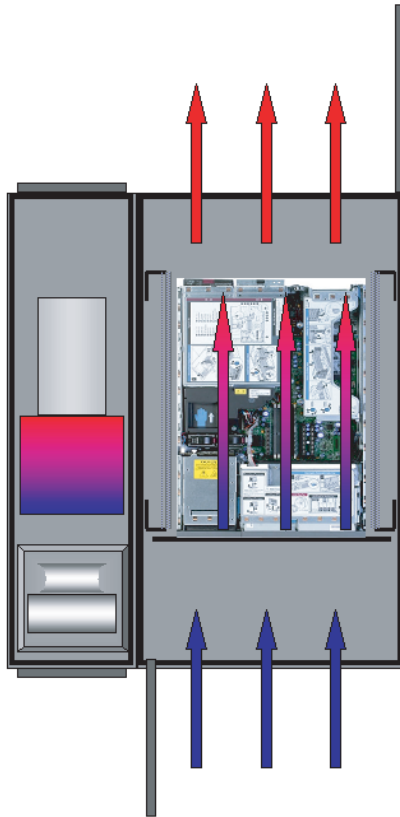

If the need arises, both the front and the rear door are automatically opened. The air flows unhindered into the interior of the enclosure, circulates around the installed equipment and exits the system via the open rear door of the enclosure. It is important to ensure that the LCP fans are switched off, otherwise hot air will be blasted in front of the 482.6 mm (19") level in the event of emergency cooling.

If this variant is used, whether for fire extinguishing purposes or for emergency cooling purposes, the installation room must be air-conditioned (ASHRAE conditions, 22°C, 50% rel. humidity).

If this method is used for emergency cooling, even higher heat losses in the server rack can be dissipated.

With this method, the escape route is blocked at both the front and back of the server rack. Unauthorised access is possible through the open front and rear doors. The separate partition between the cooling system and the rack is eliminated.

If the system used is equipped with an automatic door opening feature, the latter must be activated via the LCP software.

9.3 Extended options by connecting the Liquid Cooling Package to a network

By connecting the Liquid Cooling Package control unit (CMC III PU) to a network, you are able to call up various measurements and warning or alarm messages. These may then be further processed (e.g. via a Web browser, SNMP, etc.). Furthermore, various values can be set via the network and then sent to the control unit.

In the Liquid Cooling Package, the network connection for the CMC III PU is routed to a jack in the upper rear area of the device (fig. 39, item 3). To connect to a network, this jack should be connected to a free jack on a network access using a Category 5 patch cable. The Liquid Cooling Package is preset in the factory to the IP address 192.168.0.190 (see section 8.2 "HTTP connection").

9.4 General operation

9.4.1 Layout of screen pages

After logging on to the Liquid Cooling Package (see section 8.2.1 "Making the connection"), the Web interface for operating the device is displayed. In principle, the screen is divided into four different sections:

1. Top section: Display general information about the device, change the password and log off the current user (see section 9.4.7 "Logging off and changing the password").
2. Left-hand section (navigation area): Select the overall system or respective component for which information is displayed in the right-hand section of the screen (see section 9.4.2 "Navigation area in left-hand section").
3. Right-hand section (configuration area): Display six index tabs (see section 9.4.3 "Index tabs in the configuration area") with input options for all settings.
4. Bottom section: Display messages (see section 9.4.4 "Message display").



Note:

This documentation shows the English screenshots. The descriptions of individual parameters on the Liquid Cooling Packages website likewise use English terminology. Depending on the set language, the displays on the website may be different (see assembly and operating instructions for the CMC III PU 7030.000).



Fig. 74: Layout of screen pages

Key

- 1 General information
- 2 Navigation area
- 3 Configuration area with tabs
- 4 Message display

9.4.2 Navigation area in left-hand section

The overall system including all installed components is displayed in the form of a tree structure in the navigation area of the screen.

At the top of the navigation area is the Processing Unit, i.e. the overall system. The sub-group Real Devices is displayed below the overall system. The CMC III PU, the Liquid Cooling Package itself and maximum four devices and sensors installed as hardware are listed in this group (see assembly and operating instructions for the CMC III PU 7030.000).



Note:
If more than four sensors are installed, they are not displayed on the Liquid Cooling Package website.

Each device can assume different statuses. To allow rapid identification of the current status, the symbol before the respective device is colour-coded:

Symbol	Explanation
	Status "OK". There are no warnings or alarm messages.
	Status "Warning". There is at least one warning message.
	Status "Alarm". There is at least one alarm message.
	Status "OK". The additional information symbol indicates that further status information may be displayed. This symbol is only displayed if the registered user has at least read-only access to the data for that particular device.

Tab. 9: Status display symbols

Symbol	Explanation
	Status "Detected". The sensor has recently been added and not yet confirmed. This sensor must be confirmed by pressing the "C" button on the CMC III PU or via the Web interface.
	Status "Lost". Communication with a sensor is no longer possible. The connection must be checked. Alternatively, the sensor can also be logged off by confirming.
	Status "Changed". The sequence of sensors has been altered and not yet confirmed. This configuration change must be confirmed by pressing the "C" button on the CMC III PU or via the Web interface.

Tab. 9: Status display symbols

9.4.3 Index tabs in the configuration area

Six index tabs are displayed in the right-hand section of the screen:

1. Observation: Current data of the Liquid Cooling Package or connected devices (see section 9.5 "Observation index tab").
2. Configuration: Configuration of basic settings (see section 9.6 "Configuration index tab").
3. Logging: Message archive about the Liquid Cooling Package and connected devices (see assembly and operating instructions for the CMC III PU 7030.000).
4. Tasks: Creating links between different values and related actions (see section 9.8 "Tasks").
5. Charts: Charts for the chronological trend of the variable values (see assembly and operating instructions for the CMC III PU 7030.000).
6. Dashboards: Create different views as dashboards (see the assembly and operating instructions of the CMC III PU 7030.000).

The content of the index tabs **Observation** and **Configuration** depends on whether the entire system ("Processing Unit" entry) or an individual component, e.g. "Liquid Cooling Package" entry has been selected in the left-hand section of the screen.

9.4.4 Message display

Current pending messages are displayed in the bottom section of the screen. The message display is structured as follows:

1. Timestamp: The date and time when the error occurred (fig. 75, item 1).
2. Severity: Severity of the error. A distinction is made between Warnings and Alarms (fig. 75, item 2).
3. Message: Error message in plain language (fig. 75, item 3).

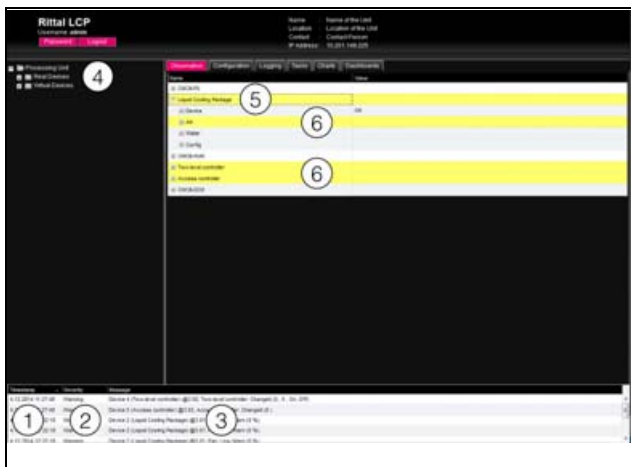

Fig. 75: Layout of message display

Key

- 1 Date and time
- 2 Error category
- 3 Error message in plain language
- 4 Component with error message
- 5 Component
- 6 Parameter

Additionally, errors occurring are displayed as follows:

- Left-hand screen section (navigation area): The symbol in front of the component on which the error occurred is shown in red in the tree view in the event of an alarm message, and yellow in the event of a warning message (fig. 75, item 4).
- Right-hand screen section (configuration area): On the **Observation** index tab, the entire component and the specific parameter to which the warning or alarm applies is shown in red or yellow (fig. 75, items 5 and 6).
- The multi-LED on the front of the CMC III PU is permanently red or orange.
- Depending on the settings, the alarm relay will switch and the CMC III PU will emit an acoustic signal.

If the cause of an error message has been rectified, the corresponding message may be automatically deleted from the message display. The status of the respective component may also be reset, and all other displays triggered by the error may disappear. However, this depends on the chosen alarm configuration (see assembly and operating instructions of the CMC III PU 7030.000). In some cases, error messages and the status may remain in the overview until acknowledged with the "C" button on the CMC III PU (see section 9.2.2 "Acknowledging messages").

If the device configuration is permanently altered, e.g. a new sensor is connected to the CMC III PU, this is likewise output in the message display as an error message, type "Alarm". Additionally, in such cases, the multi-LED in the front of the CMC III PU will cyclically flash green – orange – red. Such configuration changes are not delet-

ed from the message display until confirmed by the operator (see section 9.2.2 "Acknowledging messages").

Example: Increased temperature

If the temperature sensor integrated into the CMC III PU measures a temperature above the value stored as "SetPtHighWarning", a warning message will be emitted.

In such cases, the display will change as follows:

- The symbol in front of the CMC III PU component in the navigation area will be coloured yellow.
- On the **Observation** index tab, the entire component and the lines "Temperature" and "Status" will be coloured yellow. The "High Warn" warning message will also be emitted.
- A corresponding warning message will appear in the message display.

If the temperature drops back below the "SetPtHighWarning" value plus the hysteresis value (see section 20 "Glossary"), the message may be automatically deleted from the message display and the relevant status displays reset, depending on the alarm configuration (refer to the assembly and operating instructions of the CMC III PU 7030.000).

9.4.5 Other displays

The operator's entries in the Web interface are automatically checked against preset rules, depending on the parameter entered. This means that changes can only be saved if all values have previously been correctly entered in a dialogue.

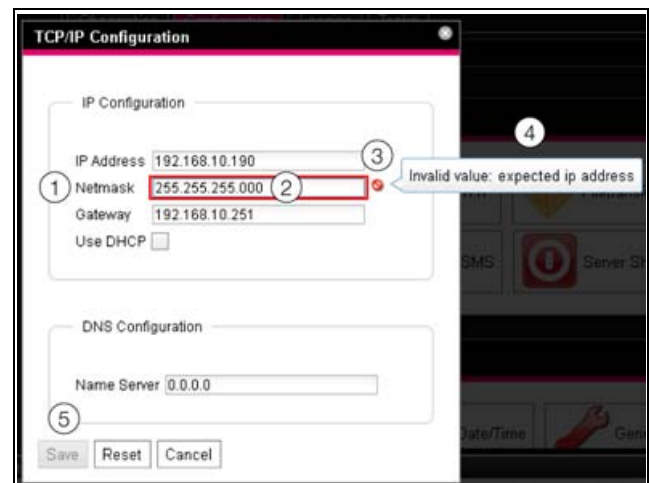

Fig. 76: Display of an incorrect entry

Key

- 1 **Netmask** field
- 2 Incorrect entry
- 3 Prohibited symbol
- 4 Note
- 5 Inactive button

The following changes occur in case of an incorrect entry in the dialogue (illustrated here by the example of an incorrectly entered IP address):

9 Operation

EN

- A red "prohibited symbol" (fig. 76, item 3) appears after the incorrect entry (fig. 76, item 2) in the **Netmask** field (fig. 76, item 1)
- By holding the mouse pointer over the prohibited symbol, additional information about the error will appear (fig. 76, item 4).
- The **Save** button is deactivated (fig. 76, item 5), so that the current values cannot be saved.

Proceed as follows to rectify the error:

- Using the information provided, identify the precise nature of the incorrect entry.
In this particular example, the value entered does not comply with the format of an IP address.
- Correct the defective value, e.g. by entering the value "255.255.255.0".
The "prohibited symbol" is masked out and the **Save** button is activated.
- Save the settings by pressing the **Save** button.

9.4.6 Changing parameter values

Different parameters for the currently selected component are displayed in the list view of the **Observation** index tab. Some of these parameters can be adjusted by the operator, while others have fixed values assigned to them.

For all parameters that can be changed, an "Edit" symbol in the form of a stylised notepad and pen will appear after the respective parameter if the mouse pointer is placed in the relevant line (fig. 77, item 1).



Fig. 77: Editable parameter with "Edit" symbol

Key

- 1 "Edit" symbol

If this symbol does not appear, the corresponding value cannot be altered.

Example:

- In the navigation area, select the entry "Liquid Cooling Package".
- In the right-hand part of the screen, select the **Observation** index tab.
- One after the other, open the "Liquid Cooling Package" and "Device" entries by clicking on the "plus" symbol in front of the entry (fig. 78, item 1).

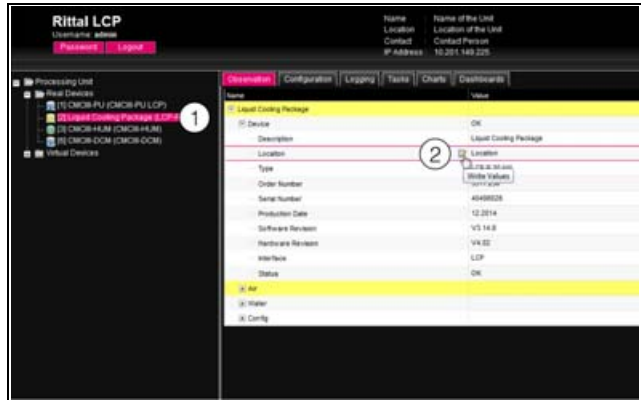

Fig. 78: Selecting an individual parameter

Key

- 1 Liquid Cooling Package and Device entries
- 2 "Location" parameter

- Position the mouse pointer at the end of the first column in the "Location" line (fig. 78, item 2).
An "Edit" symbol will appear, and the mouse pointer will change to a "Hand" symbol.
- Click on the "Edit" symbol.
A "Write Values" dialogue will appear with the parameter "Device.Location".

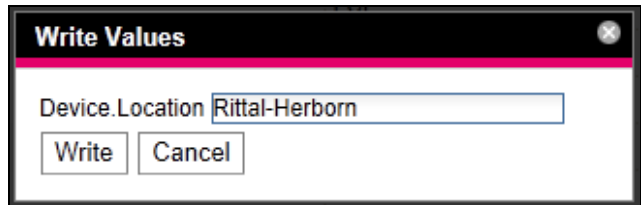

Fig. 79: "Write Values" dialog

- Here, enter the location of the Liquid Cooling Package.
- Confirm your entry by clicking on the **Write** button.
The dialogue box will close and the new value will appear in the "Location" line.
- Next, position the mouse pointer at the end of the first column in the "Type" line.
In this case, no "Edit" symbol will appear, i.e. the value stored here (e.g. "LCP-I 30 kW") cannot be altered.
You may wish to amend several values simultaneously, or may not know the entry under which the required parameter is stored. In such cases, all editable parameter values of subordinate entries can also be displayed in one window.
- Simply open the "Liquid Cooling Package" entry by clicking on the "plus" symbol in front of that entry (fig. 80, item 1).
- Position the mouse pointer at the end of the first column in the "Location" line (fig. 80, item 2).
An "Edit" symbol will appear, and the mouse pointer will change to a "Hand" symbol.

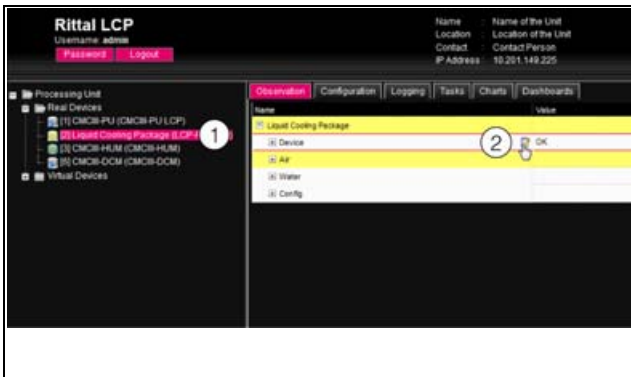

Fig. 80: Selecting multiple parameters

Key

- 1 Device entry
- 2 "Edit" symbol

- Click on the "Edit" symbol.

The "Write Values" dialogue will appear with the two parameters "Device.Description" and "Device.Location".

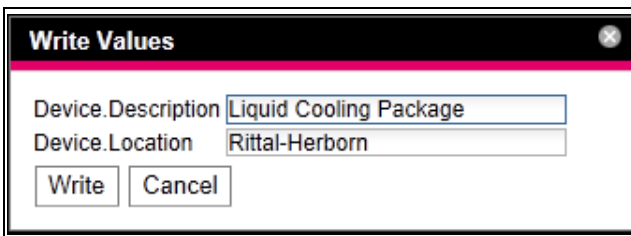

Fig. 81: "Write Values" dialogue with multiple parameters

- Store the amended values for all required parameters.
- Confirm your entries by clicking on the **Write** button.

The dialogue is closed.

- Open the "Device" entry by clicking on the "plus" symbol in front of it.

All amended values can now be viewed here.

The "Write Values" dialogue shows all parameters which may be amended below the previously selected level. For example, if you click on the "Edit" symbol in the highest level "Liquid Cooling Package", all editable parameters for the entire component will be displayed.

**Note:**

If the number of variables to be amended is too high, an error message will appear. In such case, you will need to move down a level.

9.4.7 Logging off and changing the password

For every user group (and hence for every user), it is possible to set a time after which the user is automatically logged off in case of inactivity (refer to the assembly and operating instructions of the CMC III PU 7030.000). However, a user can also log off via the Web interface.

- Press the **Logout** button in the top left of the screen.

Logout occurs immediately and the login window will appear.

Additionally, every user may change their own password in the Web interface.

- Press the **Password** button in the top left of the screen.

The dialogue "Set new Password for User 'XXX'" will appear.

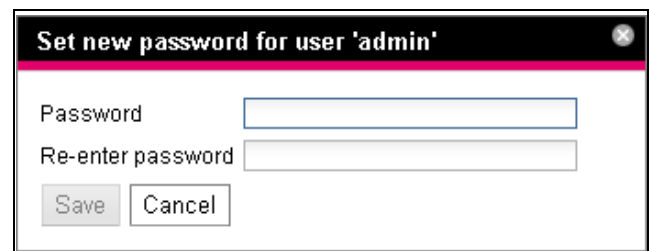

Fig. 82: Changing the password

- Enter the new password in the "Password" line (at least 3 characters) and repeat it in the "Re-enter Password" line.

Provided both entries match, you will need to use the new password the next time you log into the system.

**Note:**

Irrespective of this amendment, a user with appropriate rights can also alter the passwords of all users via the user administration feature (refer to the assembly and operating instructions of the CMC III PU 7030.000).

9.4.8 Reorganising the connected components

When new components are installed on the CMC III PU, these are inserted into the next free space in the tree structure and allocated a corresponding ID number. Particularly with multiple upgrades and changes in the sequence of connected components, this may result in a lack of allocation between the position of the components in the CAN bus and the corresponding ID number. The "Reorganize" function renumbers all connected components as follows.

1. CMC III PU
2. Liquid Cooling Package (CAN bus 2)
3. Sensor 1 (CAN bus 1)
4. Sensor 2 (CAN bus 1)
5. Sensor 3 (CAN bus 1)
6. Sensor 4 (CAN bus 1)

- In the navigation area, click on the "Processing Unit" entry or any other connected component with the right mouse button.

- With the left mouse button, click on the "Reorganize" entry in the context menu.

A message will appear stating that the components have been renumbered as a result of reorganisation. This may lead to problems when accessing these components, e.g. via SNMP, and access will need to be re-

9 Operation

EN

configured. However, the "Alarm Configuration" of the individual sensors is retained.

The sensors are then registered automatically again on the CMC III PU.



Note:

When reorganising the components, all components with the status "Lost" are removed from the navigation area.

9.5 Observation index tab

All settings for the individual system components are made in the **Observation** index tab, such as limits for warning and alarm messages. The display in the right-hand section of the screen depends on which component was selected in the navigation area.

- If you select the "Processing Unit" entry (top node) in the navigation area, all "Real Devices" will be available for selection in the **Observation** index tab.
- If you select the "Real Devices" entry in the navigation area, all "Real Devices" will likewise be available for selection in the **Observation** index tab.
- If you select a specific component, such as the "Liquid Cooling Package" entry, in the left-hand tree structure, only that component will be available for selection in the **Observation** index tab. Here, you can choose between two display options:

- Tree view: This allows fast, targeted access to individual parameters.
- Graphical representation: This provides a quick overview of the entire Liquid Cooling Package system, such as the status and speed of the fans or temperature values of the server inlet and outlet side.

If, after selecting the "Liquid Cooling Package" level, the subordinate entries "Device", "Air", "Water" etc. are displayed (fig. 83), you can switch to the graphical representation as follows:

- Press the coloured "Graphics" symbol after the "Liquid Cooling Package" entry in the form of a stylised diagram (fig. 83, item 2).

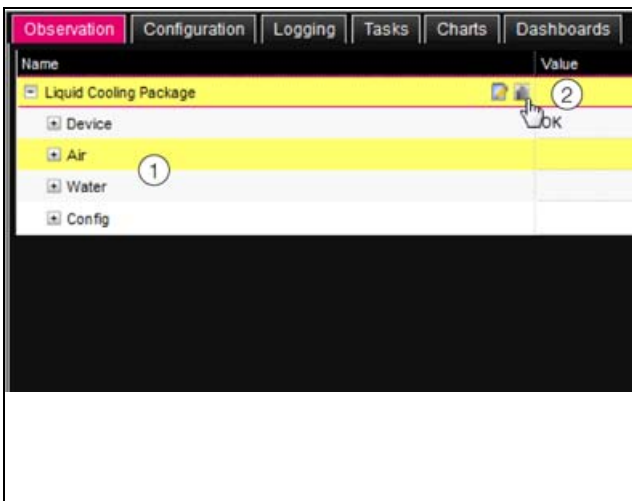

Fig. 83: Tree structure

The display switches to the graphical representation (fig. 84) and all statuses and speeds of the fans and temperature values for the server inlet and outlet temperature as well as the control modes for the fan and water control can be seen at a glance and amended by clicking the graphic (fig. 84, item 2).

After selecting the "Liquid Cooling Package", if graphical representation (fig. 84) is preselected, you can switch to the tree view as follows:

- Click on the greyed "Graphics" symbol after the "Liquid Cooling Package" entry (fig. 84, item 1).

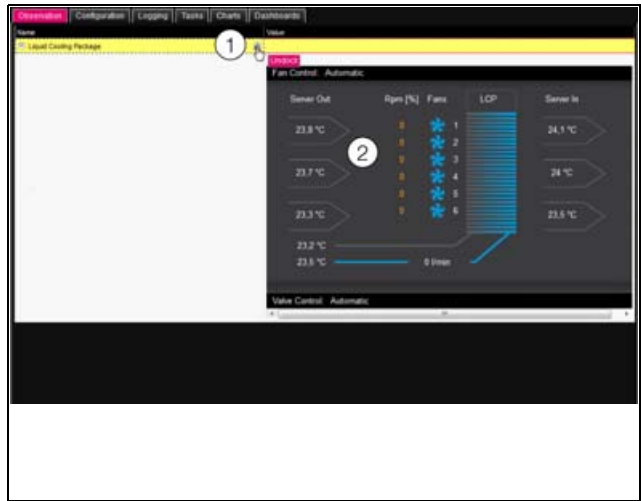

Fig. 84: Graphical representation

The display switches to the tree view (fig. 83) and the individual settings for the Liquid Cooling Package may be selected.

The following descriptions assume that you have selected the tree view.

The following sections 9.5.1 "Device" to 9.5.4 "Config" only contain detailed descriptions of those parameters which may be altered. There are also display values for information purposes.

9.5.1 Device

General settings for the Liquid Cooling Package are carried out at "Device" level.

Parameter	Explanation
Description	Individual description of the Liquid Cooling Package
Location	Installation site of the Liquid Cooling Package

Tab. 10: Settings at "Device" level

Parameters containing detailed information, such as the software and hardware versions used, are also displayed. You should have this information to hand when contacting Rittal with a query, so as to facilitate rapid error diagnosis.

9.5.2 Air

Settings for the fans and sensors for the server inlet and outlet temperatures are carried out at "Air" level.

"Device" level

The following parameters for the control unit of the fan modules may be set at the "Device" level:

Parameter	Explanation
Description	(Detailed) description of the control unit for the fan modules.

Tab. 11: Settings at the "Device" level

The following parameters are also displayed for the control unit:

Parameter	Explanation
Software Revision	Software version of the control unit for the fan modules.
Hardware Revision	Hardware version of the control unit for the fan modules.
Status	Current status of the control unit for the fan modules. "OK": Control unit of the fan modules is connected and operational. "Alarm": Control unit of the fan modules is not connected or not detected.

Tab. 12: Displays at the "Device" level

"Temperature" level

Settings for the installed sensors for the server inlet and outlet temperatures are carried out at the "Temperature" level.

Parameter	Explanation
Description	(Detailed) description of temperature sensors.

Tab. 13: Settings at the "Temperature" level

The following parameters are also displayed for the temperature sensors:

Parameter	Explanation
In-Top	Server inlet temperature, measured at the top temperature sensor.
In-Mid	Server inlet temperature, measured at the middle temperature sensor.
In-Bot	Server inlet temperature, measured at the bottom temperature sensor.
Out-Top	Server outlet temperature, measured at the top temperature sensor.

Tab. 14: Displays at "Temperature" level

Parameter	Explanation
Out-Mid	Server outlet temperature, measured at the middle temperature sensor.
Out-Bot	Server outlet temperature, measured at the bottom temperature sensor.
Status	Current status of temperature sensors. "OK": All temperature sensors connected and operational. "Alarm": At least one connected temperature sensor has failed or is not detected.

Tab. 14: Displays at "Temperature" level

"Server-In" level

Settings for the server inlet temperature are carried out at the "Server-In" level.

Parameter	Explanation
Description	(Detailed) description of server inlet temperature.
Setpoint	Current setting for the server inlet temperature. The system attempts to regulate the server inlet temperature to this value by controlling the flow rate of the control valve.
SetHigh-Alarm	Top limit of the server inlet temperature; an alarm message is emitted if this is exceeded.
SetHigh-Warning	Top limit of the server inlet temperature; a warning message is emitted if this is exceeded.
SetLow-Warning	Bottom limit of the server inlet temperature; a warning message is emitted if this is undercut.
SetLow-Alarm	Bottom limit of the server inlet temperature; an alarm message is emitted if this is undercut.
Hysteresis	Required percentage deviation for a status change if the temperature limit is undercut or exceeded (see section 20 "Glossary").

Tab. 15: Settings at the "Server-In" level

The following parameters are also displayed for the server inlet temperature:

Parameter	Explanation
Average	Mean of the three server inlet temperatures In-Top, In-Mid and In-Bot.

Tab. 16: Displays at the "Server-In" level

Parameter	Explanation
Status	Current status regarding the server inlet temperature. "OK": No limit has been exceeded or undercut. "Alarm": All three temperature sensors have failed. Too Low: "SetLowAlarm" limit undercut. Low Warn: "SetLowWarning" limit undercut. High Warn: "SetHighWarning" limit exceeded. Too High: "SetHighAlarm" limit exceeded.

Tab. 16: Displays at the "Server-In" level

"Server-Out" level

Settings for the server outlet temperature are carried out at the "Server-Out" level.

Parameter	Explanation
Description	(Detailed) description of server outlet temperature.
SetHigh-Alarm	Top limit of the server outlet temperature; an alarm message is emitted if this is exceeded.
SetHigh-Warning	Top limit of the server outlet temperature; a warning message is emitted if this is exceeded.
SetLow-Warning	Bottom limit of the server outlet temperature; a warning message is emitted if this is undercut.
SetLow-Alarm	Bottom limit of the server outlet temperature; an alarm message is emitted if this is undercut.
Hysteresis	Required percentage deviation for a status change if the temperature limit is undercut or exceeded (see section 20 "Glossary").

Tab. 17: Settings at the "Server-Out" level

The following parameters are also displayed for the server outlet temperature:

Parameter	Explanation
Average	Mean of the three server outlet temperatures Out-Top, Out-Mid and Out-Bot.

Tab. 18: Displays at "Server-Out" level

Parameter	Explanation
Status	Current status regarding the server outlet temperature. "OK": No limit has been exceeded or undercut. "Alarm": All three temperature sensors have failed. Too Low: "SetLowAlarm" limit undercut. Low Warn: "SetLowWarning" limit undercut. High Warn: "SetHighWarning" limit exceeded. Too High: "SetHighAlarm" limit exceeded.

Tab. 18: Displays at "Server-Out" level

"Fans" level

Settings for the installed fans are carried out at the "Fans" level.

"All Fans" sub-level

Settings in the "All Fans" sub-level concern all connected fans.

Parameter	Explanation
SetLow-Warning	Bottom limit of the fan speed; a warning message is emitted if this is undercut.

Tab. 19: Settings in the "All Fans" sub-level

Sub-levels "Fan1" to "Fan6"

Settings for the respective fan are carried out in sub-levels "Fan1" to "Fan6".

Parameter	Explanation
Description	(Detailed) description of the respective fan.

Tab. 20: Settings in sub-levels "Fan1" to "Fan6"

The following parameters are also displayed for the fans:

Parameter	Explanation
Rpm	Current speed of the respective fan as a % of maximum speed
Status	Current status of the respective fan. "OK": Fan is connected and operational. "Low Warn": Fan speed is below the "SetLowWarning" limit. "Off": Fan is deactivated. "Inactive": Although fan monitoring is disabled, the fan runs.

Tab. 21: Displays in sub-levels "Fan1" to "Fan6"

9.5.3 Water

Settings for the water circuit are carried out at "Water" level.

"Device" level

The following parameters for the water module may be set at the "Device" level:

Parameter	Explanation
Description	(Detailed) description of the water module.

Tab. 22: Settings at "Device" level

The following parameters are also displayed for the water module:

Parameter	Explanation
Software Revision	Software version of the water module.
Hardware Revision	Hardware version of the water module.
Status	Current status of the water module. "OK": Water module is correctly connected and operational. "Alarm": Water module is not connected or not detected.

Tab. 23: Displays at "Device" level

"In-Temperature" level

Settings for the water inlet temperature are carried out at the "In-Temperature" level.

Parameter	Explanation
Description	(Detailed) description of water inlet temperature.
SetHigh-Alarm	Top limit of the water inlet temperature; an alarm message is emitted if this is exceeded.
SetHigh-Warning	Top limit of the water inlet temperature; a warning message is emitted if this is exceeded.
SetLow-Warning	Bottom limit of the water inlet temperature; a warning message is emitted if this is undercut.
SetLow-Alarm	Bottom limit of the water inlet temperature; an alarm message is emitted if this is undercut.
Hysteresis	Required percentage deviation for a status change if the temperature limit of the water is undercut or exceeded (see section 20 "Glossary").

Tab. 24: Settings at the "In-Temperature" level

The following parameters are also displayed for the water inlet temperature:

Parameter	Explanation
Value	Current water inlet temperature.
Status	Current status regarding the water inlet temperature. "OK": No limit has been exceeded or undercut. "Alarm": The temperature sensor has failed. Too Low: "SetLowAlarm" limit undercut. Low Warn: "SetLowWarning" limit undercut. High Warn: "SetHighWarning" limit exceeded. Too High: "SetHighAlarm" limit exceeded. "n.a.": The sensors for the water inlet and water return temperature are deactivated in the configuration (see section 8.2.4 "LCP configuration")

Tab. 25: Displays at the "In-Temperature" level

"Out-Temperature" level

Settings for the water return temperature are carried out at the "Out-Temperature" level.

The displays are exactly the same as those for the "In-Temperature" level (see the section on the "In-Temperature" level).

"Flowrate" level

Settings for the water flow rate are carried out at the "Flowrate" level.

Parameter	Explanation
Description	(Detailed) description of the water flow rate.
SetHigh-Alarm	Top limit of the water flow rate; an alarm message is emitted if this is exceeded.
SetLow-Alarm	Bottom limit of the water flow rate; an alarm message is emitted if this is undercut.
Hysteresis	Required percentage deviation for a status change if the water flow rate limit is undercut or exceeded (see section 20 "Glossary").

Tab. 26: Settings at the "Flowrate" level

The following parameters are also displayed for the water flow rate:

Parameter	Explanation
Value	Current flow rate of water.

Tab. 27: Displays at the "Flowrate" level

Parameter	Explanation
Status	Current status regarding the water flow rate. "Error": The control valve is open, but only a minimum flow rate is measured. "OK": The flowmeter is correctly connected and operational. "Alarm": The flowmeter is not connected or not detected. Too Low: "SetLowAlarm" limit undercut. Too High: "SetHighWarning" limit exceeded. "n.a.": The flowmeter is deactivated in the configuration (see section 8.2.4 "LCP configuration").

Tab. 27: Displays at the "Flowrate" level

"Control-Valve" level

Settings for the control valve are carried out at the "Control-Valve" level.

Parameter	Explanation
Description	(Detailed) description of the control valve.

Tab. 28: Settings at the "Control-Valve" level

The following parameters are also displayed for the control valve:

Parameter	Explanation
Actual Value	Position of the control valve in %: 0% = valve closed, 100% = valve open.
Status	Current status of control valve. "Error": The control valve is completely closed, but a water flow is still being measured. "OK": The control valve is correctly connected and operational. "n.a.": The control valve is deactivated in the configuration (see section 8.2.4 "LCP configuration").

Tab. 29: Displays at the "Control-Valve" level

"Cooling Capacity" level

Cooling capacity settings are carried out at the "Cooling Capacity" level.

Parameter	Explanation
Description	(Detailed) description of cooling capacity.

Tab. 30: Settings at the "Cooling Capacity" level

The following parameters are also displayed for cooling capacity:

Parameter	Explanation
Value	The calculated cooling capacity of the Liquid Cooling Package. The capacity is calculated from the inlet and return temperatures as well as from the flow values of the cooling water circuit (the value is calculated over approximately one to two minutes).
Status	Current status of cooling capacity. "OK" is always displayed here; no other status is possible.

Tab. 31: Displays at the "Cooling Capacity" level

"Leakage Sensor" level

Leak monitoring settings are carried out at the "Leakage Sensor" level.

Parameter	Explanation
Description	(Detailed) description of leak monitoring.

Tab. 32: Settings at the "Leakage Sensor" level

The following parameters are also displayed for leak monitoring:

Parameter	Explanation
Input	0 = No leaks present 1 = Leak present
Status	Current status of leak monitoring. "OK": No leaks present. "Alarm": Leak present.

Tab. 33: Displays at the "Leakage Sensor" level

"Condensate Sensor" level

Condensate monitoring settings are carried out at the "Condensate Sensor" level.

Parameter	Explanation
Description	(Detailed) description of condensate monitoring.

Tab. 34: Settings at the "Condensate Sensor" level

The following parameters are also displayed for condensate monitoring:

Parameter	Explanation
Input	0 = No condensate present. 1 = Condensate present.
Pump	0 = Condensate pump not active. 1 = Condensate pump active.
Cycles	Operating cycles of condensate pump.

Tab. 35: Displays at the "Condensate Sensor" level

Parameter	Explanation
Duration	Last duty cycle of condensate pump.
Status	Current status of condensate monitoring. "Off": The pump is not running. "On": The pump is running.

Tab. 35: Displays at the "Condensate Sensor" level



Note:
Condensate sensors and condensate pumps are not installed in the factory.

9.5.4 Config

Settings for the operating modes of the fans and control valve are carried out at "Config" level.

"Fans" level

Settings for the operating modes and speeds of the fans are carried out at the "Fans" level.

Parameter	Explanation
Command	Select the operating mode. "Automatic": Fan speeds are determined and automatically regulated according to the server outlet temperature. "Manual": Fan speeds are set manually. "Off": Fans are deactivated. "Minimum": Fans rotate at the preset minimum speed. "Full": Fans rotate at 100%.
Fan	Specification of the fan speed as a % for the operating mode "Manual".

Tab. 36: Settings at the "Fans" level



Note:
In "Manual" operating mode, if the value "0" is entered, the respective fan will be deactivated. By entering a value greater than "0", the respective fan will at least rotate at the preset minimum speed.

"Control-Valve" level

Settings for the operating modes and positioning of the control valve are carried out at the "Control-Valve" level:

Parameter	Explanation
Command	Select the operating mode: "Automatic": The positioning of the control valve is determined and automatically regulated according to the server inlet temperature. "Manual": The positioning of the control valve is set manually. "Off": The control valve is completely closed. "Minimum": The control valve is opened to the preset minimum value. "Full": The control valve is completely opened.
Valve	Positioning of the control valve as a % for the operating mode "Manual".

Tab. 37: Settings at the "Control-Valve" level

9.6 Configuration index tab

The content of the **Configuration** index tab depends on which component was selected in the left-hand section of the tree view.

If the overall system "Processing Unit" (top node) is selected, the following configuration options are available:

- Group frame **Network**
 - TCP/IP
 - SNMP
 - HTTP
 - File Transfer
 - Console
 - SMTP
 - Modbus/TCP
 - Server Shutdown
 - OPC-UA
- Group frame **System**
 - Syslog
 - Units and Languages
 - Details
 - Date/Time
 - General
 - Firmware Update
 - WebCam
 - Display
- Group frame **Security**
 - Groups
 - Users
 - Access Configuration
 - LDAP
 - RADIUS
- Group frame **Cooling System**
 - Air Configuration
 - Water Configuration
 - General Configuration

The configuration options for the Liquid Cooling Package in the group frame **Cooling System** are described in detail in sections 8.2.3 "Changing the measurement units" and 8.2.4 "LCP configuration". All other configuration options are described in the assembly and operating instructions of the CMC III PU 7030.000.

If a subordinate component such as the "Liquid Cooling Package" is selected, the following configuration options are available by clicking on the relevant symbols:

- Configure All Alarms
- Configure Device Rights

These configuration options are described in detail in the assembly and operating instructions of the CMC III PU 7030.000.

9.7 Virtual devices

When a Door Control Module is deployed on the Liquid Cooling Package in conjunction with firmware version $\geq 3.03.00$, after clicking the "Door opening" button, ten buttons from "1" to "0" are displayed. These buttons can be configured individually. When a Door Control Module 7320.790 is deployed, a "virtual device" of type "Access Controller" must be created.

A Door Control Module 7320.790 with a display firmware version $< 3.03.00$ is operated without additional configuration directly with the Door Control 1 to Door Control 4 keys. No virtual device needs to be created. A Door Control Module 7030.500 with a display firmware version $\geq 3.03.00$ is operated with the ten buttons from "1" to "0". This requires that the access authorisations are specified in the Access Configuration (see section 9.7.4 "Access configuration"). A virtual device does **not** need to be created in this case.

9.7.1 Creating a virtual device

- Select the "Virtual Devices" entry in the navigation area of the screen.
- Click the **"Configuration"** tab in the right-hand area of the screen.
- Click the **New** tab in the **List of Virtual Devices** group frame.
- Select the "Access controller" type in the "Virtual Device Type" dropdown list in the "Create new virtual device" dialogue.
- Click the **OK** button to confirm your selection.
Finally, the configuration change causes the list of all devices to be refreshed automatically. The above-mentioned "access controller" marked with a small green "+" character appears as new component under the "Virtual Devices" in the navigation area. The multi-LED of the CMC III PU flashes cyclically green – orange – red.
- Confirm the message for the configuration change (see section 9.2.2 "Acknowledging messages").

The device list is refreshed automatically. The entry under the "Virtual Devices" now has a yellow background and the LED of the CMC III PU lights orange continually provided no other alarm is pending.

9.7.2 Configuring the output

Finally, the output of the Access Controller to be switched must be specified.

- Select the "Access Controller" entry with yellow background in the navigation area of the screen.
- Click the **"Configuration"** tab in the right-hand area of the screen.
- Click the "Inputs and Outputs" symbol (middle symbol at the end of the "Access controller" row).
The "Input/Output Configuration" dialogue opens.
- Select for the output of the virtual device, e.g. the "Door Opening.Manual Front.Input Access.Command" entry for the front door or the "Door Opening.Manual Rear.Input Access.Command" entry for the rear door.

The device list is then refreshed automatically. A blue "information" symbol is displayed in the entry under the "Virtual Devices" and the LED of the CMC III PU lights green continually provided no other alarm is pending.

- Finally, configure all settings on the **Observation** button (see section 9.7.3 "Configuring a virtual device").

9.7.3 Configuring a virtual device

- Select the appropriate "virtual device" in the navigation area of the screen.
- Click the **Observation** tab to make the settings.
The general settings for the virtual device are performed or the parameters that provide detailed information about the virtual device are displayed at the "Device" level (see section 9.5.1 "Device"). The "Production Date" parameter shows the calendar week in which the virtual device was created in the Liquid Cooling Package.
The following parameters for an access controller are displayed at the "Virtual Device" level.

Access Controller

Parameter	Explanation
DescName	Individual description of the virtual device, e.g. "Front Door" or "Rear Door".
Command	The selection of the "Switch" command switches the output of the virtual device. It then switches the status stored in the "AccessLogic" field for the duration stored in the "Delay" field.
OutputValue	The current value of the switchable output assigned to the Access Controller ("On" or "Off").

Tab. 38: "Virtual Device" level for an access controller

Parameter	Explanation
Delay	The duration for which the output of the virtual device changes its status. Once this period has expired, the output switches back to its original status. This parameter has an effect only when the "Toggle Output" entry is not selected in the "Access-Logic" dropdown list.
AccessLogic	The status to which the output of the virtual device toggles for a permitted input. "Delayed On": Activate the output. "Delayed Off": Deactivate the output. "Toggle Output": Toggle the output to the other status (from "On" to "Off" and vice versa).
Status	Current status of the access controller.

Tab. 38: "Virtual Device" level for an access controller

Observe the following sequence for the configuration data of an access controller:

- Select in the "AccessLogic" dropdown list the status to which the access controller should be switched, e.g. "Delayed Off".
- Specify with the "Delay" parameter the duration for which the output should switch to the previously selected status.
- Activate the "Switch" entry in the "Command" dropdown list.

The access controller switches for the entered duration to the previously selected status, e.g. "Off", and then back to the other status, e.g. "On".

Specify in the Access Configuration with which access codes or which transponder cards the access controller can be activated (see section 9.7.4 "Access configuration").

9.7.4 Access configuration

The access authorisations for the door to be monitored are defined on the **Configuration** tab (**Access Configuration** button).

To create an access code:

- First select the "Processing Unit" node in the navigation area.
- Select the **Configuration** tab in the configuration area.
- In the **Security** group frame, click the **Access Configuration** button.
The "Access Configuration" dialogue opens.
- Below the list of access codes / transponder cards that have already been added in the **Access** group frame of the "Access Configuration" dialogue, click the **Add** button.

A new row is added to the end of the table.

To configure an access code:

- Select in the **Access** group frame the line with the required entry to adapt the associated settings.
- Click the **Edit** button.
The "Access Configuration" dialogue opens.

Parameter	Explanation
Type	Configuration of an access. The "Keycode" entry must be selected here.
Code	Number of the button with which the output should be switched. Only one position can be specified, a number code with multiple positions is not supported.
User	Selection of the user authorised for the access. The user must have been created in advance.
Information	Specific additional information for the access. This text is also added for the user in the CMC III Processing Unit logfile.

Tab. 39: Parameters group frame

All connected access modules are displayed in the **Devices** group frame.

Parameter	Explanation
Use	Enable or disable individual access modules.
Device Name	Specific description of the previously created virtual access controller.
Serial Number	Serial number of the virtual access controller.

Tab. 40: Devices group frame



Note:

A user must be assigned to the access code. Otherwise, access is not possible even with the input of the correct access code.

To delete an access code:

- Select the line with the required entry you wish to delete.
- If necessary, select another entry by keeping the shift key pressed. All lines from the first entry selected to the last entry selected (inclusive) are selected.
- If necessary, select further entries by keeping the "Ctrl" key pressed. These lines are added individually to the selection.
- Click the **Delete** button.
All selected access authorisations are immediately deleted without a confirmation prompt.

9.8 Tasks

The status of all connected components may be polled and logically interlinked using Tasks. The meanings of all statuses are described under the setting options for the individual components (see section 9.5 "Observation index tab"). Additionally, date values may also be incorporated into the links. In the event of a status change to the so-called trigger expression, various actions may then be activated. For example, in the event of an alarm message from the integrated access sensor on a certain day of the week, a corresponding e-mail may be sent. The current status of a task cannot be polled via SNMP.

Tasks have general validity. For this reason, the information displayed on the **Tasks** index tab is independent from the components selected in the left-hand section of the screen.

Example: The fans should be switched off when the upper limit temperature of the server inlet temperature for which an alarm message will be output is exceeded.

- Activate the "Enable" checkbox in the **Details** group frame and specify a meaningful name for the task in the **Name** field.
- Select the "=" operator in the **Trigger Expression** group frame.
- Click the "No Variable Selected" entry below the "=" operator.
- Select the "Variable" entry (preselected by default) in the "Nature" dropdown list.
- Select the "[2] Liquid Cooling Package" entry in the "Device" dropdown list.
- Select the "Air.Server-In.Status" entry in the "Variable" dropdown list.
- Set in the trigger expression below the selected "Air.Server-In.Status" variable the associated value for which the fans should be switched off, e.g. "Too High".
- Now select the "Set Variable Value" entry as action in the dropdown list in the **Details** group frame.
- Click the **Setup** button.
The "Configure Set Variable Value" dialogue is displayed.
- Select the "[2] Liquid Cooling Package" entry for the device.
- Select the "Config.Fans.Command" entry in the "Variable" dropdown list.
- Select the "Off" entry in the "Value on True" dropdown list.
- For safety reasons, select the "Automatic" entry in the "Value on False" dropdown list.
This causes the fans to be switched on again when the status of the server inlet temperature no longer has the status "Too High".

If, in addition to shutting down the fans, the control valve in the water circuit should also be closed, a further task for the same condition must be created.

Manual settings e.g. regarding the operating mode of the fans may be overwritten by actions triggered in the event of status changes.

Example: You have defined a task whereby the fans are switched off if the upper server inlet limit temperature is exceeded. To this end, the variable **Config.Fans.Command** is assigned the value **Off** if the **Temperature.Status** has a value of **Too High** ("Value on True"). Furthermore, the variable **Config.Fans.Command** is assigned the value **Automatic** if the **Temperature.Status** does not have a value of **Too High** ("Value on False"). If the server inlet temperature then drops back to within the preset limits after exceeding the upper limit, the fans are **always** switched to automatic mode by the task, regardless of the previously selected fan operating mode (e.g. "Manual", "Off" or "Full").



Note:

Further information on the creation of tasks may be found in the assembly and operating instructions of the CMC III PU 7030.000.

10 Updates and data backup

Because FTP access to the CMC III PU of the Liquid Cooling Package is required only to perform software updates and for data backup, the access should be generally blocked and briefly activated only for the above-mentioned tasks.



Note:

Further information about these topics is available in the assembly and operating instructions of the CMC III PU 7030.000.

Rittal recommends that a data backup of the CMC III PU configuration is made in regular intervals.

The settings and configurations of all connected components as displayed currently for the individual sensors on the **Observation** and **Configuration** tabs are stored in the "cmcllsave.cfg" file (as of software version V3.11.00).

For a second Liquid Cooling Package of the same type, this configuration file can be placed for transfer similarly in the upload directory. This LCP is then configured automatically similarly as the LCP for which this file was saved.



Note:

It is not possible to transfer a configuration file that was stored from a CMC III PU with an older software version to a CMC III PU with a newer software version.

11 Troubleshooting

EN

11 Troubleshooting

11.1 General faults

Malfunction location	Malfunction	Cause of malfunction	Effect	Remedy
Control valve	The CMC III PU displays flow even though the control valve is displayed as closed	The control valve is dirty	The flow meter displays a value. There is a ΔT .	Use the CMC III PU to open and close the control valve several times; contaminants may be loosened. It is highly recommended that a filter be installed in the system to ensure the required water quality. If needed, disconnect power to the complete Liquid Cooling Package and restart after approx. 1 minute.
Flow meter	The CMC III PU displays no flow even though the control valve is displayed as open	Flow meter is dirty	The flow meter displays no value, even though the control valve is open and there is a ΔT .	The flow meter must be removed and cleaned or replaced by authorised personnel. It is highly recommended that a filter be installed in the system to ensure the required water quality.
Electronics/ Software	The electronics/software do not respond	The system is hung up, e.g. through loose connection or incorrect operation	No response, display and control via the CMC III PU do not work correctly.	Disconnect power to the complete Liquid Cooling Package and restart after approx. 1 minute. Also disconnect any existing network connections by removing the control unit network connector from the CMC III PU of the Liquid Cooling Package.
Liquid Cooling Package	The Liquid Cooling Package is not regulating temperature and is operating in emergency mode	The communication between the fan or the water PCB and the CMC III PU is interrupted	The 2-way control valve is open and the fans operate at full speed.	Press the "C" button on the Liquid Cooling Package control unit for approx. 2 seconds. If the communication can be restored, the system then returns to normal operation. If this is not the case, the system restarts. Contact the service department if the fault continues.
	The unit is not providing the required cooling output	Air in the system	If there is air in the system, the water cannot circulate properly in the heat exchanger. Thus, it cannot remove heat.	Bleeding the air from the heat exchanger

Malfunction location	Malfunction	Cause of malfunction	Effect	Remedy
Liquid Cooling Package	The unit is not providing the required cooling output	Increased pressure loss on the piping network side, e.g. through a clogged filter or incorrectly set flow limiter	The external pumps are not able to pump enough cold water through the Liquid Cooling Package.	Clean the filter, set the flow limiter correctly.
		Air routing not correct	The cooled air passes through unsealed openings past the equipment to the back of the enclosure.	Unused height units in the 482.6 mm (19") level as well as side slots and openings must be sealed using blanking plates or foam strips. Both are available as accessories.

In order to prevent malfunctions caused by the cold water system, the following remedies should be implemented.

Malfunction location	Malfunction	Cause of malfunction	Effect	Remedy
Cold water system	Corrosion and contaminants in the cold water system	Insufficient cleaning after a new installation	Unclean and aggressive water leads to a weakening of the material and to improper function. The function of components such as the 2-way control valve and the flow meter is strongly impaired through contaminants.	During initial installation, the pipe network and the system parts should be flushed out before the installation of the Liquid Cooling Package.
		Improper treatment of the water with corrosion protection additives		Rittal GmbH & Co. KG recommends the installation of filters and the treatment of the water with appropriate corrosion and, if needed, antifreeze additives. The recommended notes regarding water quality are found in section 17.2 "Tables and characteristic curves".
		Older systems with existing contaminants		Upon integration in existing cold water networks, the use of a water/water heat exchanger is recommended. This forms a second water circuit.

11 Troubleshooting

EN

11.2 Messages on the display

Message	Cause of malfunction
Rotation error fan X	Speed of fan no. X faulty.
Fail. temp. sensor 1.1	Temperature sensor 1, server inlet temperature top faulty.
Fail. temp. sensor 2.1	Temperature sensor 2, server inlet temperature middle faulty.
Fail. temp. sensor 3.1	Temperature sensor 3, server inlet temperature bottom faulty.
Fail. temp. sensor 1.2	Temperature sensor 1, server outlet temperature top faulty.
Fail. temp. sensor 2.2	Temperature sensor 2, server outlet temperature middle faulty.
Fail. temp. sensor 3.2	Temperature sensor 3, server outlet temperature bottom faulty.
Fail. water sensor X	Water temperature sensor at the inlet (1) or the return (2) faulty.
Water module lost	Water module not present
Fan module lost	Fan module not present
Water leakage	Leak message
Fail. temp. serv-in	Average value of the three server inlet temperature sensors below the set limit value.
Fail. temp. serv-out	Average value of the three server outlet temperature sensors below the set limit value.
Failure motor valve	Control valve faulty
Failure flowmeter	Flow faulty

A configuration change of the LCP or the CMC III PU, such as the connection of an additional sensor or the loss of a water or fan PCB, will be indicated on the multi-LED (see section 9.1.1 "Control unit hardware for the Liquid Cooling Package"). These messages must then be acknowledged appropriately (see section 9.2.2 "Acknowledging messages").

12 Inspection and maintenance

The Liquid Cooling Package is largely maintenance-free. An additional external strainer with fine-mesh sieve is required if the cooling water is contaminated. This should be cleaned regularly.

- The condensate discharge device should be checked regularly for proper function.
- Visually inspect for leaks regularly (annual cycle).



Note:

At an ambient temperature of 40°C, the nominal service life of the built-in fan is 40,000 operating hours.

Fan module malfunctions are displayed on the optional display or on the status screen of the CMC III PU (if the Liquid Cooling Package is connected to a network). Furthermore, the built-in control system compensates fully in the event of a fan module failure.

13 Storage and disposal

EN

13 Storage and disposal



Caution! Risk of damage!

The air/water heat exchanger must not be subjected to temperatures above +70°C during storage.

During storage, the air/water heat exchanger must stand upright.

Disposal can be performed at the Rittal plant.

Please contact us for advice.

Emptying:

During storage and transportation below freezing point, the air/water heat exchanger should be drained completely.

To this end, with the Liquid Cooling Package, the valves in the lowest heat exchanger position should be opened so that the cooling liquid can run out.

14 Technical specifications

14.1 30 kW versions

14.1.1 LCP Rack and LCP Inline

Technical specifications			
Description/Model No.	TopTherm LCP Rack 30 CW / 3311.130 (1000 mm depth)		
Description/Model No.	TopTherm LCP Rack 30 CW / 3311.230 (1200 mm depth)		
Description/Model No.	TopTherm LCP Inline 30 CW / 3311.530 (1200 mm depth)		
Dimensions and weight			
Dimensions width x height x depth (mm)	300 x 2000 x 1000 (3311.130) or 1200 (3311.230/530)		
Usable U	42		
Weight, max. [kg]	220		
Electrical connection			
Type of electrical connection	Connector		
Rated voltage [V, Hz]	208/1~ 50/60	230/1~ 50/60	400/3~/N/PE 50/60
Rated current [A] (1 fan)	2.3	2.0	0.8
Max. current [A] (6 fans)	13.5	12.3	4.1
Pre-fuse [A] (6 fans)	20	20	10
Duty cycle [%]	100		
Protection category	IP 20		
Cooling output (in relation to 24°C server intake air temperature)			
Number of fans	1	2	3
Cooling output [kW]	10	20	30
Rated output P_{el} [kW]	0.47	0.65	1.1
Air throughput, max. [m ³ /h]	4800		
Cooling circuit			
Cooling medium	Water (see Internet for specifications)		
Coolant inlet temperature [°C]	+15		
$P_{O_{H_2O}}$ [bar (psi)]	2 to 6 (29 to 88)		
$P_{S_{H_2O}}$ [bar (psi)]	6 (88)		
$P_{T_{H_2O}}$ [bar (psi)]	12 (175)		
Fill volume including water module [l]	8		
Water connection	DN 40 (1½" external thread on the device)		

Tab. 41: Technical specifications for 30 kW versions

14 Technical specifications

EN

Technical specifications	
Other information	
Temperature control	Linear fan control/2-way control valve
TO _{Air} [°C (°F)]	+6 to +35 (+43 to +95)
TS _{Air} [°C (°F)]	+6 to +35 (+43 to +95)
Noise level [dB(A)] (Open air above reflective flooring, distance 1 m)	77 (3 fan modules, 5000 m ³ /h) 69 (6 fan modules, 5000 m ³ /h)
Colour	RAL 7035

Tab. 41: Technical specifications for 30 kW versions

14.1.2 LCP Inline flush

Technical specifications			
Description/Model No.	TopTherm LCP Inline flush / 3311.540		
Dimensions and weight			
Dimensions width x height x depth (mm)	300 x 2000 x 1200		
Usable U	42		
Weight, max. [kg]	220		
Electrical connection			
Type of electrical connection	Connector		
Rated voltage [V, Hz]	208/1~ 50/60	230/1~ 50/60	400/3~/N/PE 50/60
Rated current [A] (2 fans)	4.3	3.9	1.3
Max. current [A] (4 fans)	9.6	8.1	2.7
Pre-fuse [A] (4 fans)	16	16	10
Duty cycle [%]	100		
Cooling output (in relation to 24°C server intake air temperature)			
Number of fans	2	3	4
Cooling output [kW]	18	27	30
Rated output P _{el} [kW]	Max. 1.8 at 100% fan speed		
Air throughput, max. [m ³ /h]	4800		
Protection category	IP 20		
Cooling circuit			
Cooling medium	Water (see Internet for specifications)		
Coolant inlet temperature [°C]	+15		
PO _{H2O} [bar (psi)]	2 to 6 (29 to 88)		
PS _{H2O} [bar (psi)]	6 (88)		
PT _{H2O} [bar (psi)]	12 (175)		
Fill volume including water module [l]	8		

Tab. 42: Technical specifications for LCP Inline flush

Technical specifications	
Water connection	DN 40 (1½" external thread on the device)
Other information	
Temperature control	Linear fan control/2-way control valve
TO _{Air} [°C (°F)]	+6 to +35 (+43 to +95)
TS _{Air} [°C (°F)]	+6 to +35 (+43 to +95)
Noise level [dB(A)] (Open air above reflective flooring, distance 1 m)	84 (4 fan modules, 5300 m ³ /h) 71 (4 fan modules, 3000 m ³ /h, partial load operation)
Colour	RAL 7035, front door RAL 7035 (struts) and 9005 (perforated panel)

Tab. 42: Technical specifications for LCP Inline flush

14.2 55 kW versions

Technical specifications			
Description/Model No.	TopTherm LCP Rack 55 CW / 3311.260		
Description/Model No.	TopTherm LCP Inline 55 CW / 3311.560		
Dimensions and weight			
Dimensions width x height x depth (mm)	300 x 2000 x 1200		
Usable U	42		
Weight, max. [kg]	240		
Electrical connection			
Type of electrical connection	Connector		
Rated voltage [V, Hz]	208/1~ 50/60	230/1~ 50/60	400/3~/N/PE 50/60
Rated current [A] (4 fans)	9	8.1	2.7
Max. current [A] (6 fans)	13.5	12.3	4.1
Pre-fuse [A] (6 fans)	20	20	10
Duty cycle [%]	100		
Protection category	IP 20		
Cooling output (in relation to 24°C server intake air temperature)			
Number of fans	4	5	6
Cooling output [kW]	40	50	60
Rated output P _{el} [kW]	1.87	2.2	2.8
Air throughput, max. [m ³ /h]	8000		
Cooling circuit			
Cooling medium	Water (see Internet for specifications)		
Coolant inlet temperature [°C]	+15		
PO _{H2O} [bar (psi)]	2 to 6 (29 to 88)		
PS _{H2O} [bar (psi)]	6 (88)		

Tab. 43: Technical specifications for 55 kW versions

14 Technical specifications

EN

Technical specifications	
PT _{H2O} [bar (psi)]	12 (175)
Fill volume including water module [l]	8
Water connection	DN 40 (1½" external thread on the device)
Other information	
Temperature control	Linear fan control/2-way control valve
TO _{Air} [°C (°F)]	+6 to +35 (+43 to +95)
TS _{Air} [°C (°F)]	+6 to +35 (+43 to +95)
Noise level [dB(A)] (Open air above reflective flooring, distance 1 m)	79 (6 fan modules, 8000 m ³ /h) 69 (6 fan modules, 6000 m ³ /h, partial load operation)
Colour	RAL 7035

Tab. 43: Technical specifications for 55 kW versions

15 Spare parts

Item	Qty./Pack
Control unit	1
Water PCB	1
Fan PCB	1
Startup current limitation	1
Fan, single	1
Leakage sensor	1
Control valve	1
Flow meter 5-100	1
Flow meter 10-200	1
Temperature sensor, hot/cold air	1
Temperature sensor, water inlet	1
Temperature sensor, water return	1
Fuse box with breaker, EMC filter and power pack	1

Tab. 44: Spare parts list – Liquid Cooling Package

16 Accessories

EN

16 Accessories

Item	Model No.	Qty./Pack	Comments
Vertical shielding (foam strips) for enclosure width 600 mm, for mounting side panel	3301.380	1	
Vertical shielding (foam strips) for enclosure width 600 mm, for mounting Liquid Cooling Package	3301.370	1	
Vertical shielding (foam strips) for enclosure width 800 mm, for mounting side panel	3301.390	1	
Vertical shielding (foam strips) for enclosure width 800 mm, for mounting Liquid Cooling Package	3301.320	1	
Air baffle plate for TS, for enclosure width 600 mm	7151.206	2	
Air baffle plate for TS, for enclosure width 800 mm	7151.208	2	
Add-on cover	3301.221	1	
Connection hose bottom/top	3311.040	2	Length 1.8 m, may be shortened
Connection cable, three-phase	7856.025	1	EU-type
Touch panel display, colour	3311.030	1	
Fan module for 3311.130/230/260 and 3311.530/560	3311.010	1	For LCP Rack and LCP Inline with serial number smaller than 300,000.
Fan module for 3311.540	3311.011	1	For LCP Rack and LCP Inline with serial number larger than 300,000.
Rear adaptor for LCP Inline	3311.080	1	
Server enclosure compensating panel for LCP Inline	7067.200	1	

Tab. 45: Accessories list – Liquid Cooling Package

In addition to the integrated sensors, the CAN bus interface allows a wide range of sensors, actuators and systems for access monitoring to be connected. A detailed listing of the complete range of accessories can be found at the Internet address specified in section 21 "Customer service addresses".

17 Further technical information

17.1 Hydrological information

To avoid damages to the system and ensure reliable operation, the provisions of VDI 2035 should be observed for filling and top-up water.

Admissible cooling media

- Saline and low-salinity water based on VDI 2035 plus max. 50 volume percent Antifrogen-N (see table 46).

Recommended cooling medium

- Low-salinity water (demineralised water) based on VDI 2035. Up to a maximum of 50 volume percent Antifrogen-N may be added (see table 46).

	Low-salinity	Saline
Electrical conductivity at 25°C [$\mu\text{S}/\text{cm}$]	< 100	100...1,500
Appearance	Free from sedimenting substances	
pH value at 25°C	8.2...10.0	
Oxygen [mg/l]	< 0.1	< 0.02

Tab. 46: Water specifications

17 Further technical information

EN

17.2 Tables and characteristic curves

17.2.1 Cooling output, 30 kW versions

The information given in the following tables applies to a volumetric airflow of 5,000 m³/h, where the cooling medium used is water without glycol.

Control by the Liquid Cooling Packages is based on the server intake air. Depending on the load to be dissipated, the water return temperature given in the tables may fluctuate accordingly.

	LCP Type 3311.130, 3311.230, 3311.530, 3311.540			
No. of fan modules	4	4	4	4
Water inlet [°C]	6	6	6	6
Water return [°C]	12.3	13.1	14	14.8
Water volume [l/min]	60	60	60	60
Server exhaust air, relative humidity	30°C, 20%	33°C, 17%	36°C, 14%	39°C, 12%
Server intake air, relative humidity	14°C, 54%	15°C, 52%	16°C, 49%	17°C, 45%
Cooling output, total [kW]	21.5	24.9	28.3	31.7
Cooling output, sensitive [kW]	21.5	24.9	28.3	31.7

Tab. 47: Cooling output with a water inlet temperature of 6°C

	LCP Typ 3311.130, 3311.230, 3311.530, 3311.540				
No. of fan modules	4	4	4	4	4
Water inlet [°C]	9	9	9	9	9
Water return [°C]	14.6	15.5	16.3	17.1	18
Water volume [l/min]	60	60	60	60	60
Server exhaust air, relative humidity	30°C, 25%	33°C, 21%	36°C, 18%	39°C, 15%	42°C, 13%
Server intake air, relative humidity	16°C, 61%	17°C, 57%	18°C, 54%	19°C, 50%	20°C, 47%
Cooling output, total [kW]	18.5	22	25.5	28.9	32.4
Cooling output, sensitive [kW]	18.5	22	25.5	28.9	32.4

Tab. 48: Cooling output with a water inlet temperature of 9°C

17 Further technical information

EN

	LCP Typ 3311.130, 3311.230, 3311.530, 3311.540				
No. of fan modules	4	4	4	4	4
Water inlet [°C]	12	12	12	12	12
Water return [°C]	17	17.7	18.6	19.4	20.2
Water volume [l/min]	60	60	60	60	60
Server exhaust air, relative humidity	30°C, 44%	33°C, 39%	36°C, 36%	39°C, 31%	42°C, 27%
Server intake air, relative humidity	18°C, 76%	19°C, 71%	20°C, 70%	21°C, 66%	22°C, 60%
Cooling output, total [kW]	15.4	18.9	22.5	26	30
Cooling output, sensitive [kW]	15.4	18.9	22.5	26	30

Tab. 49: Cooling output with a water inlet temperature of 12°C

	LCP Typ 3311.130, 3311.230, 3311.530, 3311.540					
No. of fan modules	4	4	4	4	4	4
Water inlet [°C]	15	15	15	15	15	15
Water return [°C]	19	20	20.8	21.6	22.4	23
Water volume [l/min]	60	60	60	60	60	60
Server exhaust air, relative humidity	30°C, 49%	33°C, 44%	36°C, 40%	39°C, 34%	42°C, 32%	44°C, 28%
Server intake air, relative humidity	20°C, 75%	21°C, 72%	22°C, 70%	22.5°C, 68%	23°C, 66%	24°C, 62%
Cooling output, total [kW]	12.2	15.7	19.2	22.7	26.2	30
Cooling output, sensitive [kW]	12.2	15.7	19.2	22.7	26.2	30

Tab. 50: Cooling output with a water inlet temperature of 15°C

	LCP Typ 3311.130, 3311.230, 3311.530, 3311.540					
No. of fan modules	4	4	4	4	4	4
Water inlet [°C]	18	18	18	18	18	18
Water return [°C]	21.3	22.1	23	23.8	24.6	25.2
Water volume [l/min]	60	60	60	60	60	60
Server exhaust air, relative humidity	30°C, 56%	33°C, 49%	36°C, 45%	39°C, 39%	42°C, 37%	44°C, 32%
Server intake air, relative humidity	22°C, 75%	23°C, 74%	24°C, 73%	24.5°C, 73%	25.5°C, 63%	26°C, 63%
Cooling output, total [kW]	8.8	12.3	15.8	19.3	22.8	25.1
Cooling output, sensitive [kW]	8.8	12.3	15.8	19.3	22.8	25.1

Tab. 51: Cooling output with a water inlet temperature of 18°C

17 Further technical information

EN

17.2.2 Cooling output, 55 kW versions

The information given in the following tables applies to a volumetric airflow of 8,000 m³/h, where the cooling medium used is water without glycol.

Control by the Liquid Cooling Packages is based on the server intake air. Depending on the load to be dissipated, the water return temperature given in the tables may fluctuate accordingly.

	LCP Type 3311.260, 3311.560					
No. of fan modules	6	6	6	6	6	6
Water inlet [°C]	6	6	6	6	6	6
Water return [°C]	10.8	11.4	12	12.7	13.3	13.3
Water volume [l/min]	130	130	130	130	130	130
Server exhaust air, relative humidity	30°C, 20%	33°C, 17%	36°C, 14%	39°C, 12%	42°C, 10%	42°C, 10%
Server intake air, relative humidity	15°C, 51%	16°C, 49%	17°C, 45%	18°C, 43%	19°C, 40%	19°C, 40%
Cooling output, total [kW]	31.7	36.9	42.2	47.5	55	55
Cooling output, sensitive [kW]	31.7	36.9	42.2	47.5	55	55

Tab. 52: Cooling output with a water inlet temperature of 6°C

	LCP Type 3311.260, 3311.560					
No. of fan modules	6	6	6	6	6	6
Water inlet [°C]	9	9	9	9	9	9
Water return [°C]	13.5	14	14.6	15.3	16	16.3
Water volume [l/min]	130	130	130	130	130	130
Server exhaust air, relative humidity	30°C, 25%	33°C, 21%	36°C, 18%	39°C, 15%	42°C, 13%	44°C, 11%
Server intake air, relative humidity	16.5°C, 56%	17.5°C, 53%	18.5°C, 48%	19.5°C, 46%	20.5°C, 43%	21°C, 43%
Cooling output, total [kW]	27.8	33.1	38.5	44	50	55
Cooling output, sensitive [kW]	27.8	33.1	38.5	44	50	55

Tab. 53: Cooling output with a water inlet temperature of 9°C

	LCP Type 3311.260, 3311.560					
No. of fan modules	6	6	6	6	6	6
Water inlet [°C]	12	12	12	12	12	12
Water return [°C]	15.8	16.5	17.1	17.8	18.5	18.4
Water volume [l/min]	130	130	130	130	130	140
Server exhaust air, relative humidity	30°C, 44%	33°C, 39%	36°C, 36%	39°C, 31%	42°C, 27%	44°C, 24%
Server intake air, relative humidity	18°C, 64%	19°C, 60%	20°C, 57%	21°C, 52%	22°C, 49%	22°C, 49%
Cooling output, total [kW]	23.4	28.9	34.4	40	45.5	55
Cooling output, sensitive [kW]	23.4	28.9	34.4	40	45.5	55

Tab. 54: Cooling output with a water inlet temperature of 12°C

	LCP Type 3311.260, 3311.560					
No. of fan modules	6	6	6	6	6	6
Water inlet [°C]	15	15	15	15	15	15
Water return [°C]	18	18.5	19.1	19.7	20.3	21
Water volume [l/min]	140	140	140	140	140	140
Server exhaust air, relative humidity	30°C, 49%	33°C, 44%	36°C, 40%	39°C, 34%	42°C, 32%	45°C, 28%
Server intake air, relative humidity	19.5°C, 67%	20.5°C, 64%	21°C, 64%	22°C, 61%	23°C, 56%	23.5°C, 52%
Cooling output, total [kW]	20	25.7	31.5	38	44	53
Cooling output, sensitive [kW]	20	25.7	31.5	38	44	53

Tab. 55: Cooling output with a water inlet temperature of 15°C

17.2.3 Pressure loss

When using a water/glycol mixture (67% water, 33% glycol), the pressure loss shown in the following diagrams must be multiplied by a factor of 1.2, and the volumetric flow by a factor of 1.5. The glycol portion of the mixture must not exceed 33% maximum.

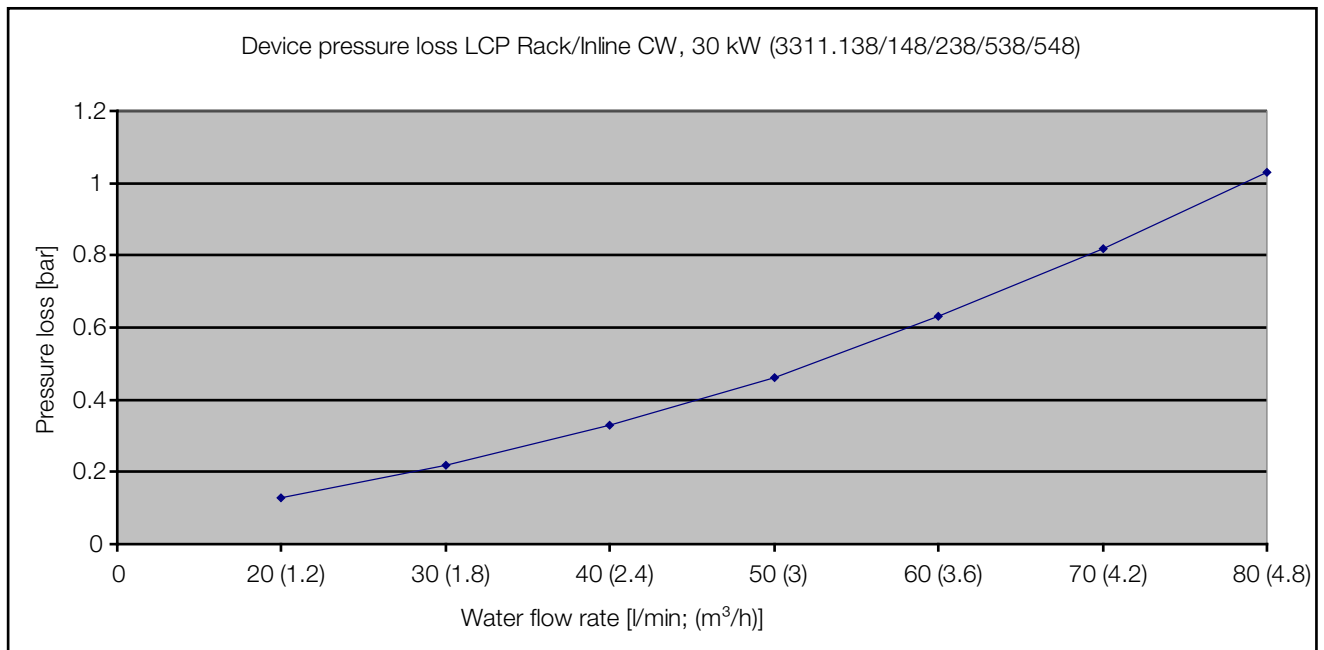

Fig. 85: Pressure loss of the Liquid Cooling Package in the "30 kW" version

17 Further technical information

EN

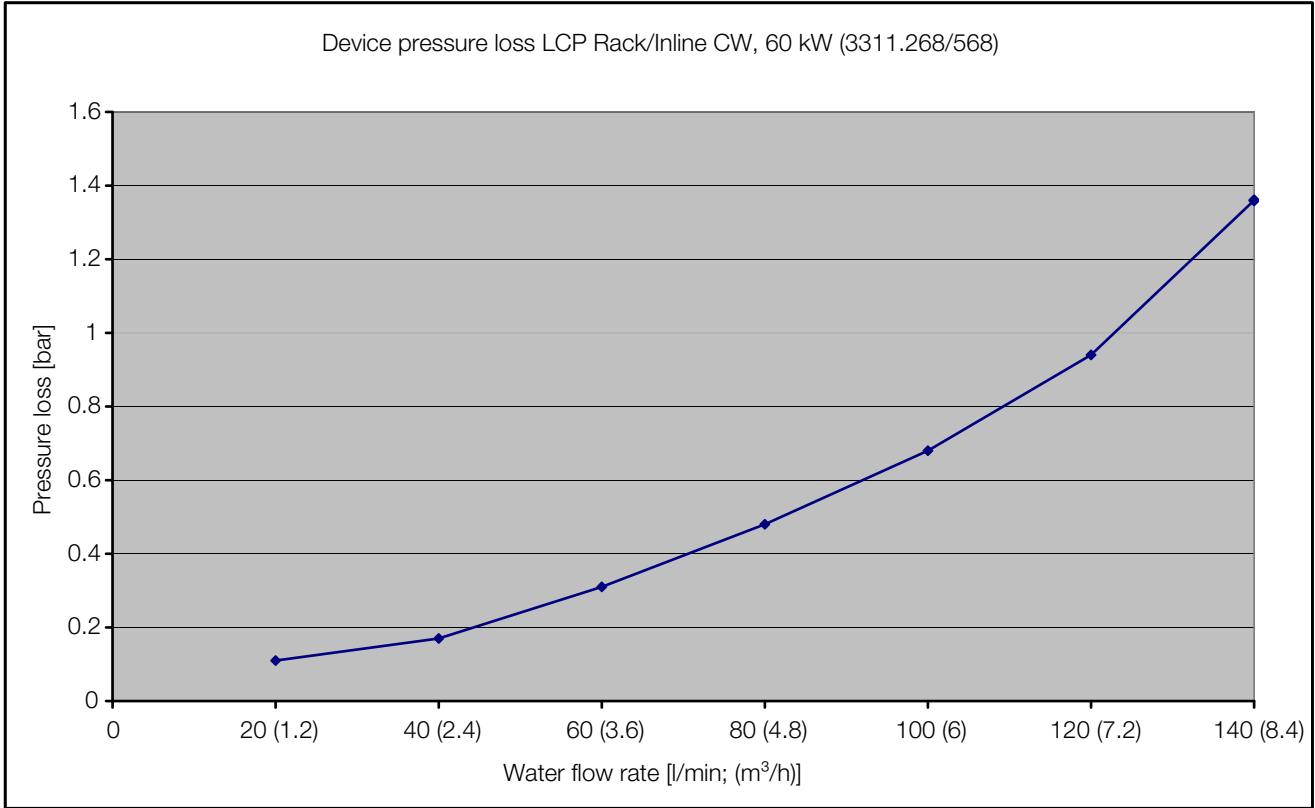

Fig. 86: Pressure loss of the LCP Rack/Inline in the "55 kW" version

17.3 Overview drawings

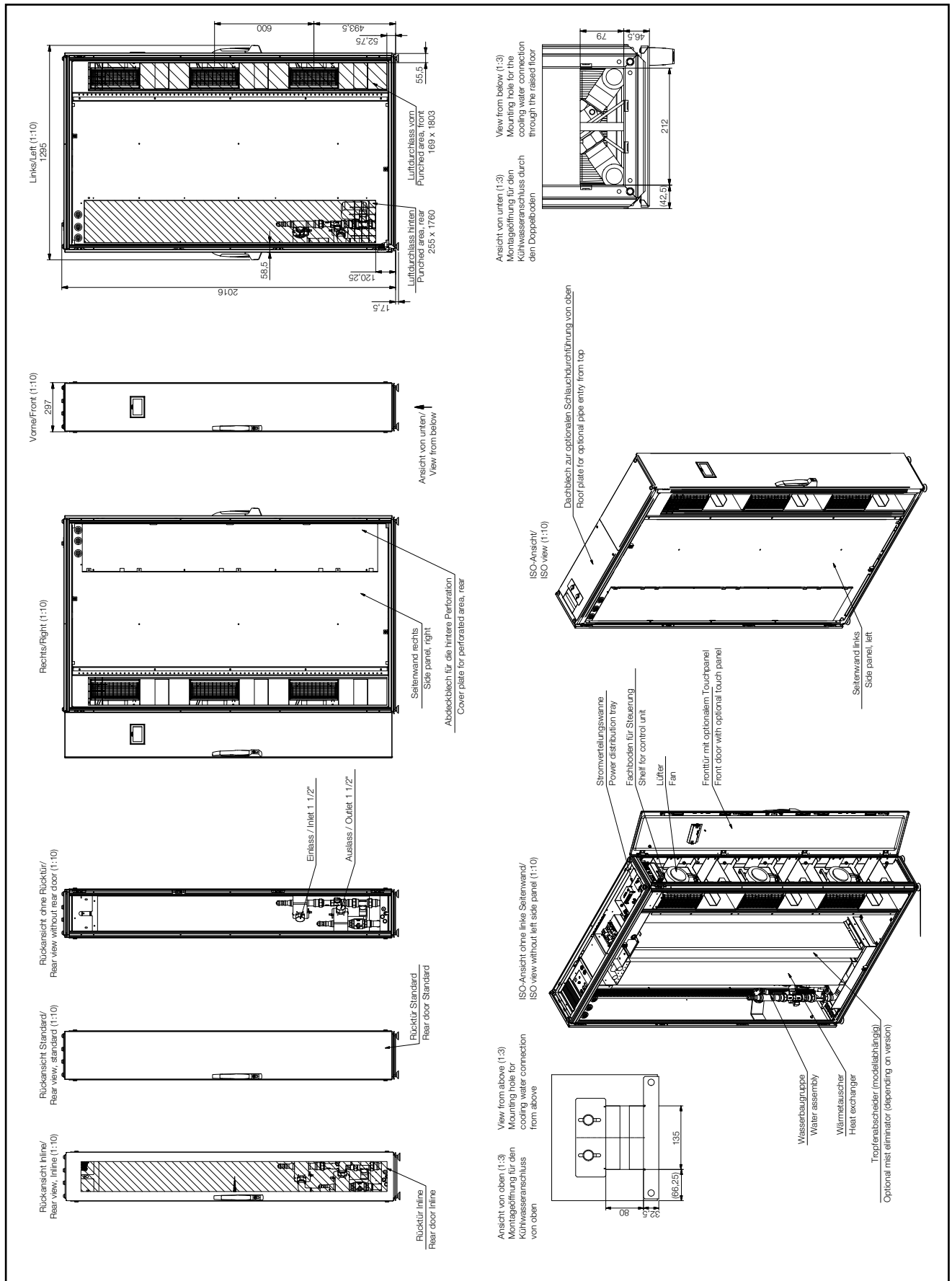

Fig. 87: Overview drawings of LCP Rack/Inline

17 Further technical information

EN

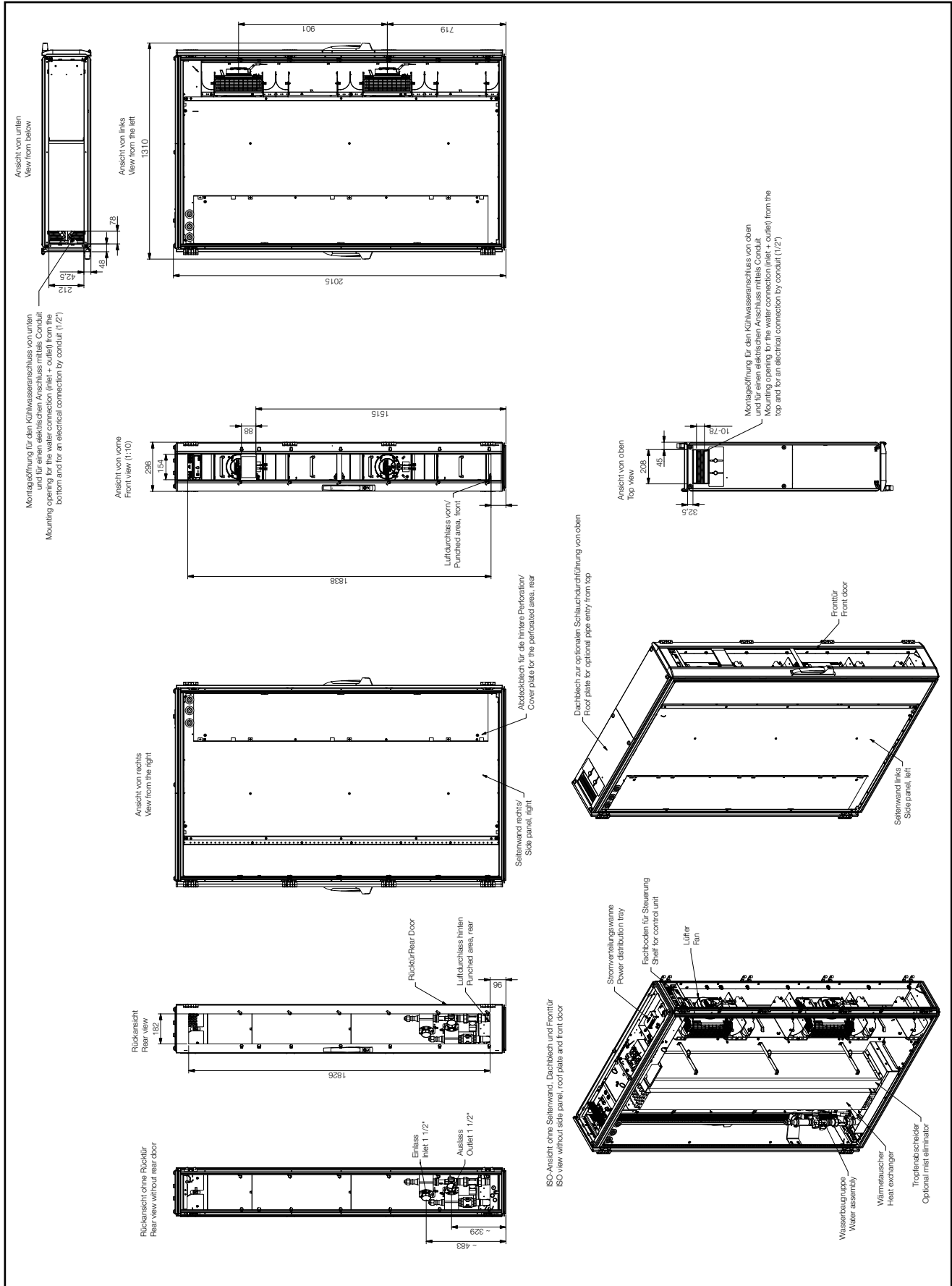

Fig. 88: Overview drawing of LCP Inline flush

17.4 Circuit diagram

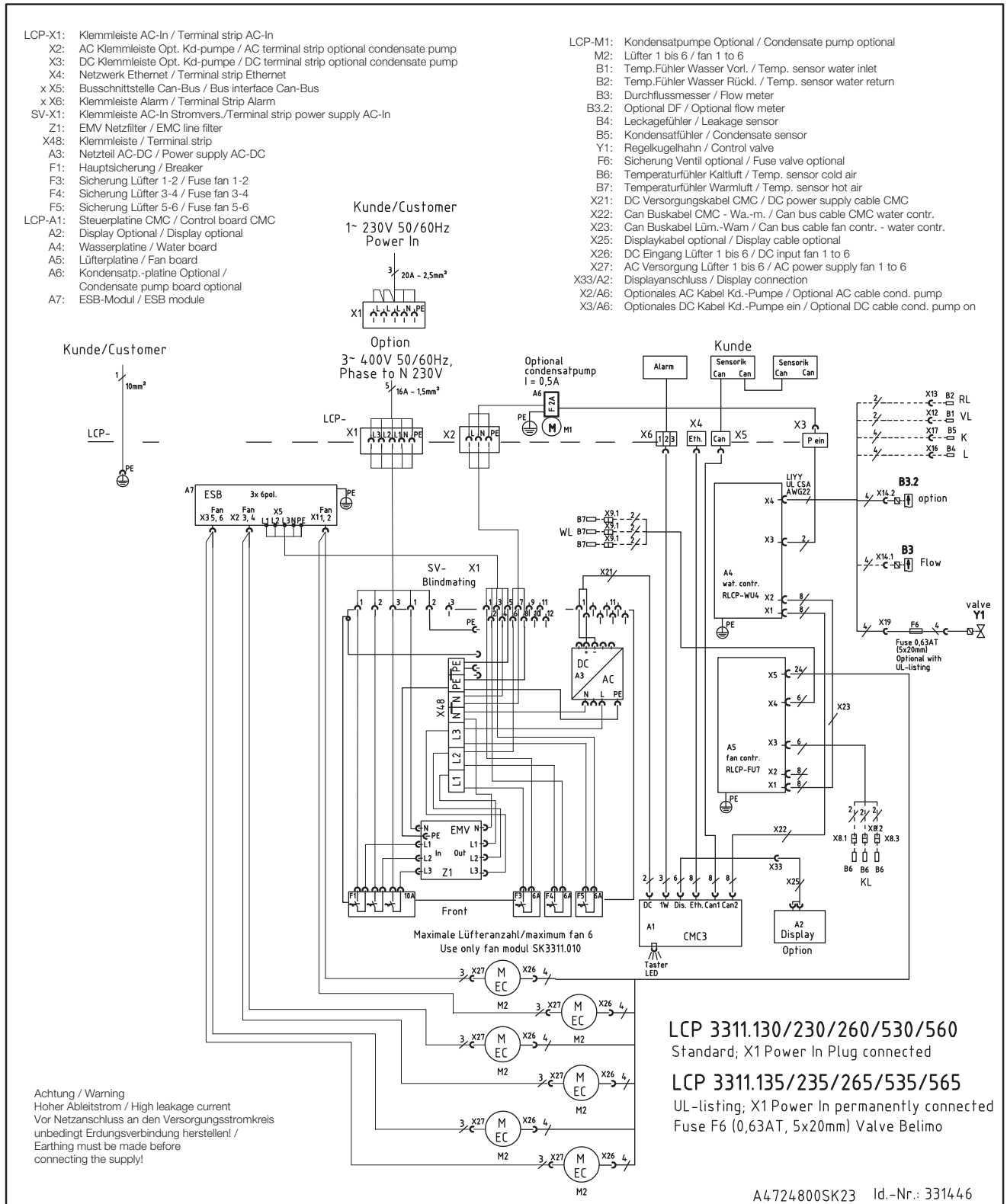

Fig. 89: Circuit diagram of LCP Rack/Inline

17 Further technical information

EN

- LCP-X1: Klemmleiste AC-In / Terminal strip AC-In
- X2: AC Klemmleiste Opt. Kd-pumpe / AC terminal strip optional condensate pump
- X3: DC Klemmleiste Opt. Kd-pumpe / DC terminal strip optional condensate pump
- X4: Netzwerk Ethernet / Terminal strip Ethernet
- x X5: Busschnittstelle Can-Bus / Terminal strip Can-Bus x
- x X6: Klemmleiste Alarm / Terminal strip Ethernet x
- SV-X1: Klemmleiste Blindmating/Terminal blindmating
- Z1: EMV Netzfilter / EMC line filter
- X48: Klemmleiste / Terminal strip
- A3: Netzteil AC-DC / Power supply AC-DC
- F1: Hauptsicherung / Breaker
- F3: Sicherung Lüfter 1-2 / Fuse fan 1-2
- F4: Sicherung Lüfter 3-4 / Fuse fan 3-4
- F5: Sicherung Lüfter 5-6 / Fuse fan 5-6
- LCP-A1: Steuerplatine CMC / Control board CMC
- A2: Display Optional / Display optional
- A4: Wasserplatine / Water board
- A5: Lüfterplatine / Fan board
- A6: Kondensatp.-platine Optional / Condensate pump board optional
- A7: ESB-Modul / ESB module
- LCP-M1: Kondensatpumpe Optional / Condensate pump optional
- M2: Lüfter 1, 2, 3, 4 / fan 1, 2, 3, 4
- B1: Temp.Fühler Wasser Vorl. / Temp. sensor water inlet
- B2: Temp.Fühler Wasser Rückl. / Temp. sensor water return
- B3: Durchflussmesser / Flow meter
- B3.2: Optional DF / Optional flow meter
- B4: Leckagefühler / Leakage sensor
- B5: Kondensatfühler / Condensate sensor
- Y1: Regelkugelhahn / Control valve
- B6: Temperaturfühler Lüfter 1-6 / Temp. sensor fan 1-6
- B7: Temperaturfühler Hex1-6 / Temp. sensor hex 1-6
- X21: DC Versorgungskabel CMC / DC power supply cable CMC
- X22: Can Buskabel CMC - Wa.-m. / Can bus cable CMC - wat contr.
- X23: Can Buskabel Lümm.-Warn. / Can bus cable fan contr. - water contr.
- X25: Displaykabel optional / Display cable optional
- X26: DC Eingang Lüfter 1 bis 6 / DC input fan 1 to 6
- X27: AC Versorgung Lüfter 1 bis 6 / AC power supply fan 1 to 6
- X3/A2: Displayanschluss / Display connection
- X2/A6: Optionales AC Kabel Kd.-Pumpe / Optional AC cable cond. pump
- X3/A6: Optionales DC Kabel Kd.-Pumpe ein / Optional DC cable cond. pump on

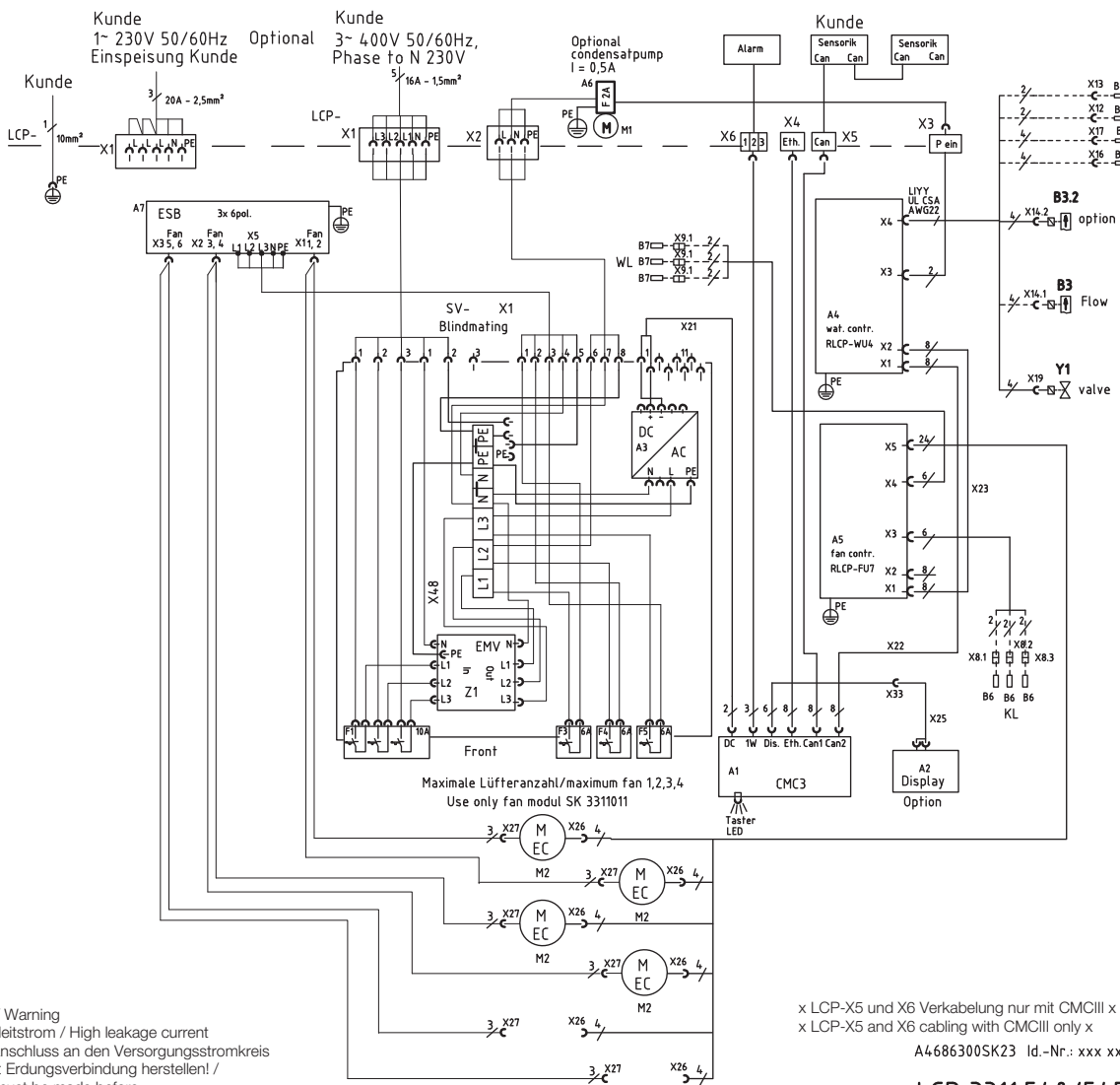

Fig. 90: Circuit diagram of LCP Inline flush

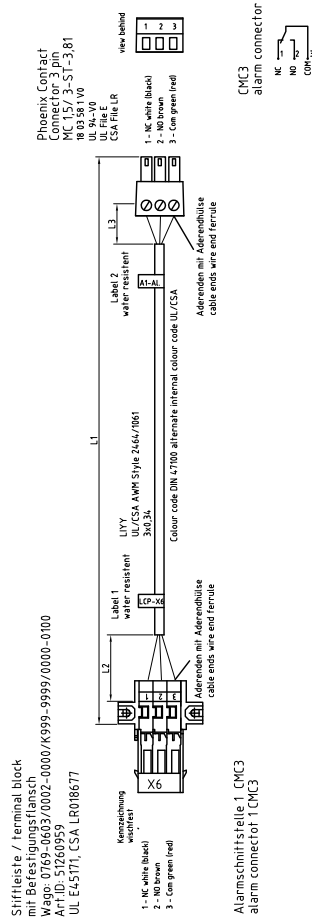

Fig. 91: Pin assignment of X6 terminal strip

17.4.1 Control unit hardware for the fan modules (RLCP fan)

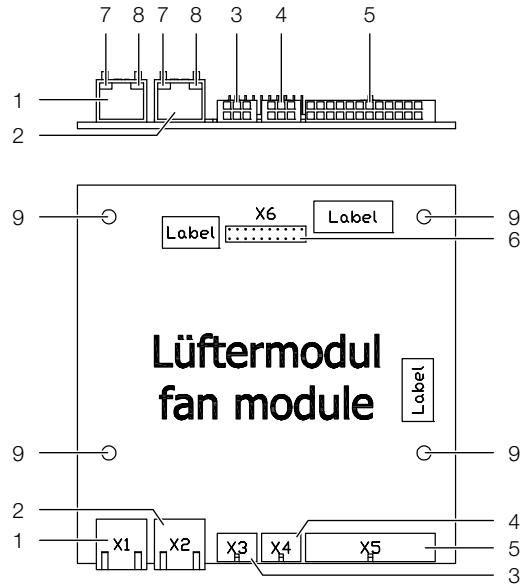

Fig. 92: Control unit fan module – rear/top view

Key

- 1 Control Interface socket (X1) – RJ45
- 2 Control Interface socket (X2) – RJ45
- 3 Temperature sensors, cold air socket (X3) – 6-pole
- 4 Temperature sensors, hot air socket (X4) – 6-pole
- 5 Fan setpoint sockets (X5) – 24-pole
- 6 Debugger
- 7 LED yellow (2x)
- 8 LED green (2x)
- 9 Earth (4x)

X1 / X2 pin assignment:

- 1 CAN 1/2 high
- 2 CAN 1/2 low
- 3 +24 V
- 4 GND
- 5 GND
- 6 +24 V

17 Further technical information

EN

X5 pin assignment:

- 1 SET_1 setpoint fan 1
- 2 10 V from fan 1
- 3 SET_2 setpoint fan 2
- 4 10 V from fan 2
- 5 SET_3 setpoint fan 3
- 6 10 V from fan 3
- 7 SET_4 setpoint fan 4
- 8 10 V from fan 4
- 9 SET_5 setpoint fan 5
- 10 10 V from fan 5
- 11 SET_6 setpoint fan 6
- 12 10 V from fan 6
- 13 SPD_1 actual value, fan 1
- 14 GND fan 1
- 15 SPD_1 actual value, fan 2
- 16 GND fan 2
- 17 SPD_3 actual value, fan 3
- 18 GND fan 3
- 19 SPD_4 actual value, fan 4
- 20 GND fan 4
- 21 SPD_5 actual value, fan 5
- 22 GND fan 5
- 23 SPD_6 actual value, fan 6
- 24 GND fan 6

X3 pin assignment:

- 1 GND temperature sensor 1 cold air
- 2 GND temperature sensor 2 cold air
- 3 GND temperature sensor 3 cold air
- 4 Temperature sensor 1 cold air
- 5 Temperature sensor 2 cold air
- 6 Temperature sensor 3 cold air

X4 pin assignment:

- 1 GND temperature sensor 1 hot air
- 2 GND temperature sensor 2 hot air
- 3 GND temperature sensor 3 hot air
- 4 Temperature sensor 1 hot air
- 5 Temperature sensor 2 hot air
- 6 Temperature sensor 3 hot air

17.4.2 Control unit hardware for the water module (RLCP water)

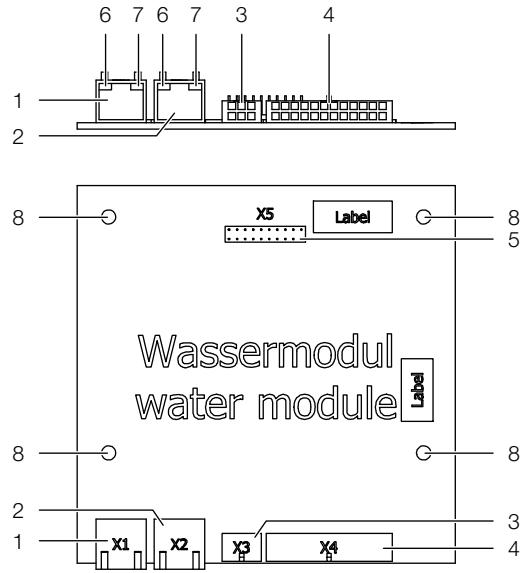

Fig. 93: Control unit water module – rear/top view

Key

- 1 Control Interface socket (X1) – RJ45
- 2 Control Interface socket (X2) – RJ45
- 3 Condensate pump controller socket – 6-pole
- 4 Sensors and actuators socket – 24-pole
- 5 Debugger
- 6 LED yellow (2x)
- 7 LED green (2x)
- 8 Earth (4x)

X1 / X2 pin assignment:

- 1 CAN 1/2 high
- 2 CAN 1/2 low
- 3 +24 V
- 4 GND
- 5 GND
- 6 +24 V

X3 pin assignment:

- 1 GND
- 2 GND
- 3 GND
- 4 +24V
- 5 Condensate pump output
- 6 Addressing input I²C

X4 pin assignment:

- 1 Temperature sensor, water inlet
- 2 Temperature sensor, water return
- 3 GND flow sensor
- 4 TxD flow sensor
- 5 GND optional flow meter
- 6 Output from flow meter
- 7 GND leakage sensor
- 8 +5 V leakage sensor
- 9 GND condensate sensor
- 10 +5 V condensate sensor
- 11 GND control valve
- 12 Input 0-10 V control valve
- 13 Temperature sensor, water inlet
- 14 Temperature sensor, water return
- 15 RxD flow sensor
- 16 +5 V flow sensor
- 17 Output from flow meter
- 18 +24 V flow meter
- 19 Heating function, leakage sensor
- 20 Optosensor, leakage sensor
- 21 Heating function, condensate sensor
- 22 Optosensor, condensate sensor
- 23 Output 0-10 V control valve
- 24 +24 V supply, control valve

Startup current limitation is achieved via delayed activation of the fans when the power returns.



Note:

Fan positions 2 and 5 are not present in the LCP Inline flush.

Assignment of X1 / X2 / X3:

- 1 PE Fan
- 2 PE
- 3 PE
- 4 PE Fan
- 5 Neutral conductor fan
- 6 Phase fan
- 7 Neutral conductor fan
- 8 Phase fan

17.4.3 Hardware for startup current limitation

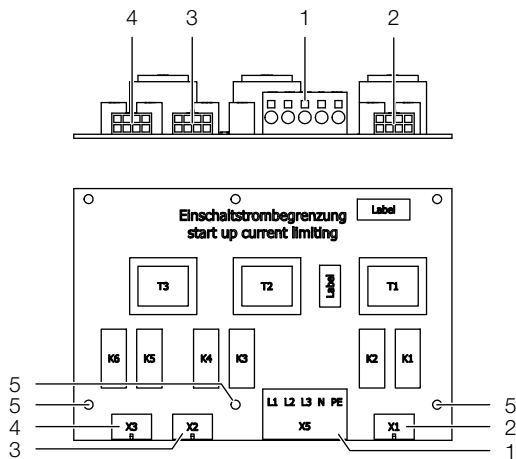

Fig. 94: Startup current limitation – rear/top view

Key

- 1 Terminals for infeed AC (X5) – 5-pole
- 2 Socket for fan 1, 2 (X1) – 8-pole
- 3 Socket for fan 3, 4 (X2) – 8-pole
- 4 Socket for fan 5, 6 (X3) – 8-pole
- 5 Earthing (3x)

X5 pin assignment:

- 1 Phase conductor L1 (1~ L1)
- 2 Phase conductor L2 (1~ L1')
- 3 Phase conductor L3 (1~ L1'')
- 4 Neutral conductor N
- 5 PE conductor

The fans are supplied with voltage in pairs via sockets X1 (fans 1 and 2), X2 (fans 3 and 4) and X3 (fans 5 and 6).

17.5 Water circulation diagram

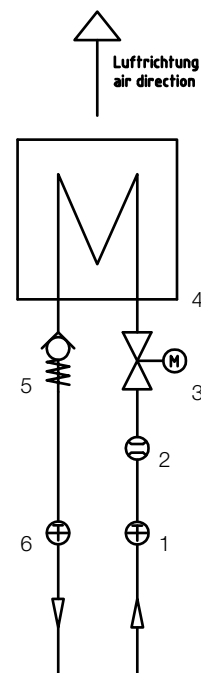

Fig. 95: Water circulation diagram

Key

- 1 Temperature sensor, inlet
- 2 Flow sensor, inlet
- 3 Control valve, inlet
- 4 Heat exchanger
- 5 Non-return valve, return
- 6 Temperature sensor, return

18 Preparation and maintenance of the cooling medium

EN

18 Preparation and maintenance of the cooling medium

Depending on the type of installation to be cooled, certain purity requirements are placed on the cooling water in a recooling system. According to the level of contamination and the size and design of the recooling systems, a suitable process is used to prepare and/or maintain the water. The most common types of contamination and frequently used techniques to eliminate them in industrial cooling are:

Type of impurity	Procedure
Mechanical contamination	Filter the water using: Mesh filter, sand filter, cartridge filter, precoated filter, magnetic filter
Excessive hardness	Soften the water via ion exchange
Moderate content of mechanical contaminants and hardeners	Treat the water with stabilisers and/or dispersing agents
Moderate content of chemical contaminants	Treat the water with passivators and/or inhibitors
Biological contaminants, slime bacteria and algae	Treat the water with biocides

Tab. 56: Cooling water contaminants and treatment procedures



Note:

For the proper operation of a recooling system that uses water on at least one side, the composition of any additive used or system water should not deviate substantially from hydrological data presented in section 17.2 "Tables and characteristic curves".

19 Frequently Asked Questions (FAQ)

Where can general information about LCPs be found?

Operating manuals, technical specifications and drawings can be found at www.rittal.com

In which output ranges is the Rittal Liquid Cooling Package (LCP) available?

The cooling output of an air/water heat exchanger is basically dependent on the inlet temperature and volumetric flow of the water as well as the air throughput achieved by the fans which are used. There are two performance classes:

Up to 30 kW cooling capacity with the device types 3311.130/230/530/540 (for 15°C water inlet, 20 K air-side ΔT , 5000 m³/h air throughput)

Up to 55 kW cooling capacity with the device types 3311.260/560 (for 15°C water inlet, 20 K air-side ΔT , 8000 m³/h air throughput)

To correctly assess the information, it is important to note at what ΔT (temperature differential between server air inlet and server air outlet) these values were reported. Modern servers such as 1 U dual CPU systems or blade servers can have a ΔT of up to 25°C.

Please note the recommendations of the server manufacturer.

Are special components required for use with the Liquid Cooling Package?

All components that follow the "front to back" cooling principle may be used without restriction together with the Liquid Cooling Package.

The use of IT equipment with side air routing can be implemented using special air routing systems.

Every Rittal server rack that was previously cooled conventionally can be cooled with a Liquid Cooling Package (rack cooling) after changing to sealed doors. In other words, it is possible to retrofit standard racks and bay them onto the Liquid Cooling Package.

Racks with perforated doors can be cooled with LCP Inline systems (series cooling).

The server enclosure remains unaffected by the side installation of the Liquid Cooling Package. This means all height units remain fully usable in their complete depth. Further, by locating the separation elements appropriately, sufficient cooling is also possible for devices that require sideways air throughput (e.g. switches).

Which LCP variants are available?

For very large heat losses, the use of direct rack cooling with LCP is recommended.

In this case, the server rack is equipped with solid front and rear doors. The "LCP Rack CW" 3311.130/230/260 variant is ideal for this form of cooling.

The series cooling with LCP is deployed for low to mid-range heat losses.

In this case, server racks with perforated front and rear doors are normally placed in a row (cold aisle / hot aisle) with the LCPs installed in between.

The "LCP Inline CW" 3311.530/540/560 variant is ideal for this form of cooling.

Why is a protruding and flush-mounted LCP Inline CW available for series cooling?

Protruding LCP Inline devices (3311.530/560) extend 200 mm in front of the bayed server racks into the cold aisle and are available with a maximum cooling output of 55 kW.

This has the advantage that the device fans can blow freely left and right directly in front of the server racks. This produces a cold air curtain in front of the perforated server racks so that the 19" equipment can draw in cold air unimpeded.

If no aisle containment is used, the cold air curtain prevents the drawing-in of any recirculated air from the hot aisle.

The flush LCP Inline (3311.540) is installed flush with the bayed server racks with which it forms a continuous front. The maximum cooling output of the device is 30 kW.

The flush LCP Inline is deployed when the escape route is impaired in a narrow cold aisle by protruding devices.

Can the quantity of heat removed be controlled dependent on the heat loss?

The controlled variable for the Liquid Cooling Package is the temperature of the air blown at the front of the 19" level. This value is available in the manufacturer's instruction manual.

The default setpoint of the LCP is 22°C. This value will then be kept constant regardless of any changes in the required cooling capacity.

This occurs through the appropriate automatic opening and closing of the 2-way valve. Additionally, the necessary fan output is adjusted based on the difference between the server outlet temperature and the setpoint temperature.

In this manner, the Liquid Cooling Package always cools only as much as is necessary without wasting energy. This also reduces problems arising from condensation and desiccation that stem from overcooling.

19 Frequently Asked Questions (FAQ)

EN

How is the airflow in the enclosure / enclosure suite achieved, and what advantages does this have?

As a general rule, the "front to back" cooling principle is used in server enclosures; cold air is supplied at the front of the enclosure. The units built into the enclosure have their own fans that draw in this air and use it internally for cooling. The heated air is exhausted to the rear.

The special horizontal air routing of the Liquid Cooling Package, which is adapted especially to this widespread cooling principle, evenly supplies cooled air to the complete height of the server enclosure. This means that all units, independent of their installation position in the enclosure and their load state, receive sufficient cold air.

Temperature gradients are avoided, so that an extremely high cooling capacity can be achieved for each enclosure.

Can the LCP Rack be operated with opened//perforated rack doors?

The response of the Liquid Cooling Package upon operation with opened doors depends mainly on the prevailing ambient conditions. If a front door is opened, the cool air is mixed marginally with the ambient air. Thus, no cooling problems are expected in air-conditioned rooms.

Overall, no heat is issued to the room. The back door should only be opened briefly during operation, since this breaks the cooling air circuit and causes the waste heat to be issued to the room. However, this does not influence the cooling of the units in the enclosure.

Why is the Liquid Cooling Package, as an air/water heat exchanger, designed for side installation?

It was important to develop a high performance cooling system which would also meet the requirements of the coming years. This could only be achieved routing the cooling air in a manner which was tailored to the needs of the devices. The main problem associated with cooling by air from the raised floor or with top or bottom heat exchangers is air routing.

Cold air which is fed into the enclosure from below or above changes its temperature greatly because of recirculation. In data centres, temperature differences of up to 20°C occur between the bottom and top of the enclosure, so that a server fitted in a low position in the enclosure benefits from temperature conditions up to 20°C 'better' than one at the top.

Because of this, in order to achieve sufficient cooling of all systems in the rack when using this sort of cooling, a significantly lower air temperature must be used. Where cooling air is supplied from the side, however, this problem does not arise – the cooling is distinctly more efficient and precise and the air available to the devices can be kept to within 1-2°C.

Because the system is built as its own enclosure, the system is protected against the risk of leaks. All water-

carrying parts are located outside of the actual server enclosure. Connection to the cooling water network also is made in the floor there.

Further, Rittal has many years of experience in the field of air/water heat exchangers. All of this experience is incorporated into the construction of the Liquid Cooling Package. Because of these precautionary measures, even in the event of a – very unlikely – leak, water cannot find its way into the area for electronic components.

The 'slimline' width of only 300 mm also avoids disrupting the matrix in the data centre. Because the depth of the enclosures is not increased, the full width of the aisles in the data centre is maintained.

How is water connected to the Liquid Cooling Package?

Connection to the building network or the re-cooler may be made either from below or from the top. A 1½" screw-fastening with external thread is installed in the LCP.

The mating component to be installed must be a 90° bend with union nut because space considerations mean the 90° bend in the device cannot be turned through its own axis.

An appropriate hose pair (inlet, outlet), for connection of the LCP, however, can also be ordered as accessory.

The article number of the connection hose is 3311.040. Each part of the hose pair is 1.8 m long. If required, the hose can be shortened to the required length on-site.

Can both air-cooled and water-cooled server enclosures operate side-by-side in a data centre?

Certainly, only a cooling water installation must be available for the cold water supply.

This has the advantage that the existing room air conditioning is not further burdened. Consequently, Liquid Cooling Package systems can be used to intercept "hot-spots" in the data centre without requiring the expansion of the air-conditioning system.

With which dimensions is the Liquid Cooling Package available?

The Liquid Cooling Package itself has the dimensions 300 x 2000 x 1000/1200 mm (W x H x D). Every Rittal enclosure with the dimensions 2000 x 1000/1200 mm (H x D), independent of the width, can be bayed. Other sizes are available on request.

Does the Liquid Cooling Package require maintenance?

The Liquid Cooling Package itself is maintenance-free. All components are designed with an extremely long lifespan. In case of a malfunction, a message is generated by the alarm output of the control unit or the CMC III PU.

We recommend, however, that any water filter installed in front of the LCP is checked at regular intervals and cleaned if necessary.

The piping in and to the LCP should be checked yearly for leaks.

What advantages does a water-cooled solution have over an air-cooled solution in a data centre?

The use of water-cooled enclosures allows for the controlled, efficient and cost-saving cooling of heat losses, something not possible with conventional air conditioning.

Thus, it is possible to fully use the space physically available in the enclosures, instead of being forced to erect "half-empty" enclosures because of air conditioning problems.

This achieves considerable savings in the investment and operating costs of a data centre.

Is a raised floor necessary for installation? If yes, what height is required?

A raised floor is not required for routing the cooling water pipes. In principle, the pipes can also be laid in channels in the floor.

The LCP is always also prepared for water connection from above.

If the water supply should be provided using a raised floor, a minimum height of 300 mm is required in order to achieve the required bending radii of the connection hoses or piping.

Can LCP-cooled enclosures also be bayed with one another?

Basically, the Liquid Cooling Package is just a "small" enclosure. That means that all accessories for baying may be used. Thus, LCP-cooled systems may be bayed without limitation.

How is condensate formation prevented in the Liquid Cooling Package?

Condensate can occur only where water is cooled below the dew point.

When the air temperature falls, the air loses its ability to accept or "hold" water and any excessive water will be dissipated as condensate at the coldest point, in the case of the LCP, at the heat exchanger.

The Liquid Cooling Package normally works with water temperatures above the dew point and so precludes condensate formation.

If the cold water system is operated with water inlet temperatures below the dew point, there are various ways of increasing the water inlet temperature (to the LCP).

The use of a water/water heat exchanger allows an existing cold water system to be split into a primary and a secondary circuit.

In the primary circuit, the water circulates from the cooling source that lies below the dew point. In the secondary circuit, the inlet water to the LCP is raised to a temperature level above the dew point and so condensate formation in the LCP prevented.

A water/water heat exchanger has the additional advantage of reducing the water volume in the secondary circuit. Should a very infrequent leakage occur in the secondary circuit, only the small water volume of the circuit can escape.

The water quality in the secondary circuit itself can be defined so that any heavily contaminated primary circuit water cannot enter the data centre environment.

To increase the water inlet temperature above the dew point, an agitator or an injection system can also be installed in the water circuit to the LCPs.

In this case, the cold inlet water is mixed with hot water from the outlet and so also achieves a water inlet temperature above the dew point.

Why is the prevention of condensate formation in the LCP desirable?

Condensate formation also means dehumidification of the air.

The total cooling output of the LCP always consists of an amount of latent and sensitive cooling output.

When water inlet temperatures above the dew point are used, no dehumidification (condensate formation) occurs and the share of the latent cooling output is zero. The complete sensitive cooling output can be used to cool the air.

Dehumidification with the latent cooling output requires energy that is then no longer available for cooling the server inlet air. The share of the sensitive cooling output is correspondingly less and less cooling output for the same energy input available.

This means generally a lower energy efficiency and additional devices need to be used to provide the same cooling output.

How is the condensate dissipated in the LCP?

In the 30 kW version of the LCP (3311.130/230/530/540), the condensate resulting at the heat exchanger is fed downwards into a condensate tray. From there, a condensate hose leads the condensate to the outside.

A spray eliminator is installed behind the heat exchanger. If condensate drops come in contact with the air flow, they are separated there and also fed downwards into the condensate tray.

Despite the condensate management, a water inlet temperature above the dew point is recommended to prevent condensate formation.

The 55 kW version of the LCP (3311.260/560) does not provide any condensate management.

19 Frequently Asked Questions (FAQ)

EN

For these devices, the water inlet temperature must lie above the dew point in order to prevent condensate formation.

Is a condensate pump installed in the LCP?

No, a condensate pump is not installed as standard because the devices are normally operated at temperatures above the dew point.

If required, a condensate pump can be installed on request.

If several LCPs are used in an installation, the installation of a condensate pump in each LCP makes no sense. In this case, the standard condensate discharges of the devices without pressure should be grouped centrally and the condensate discharged using a dual-pump lifting system installed by the customer.

What must be considered for the condensate connection of the LCP?

The condensate discharge of the LCP systems must not be connected directly to the waste water system. An odour trap must be installed between the systems. The condensate pump does not provide any protection against back-pressure and return waste water. The relevant engineering practice must be observed for the connection of the condensate tray.

Is the LCP protected against leaks?

Yes, the LCP has an integrated leak monitoring.

If excessive liquid escapes from the device, this will be detected and signalled with an internal sensor. If required, only a signal is issued, or, in addition, the device control valve closed immediately to prevent the intrusion of further cooling water.

How does the Liquid Cooling Package prevent desiccation of the air?

If the LCP is operated with a water temperature above the dew point, no dehumidification occurs and so the air is not desiccated.

This makes the system dependent on the humidity present in the ambient air.

In most cases, the data centre is climate-controlled using an air-conditioning system that also regulates the relative humidity to above 30% and so in the uncritical range with regard to static charge.

Why does the LCP Rack offer the option of cooling either one or two enclosures?

The most important design principle was a flexible cooling system which would correspond to the enormous volume of air required by a modern server. Because of the horizontal cooling possibility, options for "right", left or "both-sided" cooling arise in combination with the chosen fans. Cooling a server rack with two Liquid Cooling Packages has the advantage of complete sys-

tem redundancy without further installation of 19" equipment.

In which applications and situations should an LCP system be used?

Whenever the cooling capacity of the room air-conditioning system is not sufficient to handle the heat loads of current high performance servers. With an optimal design in a newly planned data centre, this limit is at about 1,000 – 1,200 W/m²; in older data centres, it is often significantly below that.

At best, a maximum of 4 kW per rack needs to be removed. This value is much larger, however, for racks filled with blade servers.

But the Liquid Cooling Package represents a possible solution even in applications where there is no existing air-conditioning system. In combination with Rittal re-cooling systems, even climate control solutions for high performance cluster systems can be created.

What additional infrastructure is required to operate the LCP?

In addition to the Liquid Cooling Package, pipes to the individual enclosures and a system for generating the cooling water are required.

With single enclosures, a direct connection with the cooling water suffices. With multiple enclosures, a cooling water distribution system should be provided.

To a great degree, this infrastructure corresponds to that already used in a conventionally air-conditioned data centre. The "cold" water is provided by water chillers (with adequate redundancy, especially in regard to the pumps). The water is distributed over a cooling water network in the data centre to air-circulation cooling units or ceiling cooling units.

Which key disadvantages of today's air-cooled solutions are remedied by water cooling?

The main problem of conventional cooling involves directing large amounts of cool air through raised floors, suspended ceilings and within the room. Often, because of complex flow conditions, the cold air does not reach the servers in sufficient quantities.

There is actually enough cold produced and often, the cooling output from raised floor systems lies far above the electrically connected load of the unit that needs to be cooled, but in spite of this, the cooling is insufficient. This effect is explained by the fact that the cooling air is already warmed too much through recirculation on its way to the server or the cooling air does not even reach the IT equipment because of a "blocked" raised floor.

By using water to lead the heat loss out of the enclosure, an excellent separation between cold air and removed thermal energy is achieved. Because of its material characteristics, water can transport thermal energy almost 4,000 times "better" than air. Small pipes are capable of transporting very large quantities of heat.

Can the divided side panels of the TS IT rack also be used for the LCP?

If the LCP is located at the end of a rack row, the open side of the device must be closed with a side panel. The divided side panels of the TS IT cannot be used for this purpose; single-piece, screwed-on side panels must always be used.

Up to what depth may servers be installed?

Modern server systems have a depth of approx. 800 mm. Consequently, it is recommended for rack-based cooling with LCP that the 482.6 mm (19") level in the enclosure be installed so that the same distance remains to the door in front and in back.

In the front area, the distance (ideal approx. 200 mm) must be sufficiently large so that the cold supply air can be blown unimpaired in front of the IT equipment.

In combination with the space on the side between the 482.6 mm (19") level and the Liquid Cooling Package, sufficient room for the air which is fed or emitted is achieved. The side openings do not need to be completely "open" throughout their depth.

How is the LCP connected electrically?

The standard connection of the device is 230 V, 1~, 50/60 Hz, i.e. only single-phase components may be installed in the device.

The LCP itself has a 5-pin connection socket at the rear of the device.

A 5-pin connector plug is included in the accessories kit for the 230 V, 1~, 50/60 Hz connection. The power-conducting phase is already jumpered to the two other phase terminals in the plug.

If the Liquid Cooling Package is connected to the mains using a 5-conductor connection cable (400 V, 3~, N, PE; DK 7856.025), three separate phases (L1, L2, and L3) are available.

If one connection phase fails, the device continues to be supplied with power and remains operational as follows:

Failure in phase L1:

The fans at positions 1 and 2 switch off, the fans at positions 3 to 6 remain operational.

Failure in phase L2:

The fans at positions 3 and 4 switch off, the fans at positions 1 and 2 as well as 5 and 6 remain operational. The optionally installed condensate pump also no longer receives any supply voltage.

Failure in phase L3:

The control unit (CMC III PU with special LCP software) no longer receives any supply voltage. The fans at positions 5 and 6 switch off. Because of the missing setpoint

from the control unit, the fans at positions 1 to 4 enter a so-called "fail-safe" operation with 100% fan speed.

How is the network connected to the LCP?

The RJ 45 socket for the network connection is located at the rear of the device.

The default IP address of all LCPs is 192.168.0.190. Detailed explanations for establishing the network connection are contained in the operating manual.

Does the LCP have installed levelling feet?

No, the device does not have any levelling feet.

If these are required, they can be ordered with article number 4612.000 (adjustment height 18–43 mm) or 7493.100 (adjustment height 18–63 mm).

How many fan modules are installed as standard in the LCPs and what is the maximum number of fan modules for each device?

One fan module is installed in the factory for LCP types 3311.130/230/530. A maximum of five additional fan modules can be integrated. This means, a maximum of 6 fan modules can be installed.

Two fan modules are installed in the factory for LCP type 3311.540. A maximum of two additional fan modules can be integrated. This means, a maximum of 4 fan modules can be installed.

Four fan modules are installed in the factory for LCP types 3311.260/560. A maximum of two additional fan modules can be integrated. This means, a maximum of 6 fan modules can be installed.

Why can fans be re-equipped modularly for the LCP?

The full cooling output of the LCPs is often not required immediately after the construction of a data centre (DC). It suffices to begin with a minimum fan configuration for each LCP.

This save investment costs.

When the heat loss in the DC increases over the course of time, additional fan modules can be installed as required and the cooling output of the LCPs so increased (pay as you grow).

However, with regard to the possible energy savings, it makes sense to fully equip an LCP with fan modules directly at the beginning.

For example, the LCP 3311.130/230 types have a cooling output of 30 kW (at 4500 m³/h air volume flow) with three integrated fan modules. The electrical power consumption of 1100 W is measured for the complete device.

19 Frequently Asked Questions (FAQ)

EN

If, however, six fan modules are used in the devices for the same air volume flow (4500 m³/h), their speed reduces significantly compared with three fan modules. For the same cooling output of 30 kW, an electrical power consumption of 600 W is measured for the complete device.

This is equivalent to a saving of 45% and so produces a direct saving of the operating costs.

In addition, increasing the number of installed fan modules can guarantee a redundancy.

Activation/deactivation of fan modules

If additional fan modules are installed in the LCP, they must be activated via the web interface or the display on the device. Only then are the fans displayed and monitored in the software.

If fan modules are removed, they must be deactivated otherwise error messages will be generated.

What accessories are available for the LCP?

Connection hose, 3311.040:

The flexible connection hose is used to bridge the "last meter" from the piping installed by the customer to the LCP.

If the LCP is connected with rigid piping, inaccurate work can produce tensions at the water connection and cause leaks.

This can be avoided with the use of the flexible connection hose.

Each part of the hose pair is 1.8 m long. If required, the hose can be shortened to the required length on-site.

The hose has a 90° bend at one end and a straight fitting at the other end, each with a 1½" union nut.

Fan module, 3311.010

This fan module can be used for devices 3311.130/230/260/530/560 whose serial number is less than 300.000.

To increase the cooling output, further individual fan modules can be installed subsequently in the LCPs. This can achieve a redundancy, or a reduction the electrical power consumption of the LCP.

Fan module, 3311.011

This fan module can be used for devices 3311.130/230/260/530/560 with serial number larger than 300,000 and for device 3311.540.

To increase the cooling output, further individual fan modules can be installed subsequently in the LCPs. This can achieve a redundancy, or a reduction of the electrical power consumption of the LCP.

Touchscreen display, 3311.030

The coloured display can be used to monitor important functions of the LCPs directly on the device and make settings (setpoint, fan activation/deactivation).

The LCP display can also be upgraded.

Rear adaptor, 3311.080

This can be placed on the rear of the protruding LCP In-line CW (3311.530/560) to close the gaps present in the rear area.

What position does the LCP control valve have when disconnected from the mains?

The control valve is open when disconnected from the mains.

This ensures that the full cooling output is available in the case of wire breakage or failure of the control voltage from the controller.

What happens if the LCP control electronics fail?

In this case, the LCP enters the so-called "Emergency Mode".

The control valve opens at 100% (full water flow rate) the fans control to the maximum fan volume flow.

This so ensures the full cooling output in this "exceptional situation".

20 Glossary

1 U server:

1 U servers are very flat and deep, modern high performance servers, whose height corresponds to one height unit (1 U = 44.54 mm, the smallest standard height division). Typical dimensions are (W x D x H) 482.6 mm (19") x 800 mm x 1 U.

These systems normally include 2 CPUs, many GB RAM and hard drives, so that they require up to 100 m³/h cooling air at a maximum of 32°C.

482.6 mm (19") level:

The front sides of the devices built into the server enclosure form the 482.6 mm (19") level.

Blade server:

By orienting dual CPU systems vertically and placing up to 14 units on a common backplane to provide for signal routing and power supply, one has a blade server.

Blade servers can "generate" up to 4.5 kW heat loss per 7 U and 700 mm depth.

"Front to back" cooling principle:

The devices built into the server enclosure are normally cooled according to the "front to back" cooling principle.

Under this cooling principle, cold air supplied by external air conditioning is blown to the front of the server enclosure. The fans in the devices built into the server enclosure direct this air horizontally through the server enclosure. The air is warmed through this process and is exhausted out the rear of the enclosure.

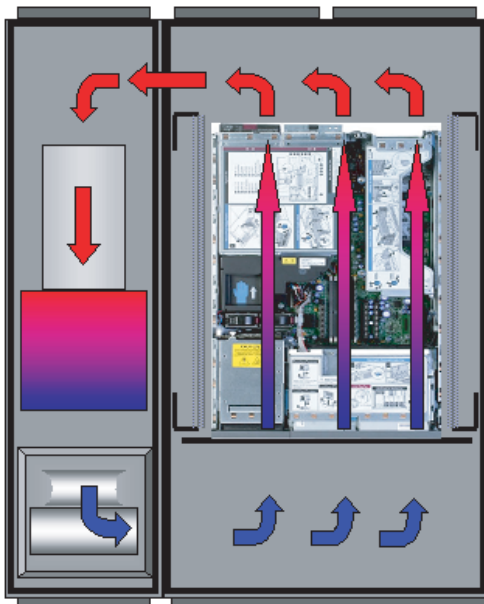

Fig. 96: "Front to back" cooling principle with bayed LCP Rack

Hotspot:

A hotspot is the concentration of thermal energy in a small area.

Hotspots normally lead to local overheating and can cause system malfunctions.

Air/water heat exchanger:

Air/water heat exchangers operate according to the same principle as automobile radiators. A liquid (water) flows through the heat exchanger, while, at the same time, air is blown over its surface area (which is as large as possible), facilitating energy exchange.

Depending on the temperature of the circulating liquid (water), an air/water heat exchanger may either heat or cool the circulated air.

Recooling system:

As an initial comparison, a recooling system is like a refrigerator – through an active cooling circuit, unlike a household refrigerator, a recooling system produces cold water. The thermal energy which is removed from the water is dissipated to the outside by fans. Because of this, it is normally advisable to locate recooling systems outside of buildings.

Recooling systems and air/water heat exchangers form a complete cooling solution.

Switch:

Multiple servers normally communicate with one another and in the network using switches.

Because as many inputs as possible are located on the front of switches, they frequently have an airflow from the side, not "front to back" cooling.

Hysteresis:

If an upper limit value is overshoot (SetPtHigh) or a lower limit value is undershot (SetPtLow) a warning or an alarm will be output immediately. For a hysteresis of x%, the warning or alarm for undershooting an upper limit value or overshooting a lower limit value clears only for a difference of $x/100 \cdot \text{limit value}$ to the limit value.

21 Customer service addresses

EN

21 Customer service addresses

For technical questions, please contact:

Tel.: +49(0)2772 505-9052

E-mail: info@rittal.de

Homepage: www.rittal.com

For complaints or service requests, please contact:

Tel.: +49(0)2772 505-1855

E-mail: service@rittal.de

Rittal – The System.

Faster – better – everywhere.

- Enclosures
- Power Distribution
- Climate Control
- IT Infrastructure
- Software & Services

RITTAL GmbH & Co. KG
Postfach 1662 · D-35726 Herborn
Phone +49(0)2772 505-0 · Fax +49(0)2772 505-2319
E-mail: info@rittal.de · www.rittal.com

ENCLOSURES

POWER DISTRIBUTION

CLIMATE CONTROL

IT INFRASTRUCTURE

SOFTWARE & SERVICES

FRIEDHELM LOH GROUP

