

### Horní díly pultu

Šířka 600/800 mm  
TP 6720.500, TP 6721.500

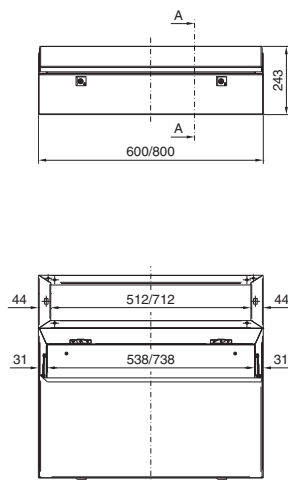

Šířka 1200/1600 mm  
TP 6722.500, TP 6723.500

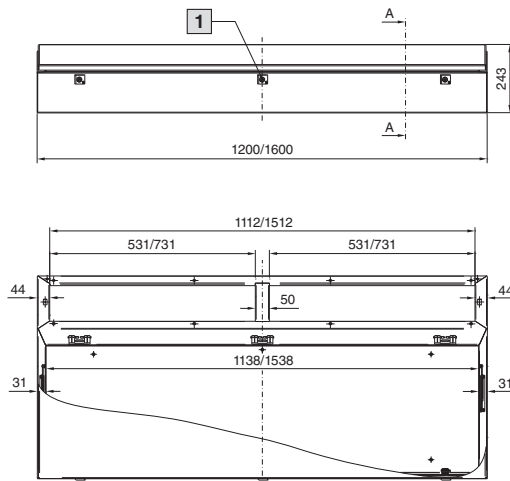

Řez A - A

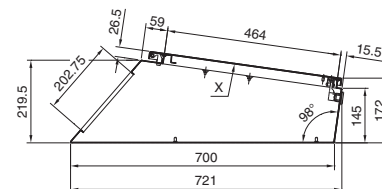

1 Pouze při šířce 1600 mm

**Upozornění:**  
- Pohled X, viz strana 2

### Střední díly pultu, připravené pro horní díl pultu

Šířka 600/800 mm  
TP 6714.500, TP 6715.500

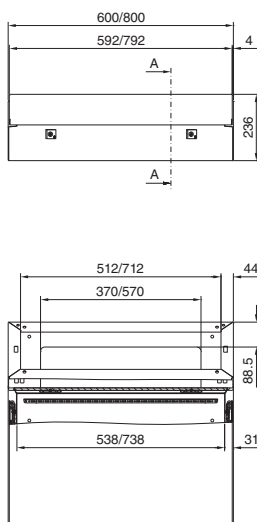

Šířka 1200/1600 mm  
TP 6716.500, TP 6717.500

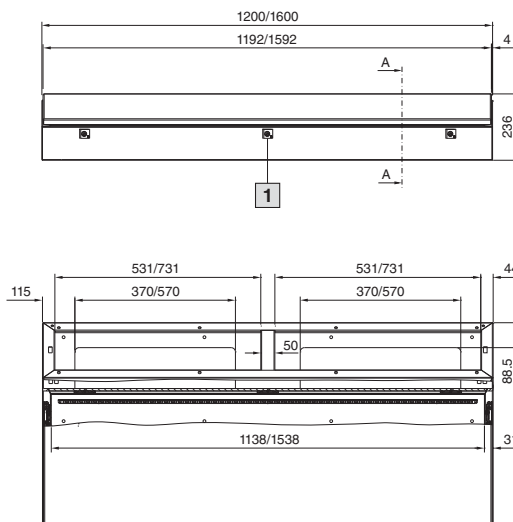

Řez A - A

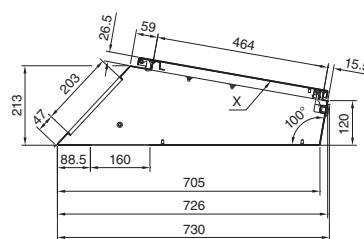

1 Pouze při šířce 1600 mm

**Upozornění:**  
- Pohled X, viz strana 2

# Rozváděčové skříně

## System TopPult TP

### Střední díly pultu, vzadu s krytem se závěsy

Šířka 600/800 mm  
TP 6710.500, TP 6711.500

Šířka 1200/1600 mm  
TP 6712.500, TP 6713.500

Řez A – A

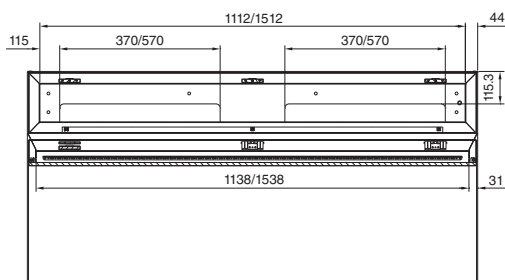
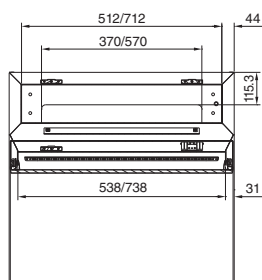
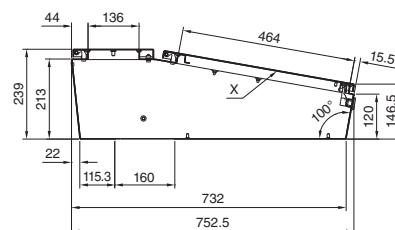
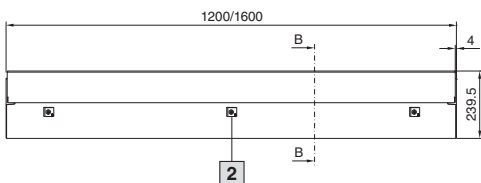
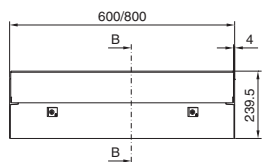

Pohled X

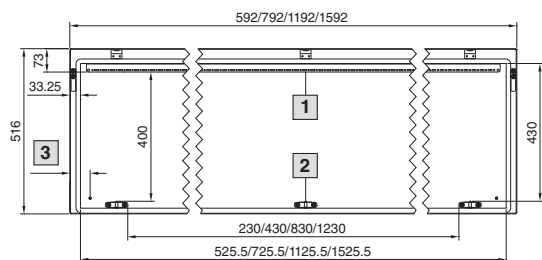

- 1 Odpadá při šířce 600/800 mm
- 2 Pouze při šířce 1600 mm
- 3 Šířka = 600/800/1200 = 63,5 mm  
Šířka = 1600/163,5 mm

### Spodní díly pultu, hloubka 400 mm

Šířka 600/800 mm  
TP 6700.500, TP 6701.500

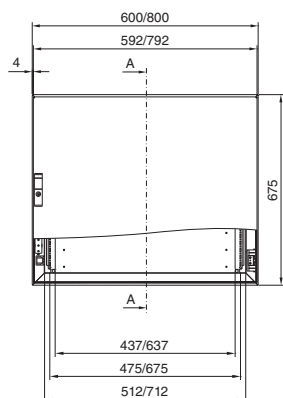

Šířka 1200/1600 mm  
TP 6702.500, TP 6703.500

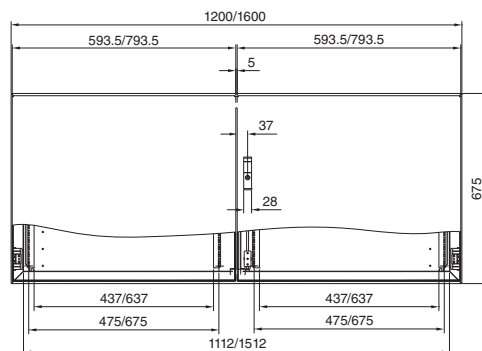

Řez A – A

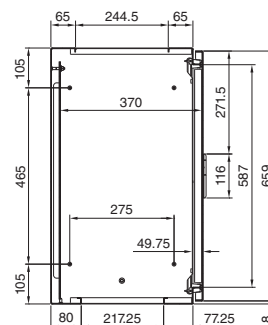

Montážní výřez

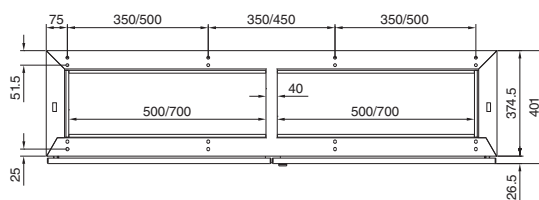
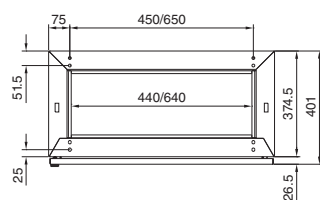
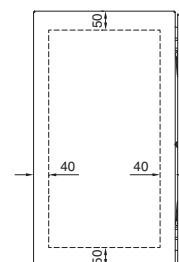

Montážní deska

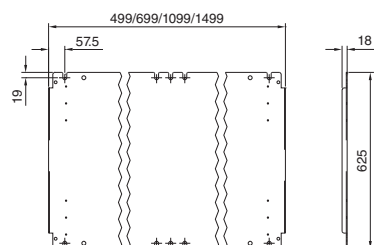

# Rozváděčové skříně

## System TopPult TP

### Spodní díly pultu, hloubka 500 mm

Šířka 600/800 mm  
TP 6704.500, TP 6705.500

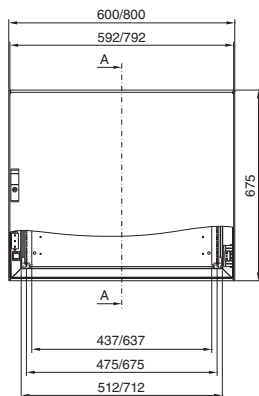

Šířka 1200/1600 mm  
TP 6706.500, TP 6707.500

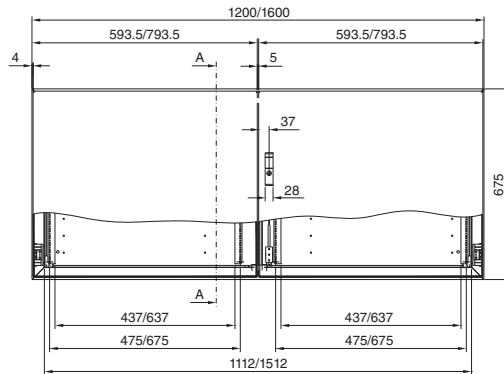

Řez A - A

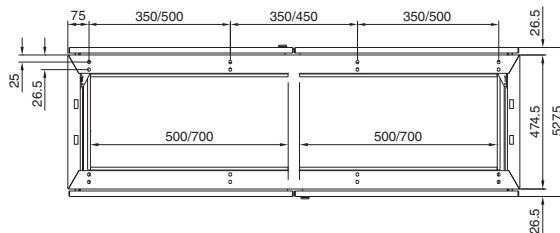
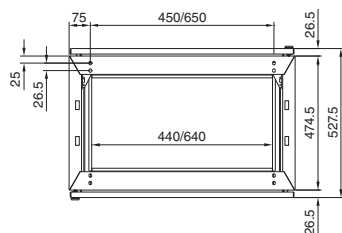
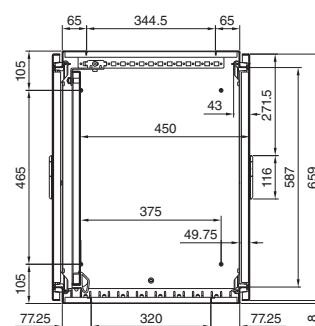

Montážní výřez

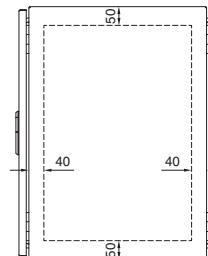

Montážní deska

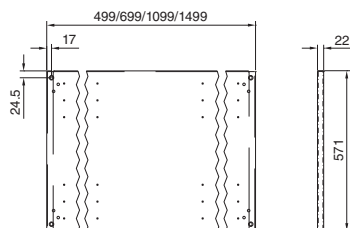

### Možnosti kombinací

Třídílná sestava

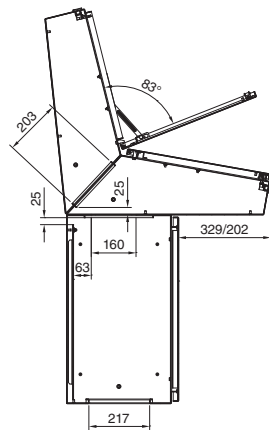
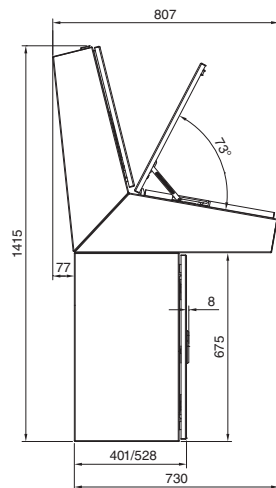

Dvoudílná sestava

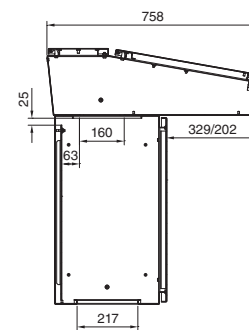
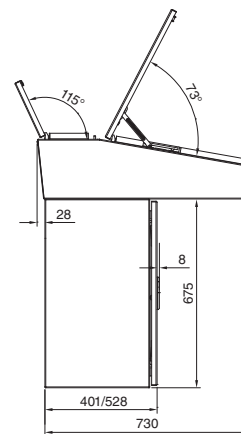

Jednodílná konstrukce

