

ISV NH-SI-Trenner-Modul für NH2

SV 9666.410

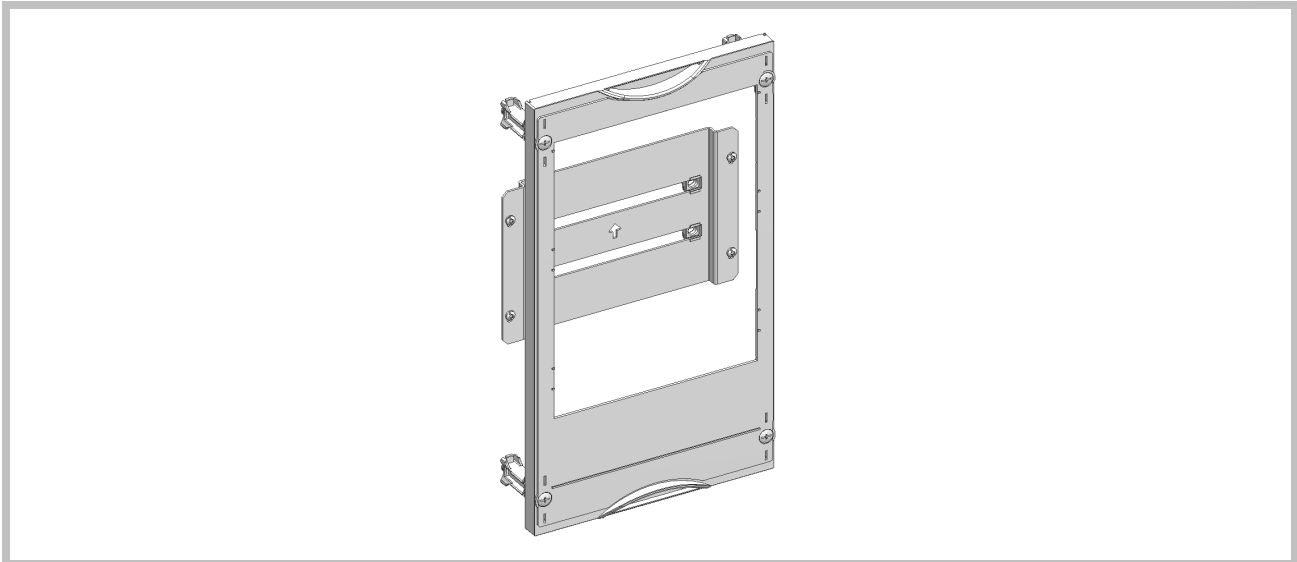

		SV 9666.410			
	1		4	x	
	2		1	x	
	3		4	x	
	4		1	x	

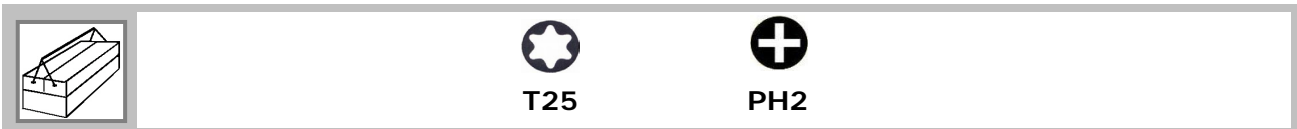

TS8

AE

	A	B
SV 9666.410	450	250

Var.1

Var.2

ISV NH-SI-Trenner-Modul für NH2

SV 9666.410



1 4x

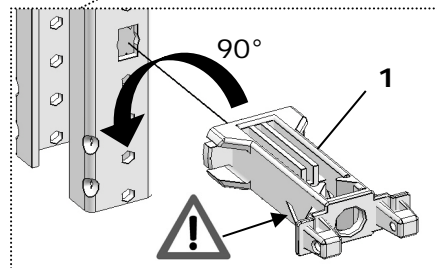
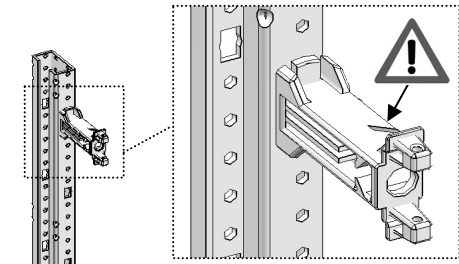
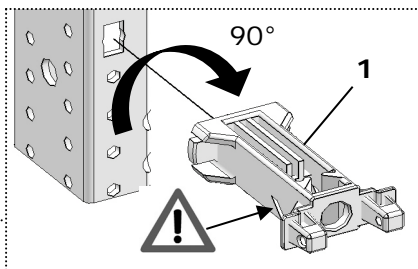
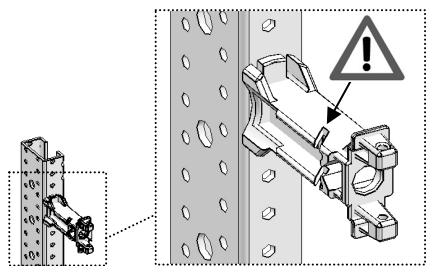

1

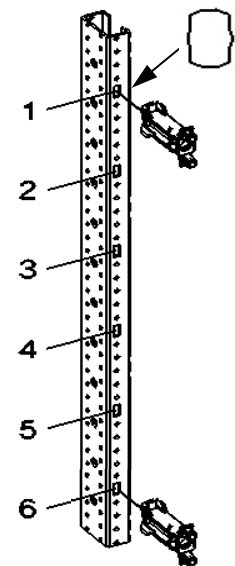

SV 9666.410	1 / 3	1 & 6
-------------	-------	-------

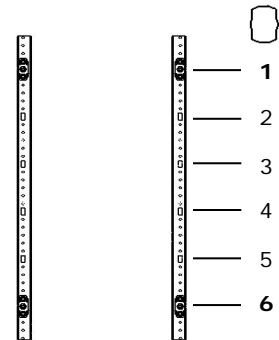





1.1

ISV NH-SI-Trenner-Modul für NH2

SV 9666.410

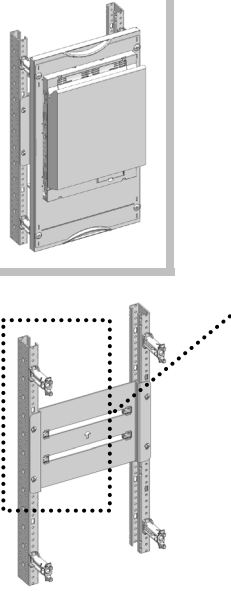
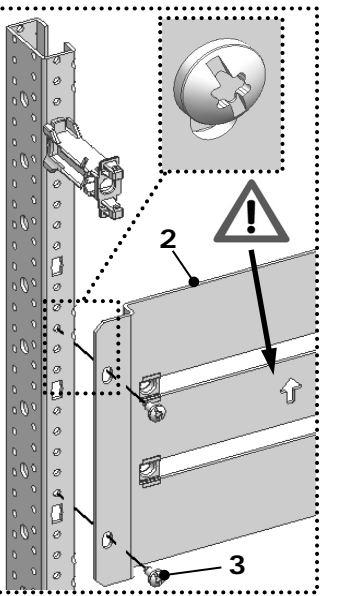
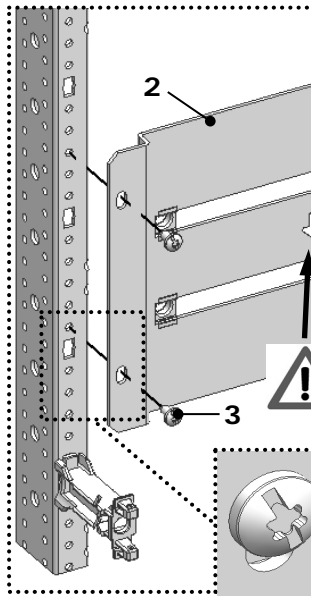
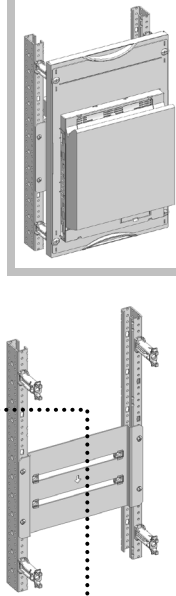
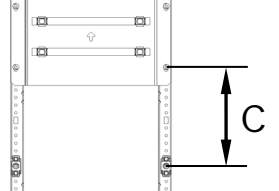
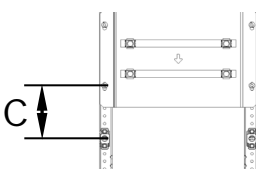

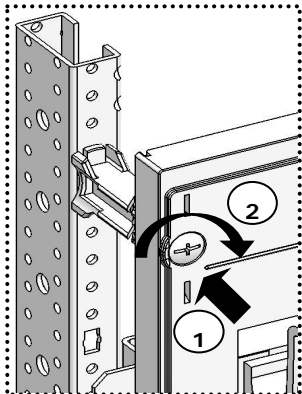
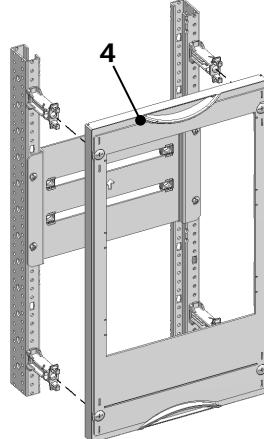
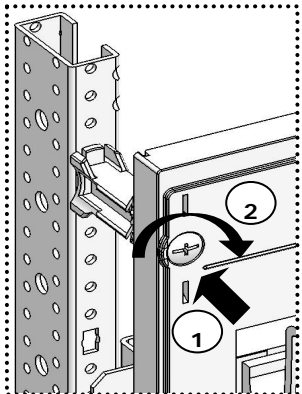
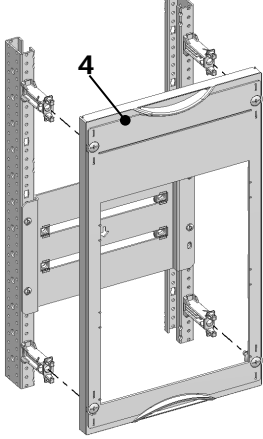
2  1x	3  4x 4,8x11,5		 T25 AE / 2Nm TS8 / 5Nm						
									
2.2 <table border="1" data-bbox="239 985 454 1086"> <tr> <td>Var1</td> <td>c</td> </tr> <tr> <td></td> <td>162,5</td> </tr> </table> 	Var1	c		162,5	 <table border="1" data-bbox="1109 996 1332 1086"> <tr> <td>Var2</td> <td>c</td> </tr> <tr> <td></td> <td>87,5</td> </tr> </table> 2.2	Var2	c		87,5
Var1	c								
	162,5								
Var2	c								
	87,5								
4  1x		 PH2							
 	 								
3.2 <table border="1" data-bbox="231 1982 359 2027"> <tr> <td>Var1</td> </tr> </table>	Var1	<table border="1" data-bbox="1204 1982 1332 2027"> <tr> <td>Var2</td> </tr> </table> 3.2	Var2						
Var1									
Var2									

ISV NH-SI-Trenner-Modul für NH2

SV 9666.410



DE

Arbeiten an elektrischen Betriebsmitteln/Anlagen dürfen nur durch eine ausgebildete Elektrofachkraft gemäß DIN 57105 Teil 1 / VDE 0105 Teil 1 / DIN EN 50110-1 durchgeführt werden.

GB

Only qualified electrical personell according to DIN 57105 part 1 / VDE 0105 part 1 / DIN EN 50110-1 are allowed to work on electrical installations.

ES

Sólo electricistas cualificados según norma DIN 57105 part 1 / VDE 0105 part 1 / DIN EN 50110-1 están autorizados a trabajar en instalaciones.

RU

Согласно DIN 57105, часть 1 / VDE0105, часть 1 / DIN EN 50110-1, на электрических установках разрешается работать только квалифицированному персоналу.

RITTAL GmbH & Co. KG
Postfach 1662 • D-35726 Herborn
Phone +49(0)2772 505-0 • Fax +49(0)2772 505-2319
E-Mail: info@rittal.de • www.rittal.de

EDV.-Nr.: 118471 / 1
02/12
printed in Germany

SCHALTSCHRÄNKE

STROMVERTEILUNG

KLIMATISIERUNG

IT-INFRASTRUKTUR

SOFTWARE & SERVICE



FRIEDHELM LOH GROUP