

Rittal – The System.

Faster – better – everywhere.

Enclosure cooling unit



SK 3185830
SK 3186930
SK 3187930
SK 3188940
SK 3189940

SK 3185835
SK 3186935
SK 3187935
SK 3188945
SK 3189945

SK 3185530
SK 3186630
SK 3187630
SK 3188640
SK 3189640

Assembly and operating instructions

ENCLOSURES

POWER DISTRIBUTION

CLIMATE CONTROL

IT INFRASTRUCTURE

SOFTWARE & SERVICES

FRIEDHELM LOH GROUP



Preface

Dear Customer!

Thank you for choosing a "Blue e+" enclosure cooling unit (referred to hereafter as "cooling unit") from Rittal.

Yours
Rittal GmbH & Co. KG

Rittal GmbH & Co. KG
Auf dem Stützelberg

35745 Herborn
Germany

Phone: +49(0)2772 505-0
Fax: +49(0)2772 505-2319

E-mail: info@rittal.com
www.rittal.com
www.rittal.de

We are always happy to answer any technical questions regarding our entire range of products.

Contents

1	Notes on documentation	4	7.3.2	Changing a parameter value	25
1.1	CE labelling	4	7.4	Information menu	25
1.2	Storing the documents	4	7.4.1	Temperature information	25
1.3	Symbols used in these operating instructions	4	7.4.2	Device information	25
1.4	Other applicable documents	4	7.4.3	Efficiency information	26
2	Safety instructions	5	7.5	Configuration menu	26
2.1	General safety instructions	5	7.5.1	Temperature	26
2.2	Operating and technical staff	5	7.5.2	Network	28
2.3	Other dangers when using the cooling unit ...	5	7.5.3	Alarm relays	29
2.4	IT safety instructions	5	7.5.4	Filter mats	29
2.4.1	Measures for products and systems	5	7.5.5	Language settings	30
3	Product description	7	7.5.6	Self-test	30
3.1	Functional description and components	7	7.6	System messages	30
3.1.1	Function	7	7.6.1	Occurrence of a malfunction	31
3.1.2	Description "chemical version"	7	7.6.2	Display in case of errors	31
3.1.3	Components	8	7.7	List of system messages	32
3.1.4	Control	8	8	Inspection and maintenance	35
3.1.5	Safety devices	8	8.1	Safety instructions for maintenance work ...	35
3.1.6	Condensation	8	8.2	Notes on the refrigerant circuit	35
3.1.7	Filter mats	9	8.3	Maintenance work on the cooling unit	35
3.1.8	Door limit switch	9	8.4	Compressed air cleaning	35
3.2	Intended use, foreseeable misuse	9	8.4.1	Dismantling a unit with full internal mounting	35
3.3	Scope of supply	10	8.4.2	Dismantling the unit	35
4	Transport and handling	11	8.4.3	Cleaning the components with compressed air ..	38
4.1	Delivery	11	8.4.4	Re-assembling the cooling unit	38
4.2	Unpacking	11	9	Storage and disposal	39
4.3	Transport	11	10	Technical specifications	40
5	Installation	12	11	List of spare parts	43
5.1	Safety instructions	12	12	Drawings	44
5.2	Siting location requirements	12	12.1	Representation of mounting cut-outs	44
5.3	Assembly procedure	12	12.2	Dimensions and installation depths	46
5.3.1	Assembly instructions	12	13	Accessories	49
5.3.2	Mounting options	13	14	Customer service addresses	50
5.3.3	Make a mounting cut-out in the enclosure	14	15	Compact service information	51
5.3.4	External mounting of the cooling unit	15			
5.3.5	Mounting the cooling unit externally on a 500 mm deep enclosure	16			
5.3.6	Partial internal mounting of the cooling unit	17			
5.3.7	Full internal mounting of the cooling unit	18			
5.3.8	Connect the condensate water discharge	18			
5.4	Electrical connection	18			
5.4.1	Notes on electrical installation	18			
5.4.2	Install the power supply	20			
5.4.3	Connect the alarm relays	22			
5.4.4	Interfaces	22			
6	Commissioning	23			
7	Operation	24			
7.1	General	24			
7.2	Updater program	24			
7.3	Layout of the display	24			
7.3.1	Start screen	24			

1 Notes on documentation

1.1 CE labelling

Rittal GmbH & Co. KG confirms the conformity of the cooling unit with the European Union's Machinery Directive 2006/42/EC and EMC Directive 2014/30/EU. A simplified declaration of conformity can be found in the assembly and installation instructions enclosed with the device (see also the Rittal website). These are the original operating instructions.



1.2 Storing the documents

The assembly and operating instructions as well as all other applicable documents are an integral part of the product. They must be issued to everyone who works with the unit and must always be available and on hand for operating and maintenance personnel.

1.3 Symbols used in these operating instructions

The following symbols are used in this documentation:



Danger!

A dangerous situation in which failure to comply with the instructions will result in death or severe injury.



Warning!

A dangerous situation which may cause death or serious injury if the instructions are not followed.



Caution!

A dangerous situation which may lead to (minor) injuries if the instructions are not followed.



Note:

Important notices and indication of situations which may result in material damage.

- This symbol indicates an "action point" and shows that you should perform an operation or procedure.

1.4 Other applicable documents

Assembly and operating instructions exist as paper documents and/or digital data carriers for the unit types described here and are enclosed with the equipment.

We cannot accept any liability for damage associated with failure to observe these instructions. Where applicable, the instructions for any accessories used also apply.

2 Safety instructions

2.1 General safety instructions

Please observe the following general safety instructions for the installation and operation of the system:

- Please be sure to observe the applicable regulations governing electrical installations of the country in which the cooling unit is installed and operated as well as national regulations for accident prevention. Please also observe any internal company regulations, such as work, operating and safety regulations.
- Use only original Rittal products or products recommended by Rittal in conjunction with the cooling unit.
- Please do not make any changes to the cooling unit that are not described in these operating instructions or other applicable assembly and operating instructions.
- The operational safety of the cooling unit is only warranted if used as intended. The technical specifications and limit values stated must not be exceeded under any circumstances. In particular, this applies to the specified ambient temperature range and IP protection category.
- Operating the cooling unit in direct contact with water, aggressive materials or inflammable gases and vapours is prohibited.
- Other than these general safety instructions, it is also vital to observe the specific safety instructions when carrying out the tasks described in the following chapters.
- Please note the maximum weights that may be lifted by individuals. It may be necessary to use lifting gear.
- Cooling units must be transported in an upright position and secured to prevent them from tipping over.
- Shipping braces (such as a structure made from square timbers or boards) must be used when transporting cooling units already mounted on the enclosure. These braces support the cooling unit and prevent it from slipping in case of impact.
- Use a sufficiently large pallet to prevent it tipping over.
- If the cooling unit has been mounted on a door, close the door and keep it closed during transportation.

2.2 Operating and technical staff

- The assembly, installation, commissioning, maintenance and repair of this cooling unit may only be performed by qualified, trained personnel.
- Only properly instructed personnel may operate a cooling unit with the system operational.
- Children and persons with limited cognitive/coordinate abilities must **not** operate, maintain or clean the unit or be allowed to use it as a toy.

2.3 Other dangers when using the cooling unit

When installing the cooling unit (see section 5 "Installation"), there is a risk that the enclosure could become unbalanced and tip over.

- In such cases, the enclosure should be bolted to the floor as a precaution.

If the air inlet or outlet of the cooling unit is obstructed, there is a risk of air short-circuits, resulting in inadequate climate control.

- Please ensure that the electronic assemblies in the enclosure are installed in accordance with section 5.3.1 "Assembly instructions".
- Where applicable, use suitable components to divert the air.
- Please observe the prescribed minimum distances at the installation site as outlined in section 5.3.1 "Assembly instructions".

2.4 IT safety instructions

To ensure the availability, confidentiality and integrity of data, products, networks and systems must be protected against unauthorised access.

Such protection can be achieved only with organisational and technical measures. To satisfy the increased safety requirements, Rittal recommends the observance of the following measures. Furthermore, more detailed information can be found on the websites of Bundesamt für Sicherheit in der Informationstechnik (Federal Office for IT Security – BSI).

2.4.1 Measures for products and systems

Embed products and systems not in public networks.

- Make sure that the system is only operated in protected networks.

Configure the firewall

- To protect your networks, and the embedded products and systems against external effects, configure a firewall.
- Also deploy a firewall for segmentation of a network or to isolate a controller.

Consider defence-in-depth mechanisms during the planning phase

- Consider defence-in-depth mechanisms for your system planning.
- Defence-in-depth mechanisms cover several levels of mutually coordinated security measures.

Restrict access authorisations

- Restrict access authorisations to networks and systems to only persons that need an authorisation.

2 Safety instructions

EN

Protect accesses

- Do not use the default passwords; instead, use secure, long passwords containing numbers, a mix of upper case and lower case letters, symbols and no repetitions.
- Create random passwords with a password manager.

Deploy the current firmware version

- Ensure that the current Rittal firmware is deployed on all devices.
- The firmware can be downloaded from the associated product pages in the Internet.
- Observe the associated Release Notes for new firmware versions.

Deploy current security software

- To identify and eliminate security threats, such as viruses, trojans and other malicious software, security software should be installed on all PCs and kept up-to-date.
- Deploy whitelist tools to monitor the device context.
- Deploy an intrusion-detection system to validate the communication of your system.

Perform regular threat analyses

- Rittal recommends that you perform regular threat analyses.
- The threat analyses allow you to determine whether your adopted measures are effective.

Protect USB ports against access

- USB ports must be protected against physical access. Ensure that no unauthorised persons have access to USB ports.
- Sensitive data can be read for an unauthorised access to USB ports.

3 Product description

3.1 Functional description and components

3.1.1 Function

There are two separate cooling circuits installed in the cooling unit.

- One conventional refrigerant circuit (compression system), and
- One heat pipe integrated into the condenser and evaporator coil.

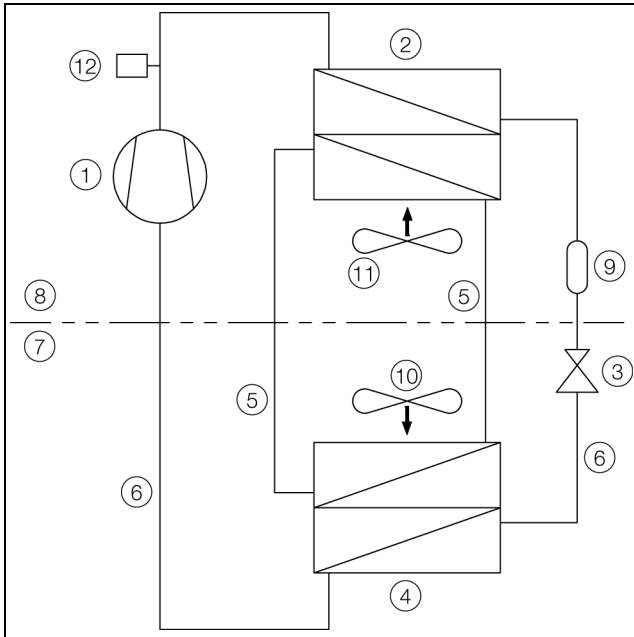

Fig. 1: Cooling circuit

Key

- | | |
|----|---|
| 1 | Compressor |
| 2 | Condenser (dual version) |
| 3 | Expansion valve |
| 4 | Evaporator coil (dual version) |
| 5 | Refrigerant circuit with heat pipe |
| 6 | Refrigerant circuit with compression system |
| 7 | Internal circuit |
| 8 | External circuit |
| 9 | Dryer/collector |
| 10 | Internal fan |
| 11 | External fan |
| 12 | PSA ^H pressure monitor |

In both cooling circuits, the individual components are connected with pipes in which the refrigerant is circulating. This refrigerant is very environmentally friendly, thanks to the following properties:

- Does not deplete the ozone layer (ozone destruction potential ODP = 0)

Refrigerant circuit with compression system

The refrigerant circuit with compression system is comprised of the following four main components:

1. Evaporator coil
2. Compressor
3. Condenser
4. Expansion valve

The evaporator coil fan draws hot air from the enclosure in the internal circuit of the cooling unit and passes it over the evaporator coil. After the evaporator coil, the cooled air is fed back into the enclosure via the outlet opening.

The air is cooled down by evaporating the refrigerant in the evaporator coil. The refrigerant vapour is transported by the compressor in the external circuit of the cooling unit to the condenser. There, the refrigerant condenses and becomes a liquid. The heat produced is dissipated by the condenser fan. The downstream electronic expansion valve reduces the high pressure of the refrigerant, and the refrigerant is then fed back into the evaporator coil.

Both the compressor and the two fans in the cooling unit are activated via an inverter. This makes it possible to control these components, so that the fan and compressor may be activated for a longer time but at a lower output and improved efficiency.

Refrigerant circuit with heat pipe

The additional second refrigerant circuit operates without a compressor, expansion valve or other control elements, and is integrated into the evaporator coil and condenser as a heat pipe.

The refrigerant inside the heat pipe absorbs thermal energy from the intake of enclosure air and evaporates. The gaseous refrigerant then rises through the pipeline until it reaches the condenser. The refrigerant is cooled down again in the condenser (provided $T_u < T_i$), and the heat released is emitted into the environment. Gravity then causes the liquid refrigerant to flow back down the pipelines. The whole cycle begins again.

3.1.2 Description "chemical version"

The following components of the cooling units are coated with an additional top coat of clear lacquer in the "chemical version" (standard paint in the chemical sector):

- All outer sheet metal parts (chassis and cover)
- I/O board
- Controller/display
- Inverter

The following components of the refrigerant circuit inside the cooling units that come into contact with the external polluted air are painted with 2-component PUR paint:

- Heat exchanger (condenser and evaporator) including pipe bends

3 Product description

EN

- Compressor
- Refrigerant lines and their soldered joints

The paint used is resistant to

- Mineral oils, vegetable oils
- Emulsions for metal cutting
- Nitrogen
- Ammonia vapours (<100000 ppm)
- Hydrogen sulphide (<0.2 ppm)
- Sulphuric acid and sulphurous acid vapours (<2 ppm)
- Vapours of organic carbon disulphides and CS₂
- Solutions pH 10 – pH 4 at room temperature
- Aqueous cleaners with surface-active substances, pH 10 – pH 4 at room temperature
- Diesel at room temperature
- 5 minutes exposure to ethanol, isobutanol, and petroleum ether at room temperature.

3.1.3 Components

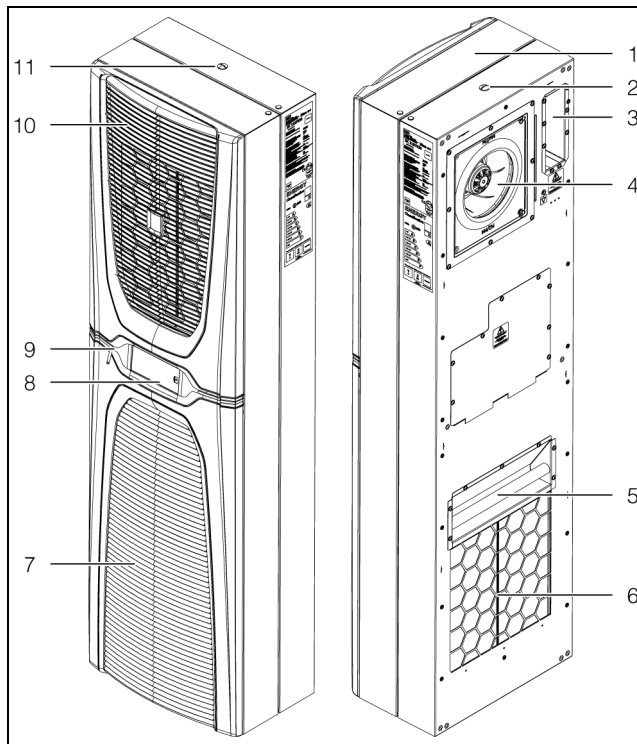

Fig. 2: Main components of cooling unit

Key

- 1 Cover
- 2 Chassis
- 3 Connection box
- 4 Evaporator fan
- 5 Handle
- 6 Air outlet opening
- 7 Lower louvred grille for air inlet
- 8 Display
- 9 Infill panel
- 10 Upper louvred grille for air outlet
- 11 Thread for eyebolt

3.1.4 Control

Rittal enclosure cooling units are fitted with a controller for setting the functions of the cooling unit.

Operation using this controller is described in section 7 "Operation".

3.1.5 Safety devices

- In the refrigerant circuit, the cooling units have a type-tested pressure monitor (to EN 12263) which switches off the cooling unit if the maximum admissible pressure is exceeded. Once the pressure drops back below the admissible pressure, the unit will automatically resume operation.
- Temperature monitoring prevents the evaporator coil from icing over. If there is a risk of icing, the compressor switches itself off and automatically switches itself back on again at higher temperatures.
- The compressor is monitored and protected by the inverter to prevent overloading.
- The fans have a built-in overload protection with automatic reset.
- In order to allow a reduction of pressure inside the compressor and hence a safe restart, once it has been switched off (e.g. upon reaching the set temperature via the door limit switch function or via de-energising), the device will switch back on with a delay of 180 seconds.
- The device has floating contacts on the connection pins on terminals 1 and 3 of the signal connector (X2), via which system messages from the device may be polled, e.g. using a PLC (2 x normally closed or normally open contacts).

3.1.6 Condensation

At high levels of humidity and low temperatures inside the enclosure, condensate water may form on the evaporator coil.

The cooling units have an automatic electrical condensate water evaporator. The thermal component used for this purpose is based on self-regulating PTC technology. Condensate water arising on the evaporator coil is collected in a tank in the external circuit of the cooling unit, and partially evaporated via the airflow. When the water level rises, the water enters the PTC thermal component and is evaporated (through-flow heater principle). The water vapour streams out of the cooling unit with the airflow from the external fan.

The PTC thermal component is activated automatically when the compressor is running, and continues to run for around 15 minutes after the compressor has been switched off. During the after-run phase, the condenser fan will likewise continue to run at low speed.

In the event of a short-circuit in the PTC component or if there is a risk of inverter overload (possible at high ambient temperatures), the PTC component will be deactivated. This means that any condensate water arising can be discharged via the safety overflow.

If the fuse has tripped, any condensate water is drained off via the safety overflow. The condensation is routed downwards out of the unit via a drain pipe on the evaporator coil divider panel. For this purpose, a hose may be connected to the condensate water nozzle (see section 5.3.8 "Connect the condensate water discharge").

3.1.7 Filter mats

The entire cooling unit condenser is covered with a dirt-repelling, easy-to-clean hydrophobic RiNano coating. In many applications, therefore, the use of filter media is unnecessary, particularly with dry dusts.

For dry, coarse dust and lint in the ambient air, we recommend installing an additional PU foam filter mat (available as an accessory) in the cooling unit. Depending on the incidence of dust, you will need to replace the filter mat from time to time (see section 8 "Inspection and maintenance").

For oily ambient air, we recommend the use of metal filters (also available as an accessory). These may be cleaned with suitable detergents and reused.

3.1.8 Door limit switch

The cooling unit may be operated with a floating door limit switch connected. The door limit switch is available as accessory from Rittal.

The door limit switch function causes the fans and the compressor in the cooling unit to gradually slow down and then switch off after approximately 15 seconds when the enclosure door is opened (contacts 5 and 6 closed). This prevents the formation of condensate water inside the enclosure while the enclosure door is open. In order to prevent damage to the unit, it is equipped with an ON delay: The evaporator fan will cut in again after a delay of a few seconds on closure of the door.

Please note that no external voltage may be applied to the door contacts (connection clamps 5 and 6).

3.2 Intended use, foreseeable misuse

The cooling unit is intended exclusively for cooling closed control cabinets as well as for professional use. Any other use is not permitted.

The cooling unit is intended for indoor and semi-outdoor use as standard. Semi-outdoor use is defined as follows:

- Siting in a roofed outdoor area.

The cooling unit is protected from the direct impacts of weather conditions such as precipitation or permanent sunlight.

- Always use within the admissible temperature range.
- The device is secure from unauthorized public access.

The cooling unit must not be installed and operated in locations which are accessible to the general public.

The cooling unit is designed solely for stationary use.

The cooling unit must not be used in environments with conductive, flammable and explosive dusts.

These include:

- Graphite dusts
- Metal dusts
- Cereal dusts
- Wood dusts
- Textile fibres and lint

The cooling unit is state of the art and built according to recognised safety regulations. Nevertheless, improper use can pose a threat to the life and limb of the user or third parties, or result in possible damage to the system and other property.

Consequently, the cooling unit must only be used properly and in a technically sound condition! Any malfunctions which impair safety should be rectified immediately.

Proper use also includes the observance of the documentation provided, and compliance with the inspection and maintenance conditions.

Rittal GmbH & Co. KG is not liable for any damage which may result from failure to comply with the documentation provided. The same applies to failure to comply with the valid documentation for any accessories used.













Inappropriate use may be dangerous. Examples of inappropriate include:

- Use of the cooling unit over long periods with the enclosure open.
- Use of impermissible tools.
- Improper operation.
- Improper rectification of malfunctions.
- Use of accessories not approved by Rittal GmbH & Co. KG.

3 Product description

EN

3.3 Scope of supply

Description	Illustration	SK 3185x3x	SK 3186x3x SK 3187x3x	SK 3188x4x SK 3189x4x
Enclosure cooling unit			1x	
Shipping bag with – Assembly and installation instructions			1x	
– Grub screw M8 x 40 mm			6x	
– Nut M8			6x	
– Washer M8			6x	
– Sealing tape 10x10 mm		1x2.7 m	1x4.1 m	
– Spring terminal		4x	6x	
– Corner bracket			4x	
– L-shaped bracket		2x	–	
– Clip			2x	
– Attachment for partial installation			1x	
– T-rail			1x	
– Connector			1x	
– Signal connector			1x	
– Ferrite core			1x	

Tab. 1: Scope of supply

4 Transport and handling

4.1 Delivery

The cooling unit is supplied in one packaging unit.

- Check the packaging carefully for signs of damage. Traces of oil on damaged packaging indicate a loss of refrigerant and/or a leak in the cooling unit. Any packaging damage may be the cause of a subsequent functional failure.

4.2 Unpacking

- Remove the packaging materials from the cooling unit.



Note:

After unpacking, the packaging materials must be disposed of in an environmentally friendly way.

- Check the cooling unit for any damage that may have occurred during transport.



Note:

Damage and other faults, e.g. incomplete delivery, should be reported immediately, in writing, to the shipping company and to Rittal GmbH & Co. KG.

- Check the supply contents for completeness (see section 3.3 "Scope of supply").

4.3 Transport

Depending on the chosen version, the cooling unit may weigh up to 73 kg. The components in the cooling unit chassis account for the bulk of the weight.



Warning!

Please note the maximum weights that may be lifted by individuals. It may be necessary to use lifting gear.

At the rear of the cooling unit is a handle which can be used to briefly lift the cooling unit when inserting into the mounting cut-out.

There is also an M12 thread at the top of the chassis, into which a Rittal eyebolt (e.g. belonging to an enclosure) may be screw-fastened. The cooling unit is readily transported with the aid of lifting gear and an indoor crane.



Note:

An eyebolt with M12 thread may be ordered as an accessory from Rittal (see section 13 "Accessories").

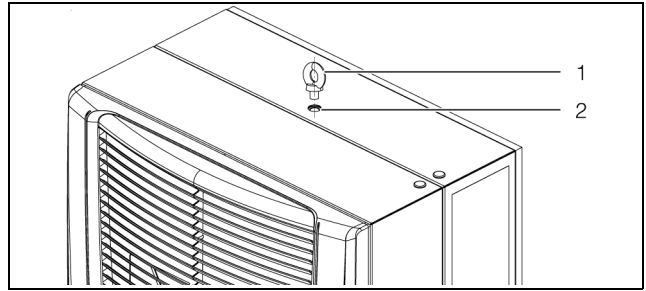

Fig. 3: Thread and eyebolt on top of the chassis

Key

- 1 Eyebolt
- 2 M12 thread

- Before transporting by crane, please ensure that the lifting gear and crane have sufficient load capacity to transport the cooling unit safely.
- Never allow anyone to stand beneath a suspended load, even for a short time, during transportation by crane.
- Protect the lifting gear on the crane hook from load deflection, because the load's centre of gravity may be off-centre.
- First position the cooling unit close to the installation site and protect from accidentally being knocked over.

Transporting a pre-assembled unit

- Shipping braces (such as a structure made from square timbers or boards) must be used when transporting cooling units already mounted on the enclosure. These braces support the cooling unit and prevent it from slipping in case of impact.
- Use a sufficiently large pallet to prevent it tipping over.
- If the cooling unit has been mounted on a door, close the door and keep it closed during transportation.

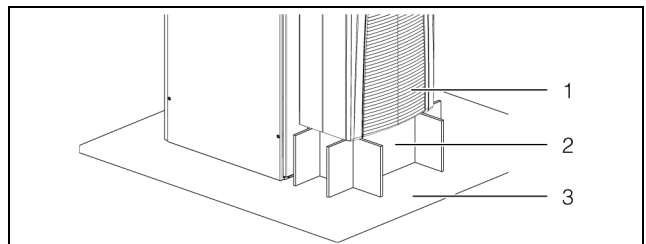

Fig. 4: Shipping braces

Key

- 1 Fitted cooling unit
- 2 Supporting structure
- 3 Pallet underneath the cooling unit

5 Installation

5.1 Safety instructions



Warning!

Please note the maximum weights that may be lifted by individuals. It may be necessary to use lifting gear.



Warning!

Work on electrical systems or equipment may only be carried out by an electrician or by trained personnel under the guidance and supervision of an electrician. All work must be carried out in accordance with electrical engineering regulations.

The cooling unit may only be connected after the aforementioned personnel have read this information!

Use only insulated tools.

Follow the connection regulations of the appropriate electrical supply company.

The cooling unit must be connected to the mains via an all-pole disconnecting device to overvoltage category III (IEC 61058).

The cooling unit is not de-energised until all of the voltage sources have been disconnected!

- Please be sure to observe the applicable regulations governing electrical installations of the country in which the device is installed and operated, as well as national regulations for accident prevention. Please also observe any internal company regulations, such as work, operating and safety regulations.
- The technical specifications and limit values stated must not be exceeded under any circumstances. In particular, this applies to the specified ambient temperature range and IP protection category.

5.2 Siting location requirements

When choosing the installation site for the enclosure, please observe the following:

- The site for the enclosure, and hence the positioning of the cooling unit, must be carefully selected so as to ensure good ventilation (clearance between cooling units and clearance between a cooling unit and the wall must be at least 200 mm in each case).

- The cooling unit must be installed and operated with a maximum deviation of 2° from the vertical.
- The installation site must be free from excessive dirt, aggressive ambient conditions and moisture.
- The ambient temperature must not exceed 60 °C (140 °F).
- It must be possible to fit a condensate water discharge (see section 5.3.8 "Connect the condensate water discharge").
- The mains connection data as stated on the rating plate of the cooling unit must be guaranteed.

Size of installation room

- **Unit SK 3185x3x** must not be installed in rooms of less than 3 m³.
- **Units SK 3186x3x and SK 3187x3x** must not be installed in rooms of less than 6 m³.
- **Units SK 3188x4x and SK 3189x4x** must not be installed in rooms of less than 12 m³.

Electromagnetic interference (EMI)

- Interfering electrical installations (high frequency) must be avoided.
- Signal cables must be laid separately from live cables (fig. 20).

5.3 Assembly procedure

5.3.1 Assembly instructions

- Before assembling, please ensure that the enclosure is sealed on all sides (IP 54). Increased condensation will occur later during operation if the enclosure is not airtight.
- If applicable, additionally fit a door limit switch (such as 4127010) to the enclosure which switches off the cooling unit when the enclosure door is opened to prevent excessive condensation (see section 3.1.8 "Door limit switch").
- Please ensure that the electronic assemblies in the enclosure allow the even circulation of air.

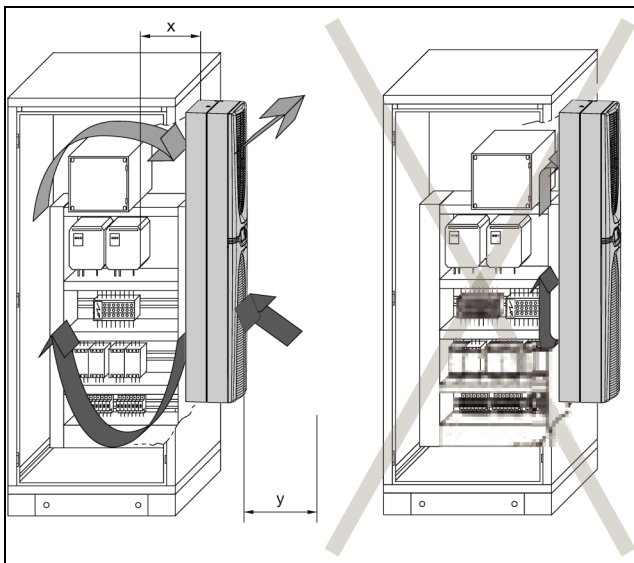

Fig. 5: Air circulation inside the enclosure

Model No.	Dimensions x and y [mm]
SK 3185xxx	195
SK 3186xxx/SK 3187xxx	185
SK 3188xxx/SK 3189xxx	200

Tab. 2: Dimensions "x" and "y"

- Under no circumstances should the air inlet and outlet openings of the cooling unit be obstructed. Only in this way is it possible to ensure that the maximum cooling output is available.
- Please ensure that the cold airflow from the cooling unit is not directed at active components.

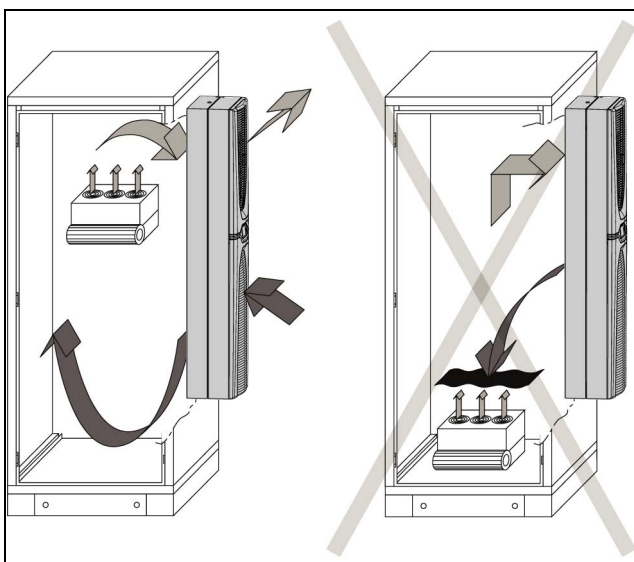

Fig. 6: Never direct the cold airflow at active components (example illustration)

- If appropriate, install components to divert the air.
- When installing in a dismantled door or side panel, please ensure that it cannot fall over when installing the cooling unit in the mounting cut-out.



Note:

The pictures in this chapter illustrate the installation of the cooling unit in an enclosure door. Installation in a side panel is carried out in the same way.

5.3.2 Mounting options

In principle, there are three different options for installing the cooling unit on an enclosure door or side panel.

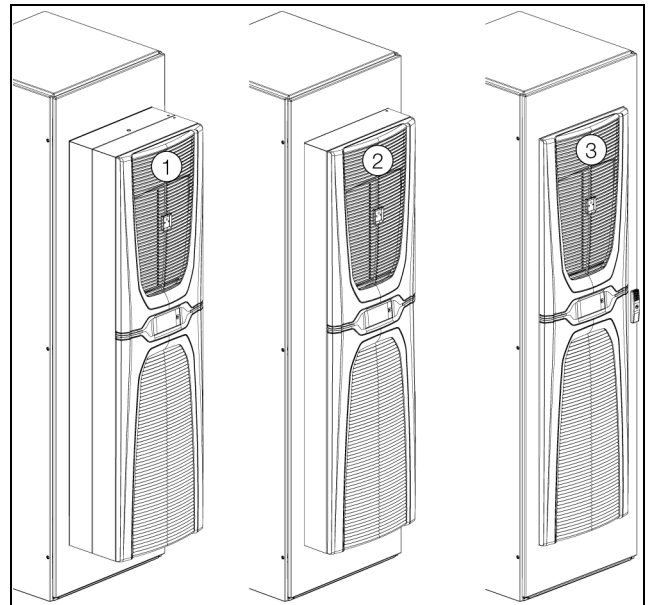

Fig. 7: Mounting options (example illustration)

Key

- 1 External mounting
- 2 Partial internal mounting
- 3 Full internal mounting

- External mounting: All of the cooling unit is outside the enclosure.
- Partial internal mounting: The cooling unit chassis is inside the enclosure, while the cover and the louvred grilles are outside.
- Full internal mounting: All of the cooling unit is inside the enclosure. Only the louvred grilles project on the outside.



Note:

- Full internal mounting of the 4 kW and 6 kW cooling unit is **not** possible.
- For enclosures with 500 mm depth, 2 kW to 6 kW units may only be externally mounted on the side panel.
- For the 1.6 kW unit, all mounting variants are supported, even for enclosures with 500 mm depth.

Your chosen installation option will ultimately depend on how much space you require inside and outside of the enclosure. The various mounting options have no influ-

5 Installation

EN

ence on the cooling output of the cooling unit, which remains the same in all cases.

- If there are a large number of components installed **inside the enclosure**, external mounting or partial internal mounting of the cooling unit may be appropriate. In such cases, the space inside the enclosure may be insufficient for full internal mounting, or it may not be possible to guarantee adequate cooling of all components inside the enclosure.
- If the space **surrounding the enclosure** is limited, full internal mounting may be suitable, so as to keep essential escape routes clear.

5.3.3 Make a mounting cut-out in the enclosure

In order to mount the cooling unit on the enclosure, a suitable mounting cut-out must be made in the door or side panel of the enclosure. In principle, the mounting cut-out is identical for all three mounting options. Only the external mounting of 2 kW to 6 kW units (i.e. all units, except for the 1.6 kW unit 3185x3x) on the side panel of a 500 mm deep enclosure requires a special mounting cut-out.



Note:

The dimensions of the mounting cut-outs can be found in section 12.1 "Representation of mounting cut-outs".

- Using the diagrams in section 12.1 "Representation of mounting cut-outs", calculate the required dimensions for your mounting cut-out.
 - Drill all the required holes and make the mounting cut-out.
 - Carefully deburr all drilled holes and the cut-out to prevent injuries caused by sharp edges.
-



Caution!

Drilled holes and cut-outs that have not been fully deburred may cause cut injuries, particularly when assembling the cooling unit.

5.3.4 External mounting of the cooling unit



Fig. 8: "External mounting, 600 mm" (example illustration)

- Cut the sealing tape in the dispatch bag to the required length so that it can be placed all the way round the rear of the cooling unit once.
- Start by positioning the sealing tape on the bottom edge, so that the joint between the two ends of the sealing tape is likewise on the lower edge of the unit.
- Carefully stick the sealing tape as close to the edge as possible on the rear of the cooling unit.
- Screw the two threaded bolts into the **external** blind threaded bushes at the bottom rear of the cooling unit.
- Push the two locating springs included with the supply into the relevant holes at the top edge of the cooling unit at the rear.

These locating springs will prevent the cooling unit from falling out of the mounting cut-out later on before it is properly secured with the threaded bolt.

- Lift up the cooling unit, preferably with a lifting eye using suitable lifting gear, and initially set the cooling unit down with the two bottom threaded bolts on the door or side panel of the enclosure.
 - If transportation by crane is not possible, lift the cooling unit into the mounting cut-out in the same way using the handle.
 - Push the cooling unit into the mounting cut-out at the top until the locating springs behind the cut-out latch home.
 - Screw the two threaded bolts into the **external** blind threaded bushes at the top rear of the cooling unit.
 - Attach the two corner brackets to the threaded bolts at the top and secure with the corresponding washers and hex nuts (maximum torque: 5 Nm).
 - Next, attach the two corner brackets to the threaded bolts at the bottom and secure with the corresponding washers and hex nuts (maximum torque: 5 Nm).
 - Insert the six spring terminals (or four spring terminals for the 1.6 kW unit 3185x3x) into the rear of the cooling unit.
- These spring terminals ensure that the cooling unit is directly in contact with the mounting cut-out of the enclosure door over the entire height.
- If applicable, re-attach the door or side panel including cooling unit to the enclosure, if not mounted directly on the enclosure.

5 Installation

EN

5.3.5 Mounting the cooling unit externally on a 500 mm deep enclosure



Note:

The description in this section applies to the external mounting of 2 kW to 6 kW cooling units on the side panel of a 500 mm deep enclosure. External mounting on deeper enclosures is also possible with this mounting method.

For the 1.6 kW unit, external mounting on a 500 mm deep enclosure uses the same mounting cut-out as a wider enclosure (see section 5.3.4 "External mounting of the cooling unit").

- Push the cooling unit into the mounting cut-out at the top until the locating springs behind the cut-out latch home.
- Attach the two corner brackets to the threaded bolts at the top and secure with the corresponding washers and hex nuts (maximum torque: 5 Nm).
- Secure the remaining threaded bolts at the bottom with the corresponding washers and hex nuts (maximum torque: 5 Nm).
-



Fig. 9: "External mounting, 500 mm"

- Cut the sealing tape in the dispatch bag to the required length so that it can be placed all the way round the rear of the cooling unit once.
- Start by positioning the sealing tape on the bottom edge, so that the joint between the two ends of the sealing tape is likewise on the lower edge of the unit.
- Carefully stick the sealing tape as close to the edge as possible on the rear of the cooling unit.
- Push the two locating springs included with the supply into the relevant holes at the top edge of the cooling unit at the rear.
These locating springs will prevent the cooling unit from falling out of the mounting cut-out later on before it is properly secured with the threaded bolt.
- First, screw the two threaded bolts into the **internal** blind threaded bushes at the top rear of the cooling unit.
- Then, screw the two threaded bolts into the blind threaded bushes half-way up the rear of the cooling unit.
- Finally, screw the two threaded bolts into the **internal** blind threaded bushes at the bottom rear of the cooling unit.
- Lift up the cooling unit, preferably with a lifting eye using suitable lifting gear, and set it down with the threaded bolts in the relevant holes of the enclosure.

5.3.6 Partial internal mounting of the cooling unit



Fig. 10: "Partial internal mounting" (example illustration)

- At the front of the cooling unit, pull the top louvred grille away from the mounting clips on the cover, and place or lay it down somewhere safe.
- Flip open the bottom louvred grille below the infill panel.
- Release the two stays in the hinge mechanism at the top from the brackets attached to the cover of the cooling unit.
- Pull the bottom louvred grille forwards out of its holders, and place or lay it down somewhere safe.
- Gently pull the infill panel including display forwards to release it from the mounting clips on the cover.
- On the rear of the display, disconnect both of the connectors (PE conductor and connection) and remove the infill panel completely from the cooling unit.
- Place the infill panel somewhere safe.
- Carefully push the connector including connection cable inwards through the cable gland in the cover.



Caution!

The cooling unit will only be stable as long as the cover and chassis are connected. For this reason, be sure to brace the chassis, in particular, to prevent it from falling over before removing the cover.

- Loosen the four threaded bolts in the corners of the cover which connect the cover to the chassis.
- Carefully pull the cover forwards (approx. 5 cm) from the chassis.
The PE conductor connection between the cover and the chassis is located on the left-hand side, around half-way up.
- Pull the flat-pin connector of the PE conductor off inwards, preferable on the chassis.
- Remove the cover completely from the chassis, and place or lay it down somewhere safe.
There is a clip prefitted to the top edge of the chassis on the front. This clip will later prevent the chassis from falling out of the mounting cut-out before it is properly secured with the threaded bolt.

- Lift up the chassis, preferably with a lifting eye using suitable lifting gear, and insert it into the mounting cut-out in the door or side panel of the enclosure from the inside with the edge fold at the bottom of the chassis.
- If transportation by crane is not possible, lift the chassis into the mounting cut-out in the same way using the handle.
- Push the chassis into the mounting cut-out at the top until the clip behind the cut-out latches home.
- Make sure that the clip behind the cut-out is fully snapped in towards the top.
- Please also insert the wedge element from the exterior up to the stop in order to fasten the clip in the upper position.
- Set the cover down at the front near the chassis.
- Slide the flat-pin connector of the PE conductor into place, and ensure that the cover and chassis are connected.



Warning!

The PE conductor which connects the cover and the chassis must be connected to both connectors in all cases. Otherwise, there is a risk of injury from electric shock if the unit connection was faulty or defective.

- Place the cover fully over the chassis, and connect the cover and the chassis using the four threaded bolts in the corners of the cover.
- Tighten the four threaded bolts in the corners of the cover to reconnect the cover with the punched section (maximum torque: 4 Nm).
- Thread the connection cables of the display outwards through the cable gland in the cover.
- Connect the PE conductor and connector at the rear of the display.
- Install the complete infill panel on the cooling unit.
- Place the bottom louvred grille onto the holders and secure the two stays at the top of the hinge mechanism into the brackets attached to the cover of the cooling unit.
- Finally, replace the top louvred grille onto the cover.
- If applicable, re-attach the door or side panel including cooling unit to the enclosure, if not assembled directly on the enclosure.

5 Installation

EN

5.3.7 Full internal mounting of the cooling unit



Fig. 11: "Full internal mounting" (example illustration)

- First, dismantle the top and bottom louvred grilles as well as the infill panel and the display in the same way as for partial internal mounting (see section 5.3.6 "Partial internal mounting of the cooling unit").
- Cut the sealing tape in the dispatch bag to the required length so that it can be placed all the way round the cover once.
- Start sticking the sealing tape at the bottom edge, so that the joint between the two ends of the sealing tape is likewise on the bottom edge of the unit.
- Carefully stick the sealing tape as close as possible to the edge of the cover.
- On the front top edge of the cover, push the locating springs included with the supply into the relevant holes.
These locating springs will prevent the cooling unit from falling out of the mounting cut-out later on before it is properly secured with the threaded bolt.
- Lift up the cooling unit, preferably with a lifting eye using suitable lifting gear.
- If transportation by crane is not possible, lift the cooling unit into the mounting cut-out in the same way using the handle.
- Position it in the mounting cut-out in the door or side panel of the enclosure with the two brackets at the bottom of the cover.
- Push the cooling unit into the mounting cut-out at the top until the locating springs behind the cut-out latch home.
- Mount the corner brackets onto the top two threaded bolts from the outside.
- Mount the L-shaped brackets onto the bottom two threaded bolts from the outside.
- Next, working from the outside of the enclosure, secure the four threaded bolts in the corners of the cover using the corresponding washers and hex nuts from the pack (maximum torque: 5 Nm).
- Insert the six spring terminals (or two spring terminals for the 1.6 kW unit 3185x3x) into the cover of the cooling unit.
These spring terminals ensure that the cooling unit is directly in contact with the mounting cut-out of the enclosure door over the entire height.

- Connect the PE conductor and connector at the rear of the display.
- Install the complete infill panel on the cooling unit.
- Place the bottom louvred grilles onto the holders and secure the two stays of the top hinge mechanism into the brackets attached to the cooling unit cover.
- Finally, replace the top louvred grille onto the cover.
- If applicable, re-attach the door or side panel including cooling unit to the enclosure if not mounting directly on the enclosure.

5.3.8 Connect the condensate water discharge

There is a condensate water evaporator fitted in the external circuit of the cooling unit. With an enclosure connected, this condensate water evaporator may typically evaporate condensate water volumes of up to 100 ml/h. If larger quantities of condensate water are produced, a condensate water discharge hose may additionally be fitted. This hose allows condensate water to be routed out of the cooling unit pressurelessly. A suitable hose is available as an accessory from Rittal (see section 13 "Accessories").

Please follow the instructions given below:

- The hose must be laid with an adequate and constant gradient to prevent siphoning.
- The hose must be laid without any kinks.
- If extended, the cross-section of the hose must not be reduced.
- The hose should be routed to a drain or external condensate water evaporator by the customer.

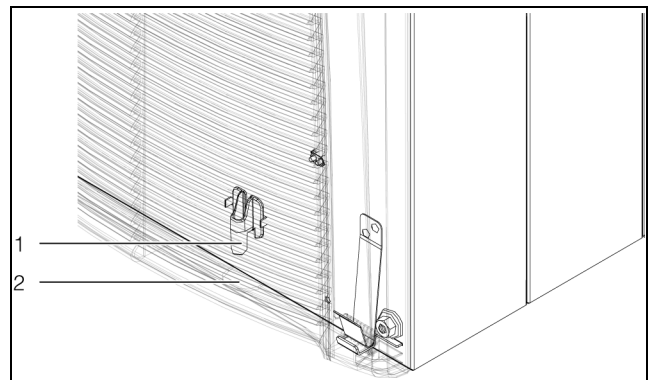

Fig. 12: Connection for condensate water discharge hose

Key

- 1 Connection point
- 2 Hole in enclosure for hose

- Connect a suitable hose to the condensate water discharge nozzle and secure using a hose clip.
- Lay the hose as per the instructions above.

5.4 Electrical connection

5.4.1 Notes on electrical installation

- When carrying out the electrical installation, it is important to observe all valid national and regional regula-

tions as well as the provisions of the responsible power supply company.

- Electrical installation must only be carried out by a qualified electrician who is responsible for compliance with the existing standards and regulations.
- All cables routed into the wiring compartment have to be insulated for the maximum voltage of the power supply.

Connection data

- The connected voltage and frequency must correspond to the ranges stated on the rating plate. The units support multiple voltages.
- The cooling unit must be connected to the mains via an all-pole disconnect to overvoltage category III (IEC 61058-1).
- The unit is intrinsically safe and does not require any additional external safety devices for safe operation.
- The connection cable must be protected with a miniature circuit-breaker.
- No additional temperature control may be connected upstream of the unit at the supply end
- To ensure the proper functioning of internal pressostats in the event of a malfunction, a line fuse of no less than 15 A is required.
- If a motor circuit-breaker or circuit-breaker is used, it should be selected in accordance with EN 60898-1 (tripping characteristic type D).
- For applications in UL-approved facilities, any CCMR-type fuse from Littelfuse may be used, or alternatively, a UL-certified air circuit-breaker.
- Suitable miniature circuit-breakers and circuit-breakers can be found under Rittal accessories (see section 10 "Technical specifications" and section 13 "Accessories").
- Thanks to the integral inverter technology, conventional start-up currents (start-up of internal motors) are not externally visible.
- The mains infeed and the signal cable may optionally be of a shielded design.
- Low-noise potential equalisation must be guaranteed with the mains connection.

Overvoltage protection and supply line load

Rittal recommends the following measures for protecting the cooling units in non-standard environmental and connection conditions.

- The unit does not have its own overvoltage protection. Measures must be taken at the supply end by the switchgear manufacturer or operator to ensure effective protection against lightning and overvoltage.
- The units are classified as overvoltage category III and meet the requirements of EN 60204-1 on the electrical equipment of machines. The mains voltage must not deviate by more than the tolerance specified in section 10 "Technical specifications".
- The discharge current may exceed 3.5 mA.

- The units are high-voltage tested ex works. An additional high voltage test must only be carried out with a DC voltage supply source (1500 VDC max.).
- EMC interference signals arising in local industry and plant networks may deviate significantly from those specified in the standards. In these types of network situations, an external EMC filter should be used.
- If the combined output of the frequency converters, power converters or transformers in the network where the device is being operated is >70 kVA, the customer must connect a Class II surge voltage protector in the mains supply line upstream of the cooling unit. The surge voltage protector must be designed to EN 61800 -1. The following values may be assumed as starting-points for the design:

Transformers, power electronics	Assumed discharge energy
70 kVA...100 kVA	40 J
100 kVA...200 kVA	80 J
200 kVA...400 kVA	160 J
400 kVA...800 kVA	320 J

Tab. 3: Design of the surge voltage protector

Technical specifications for a suitable overvoltage protection module:

- Terminal voltage $U_c = 350 \dots 400 \text{ V}$, 50/60 Hz
- Maximum current $I_{max} = 40 \text{ kA}$
- Rated current $I_n = 20 \text{ kA}$
- Breakdown voltage $U_p = 1.75 \text{ kV}$

Three-phase devices

- There is no need to observe a counterclockwise or clockwise phase rotation when making the electrical connection for inverter devices in the three-phase version. The electronics incorporated into the devices automatically create the required phase rotation.
- In three-phase devices, the absence of a phase is detected, and the device is switched off.
- Outgoing equipment is monitored by the inverter, and deactivated in the event of a malfunction in the electricity supply.

Door limit switch

- Each door limit switch can only be assigned to one cooling unit.
- Several door limit switches may be operated in parallel with one cooling unit.
- The minimum cross-section for the connection cable is 0.3 mm^2 for a cable length of 2 m.
- The line resistance to the door limit switch must not exceed a maximum of 50Ω .
- The maximum admissible line length is 10 m.

5 Installation

EN

- The door limit switch only supports a floating connection; no external voltages.
- The contact of the door limit switch must be closed when the door is open.
- The safety extra-low voltage for the door limit switch is provided by the internal power pack: Current approx. 5 mA DC.
- Connect the door limit switch to terminals 5 and 6 of the signal connector.

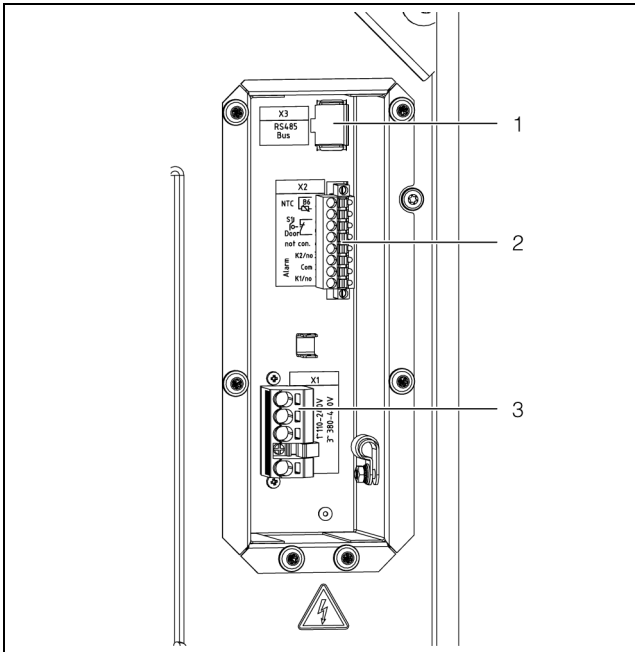

Fig. 13: Connections at rear (example illustration)

Key

- 1 Connection for IoT interface 3124300 (X3)
- 2 Connection for signal connector (X2)
- 3 Connection for mains connector (X1)

Installing the ferrite core

- Attach the ferrite core from the scope of delivery to the signal cables near the connection plug to prevent interference in the signal transmission.

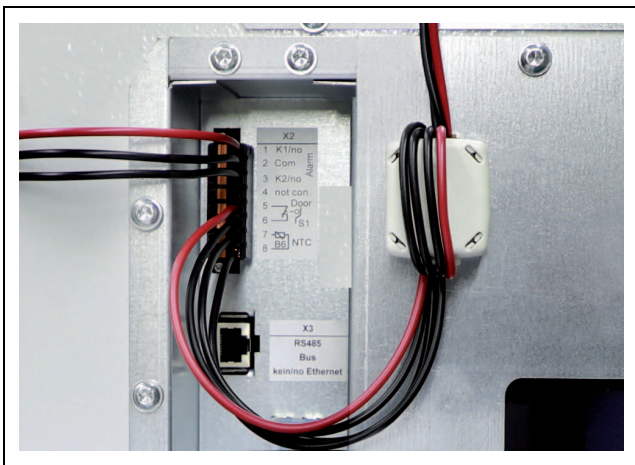

Fig. 14: Signal cable with mounted ferrite core

Potential equalisation

If, for EMC reasons, the unit is to be integrated into the customer's existing potential equalisation system, a conductor may be connected to the potential equalisation connection point. The connection point is labelled with the required switch symbol.

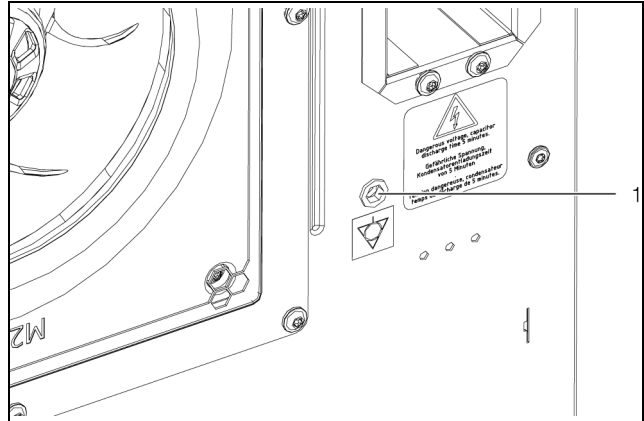

Fig. 15: Connection point for potential equalisation (example illustration)

Key

- 1 Connection point M6

- Attach the potential equalisation to the unit's connection point using the screw, washer and contact washer.

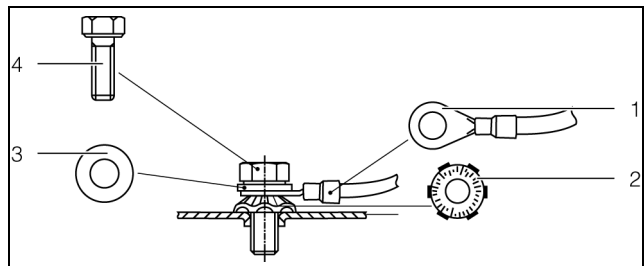

Fig. 16: Potential equalisation arrangement

Key

- 1 Ring terminal with PE conductor
- 2 Contact washer
- 3 Washer
- 4 Screw



Note:

According to the standard, the PE conductor in the mains connection cable is not classed as an equipotential bonding conductor.

5.4.2 Install the power supply



Note:

- We recommend that the power supply cable and the signal cable should be of a shielded design.
- The cable shield can make contact with the T-rail (fig. 19).
- The PE conductor must be connected

- Remove the mains connector from the dispatch bag and connect to the mains as shown on the connection diagram (fig. 17 or fig. 18).

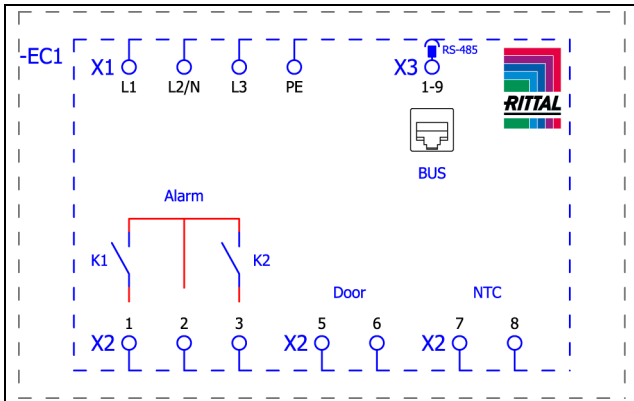

Fig. 17: Circuit diagram SK 3186x3x, SK 3187x3x and SK 3185x3x

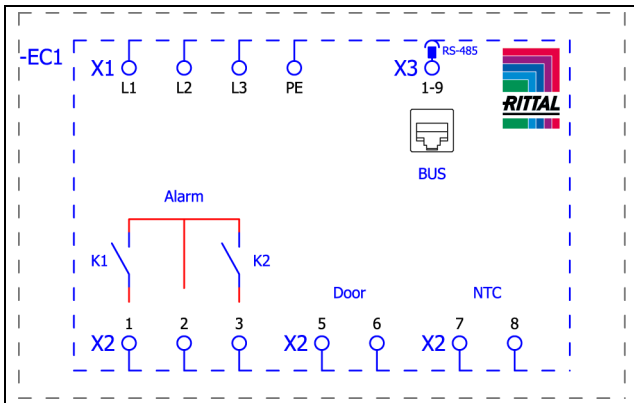

Fig. 18: Circuit diagram SK 3188x4x and SK 3189x4x

Key

- X1 Main terminal strip
- K1 Relay collective fault 1
- K2 Relay collective fault 2
- Door Door limit switch (optional, without door limit switch: terminal 5, 6 open)
- NTC External temperature sensor (optional)
- X3 RS 485 interface

Create a strain relief

- Remove the T-rail from the pack and attach it to the connection unit.



Fig. 19: Attach the T-rail (example illustration)

- Then create the strain relief.



Fig. 20: Create the strain relief using cable ties (example illustration)

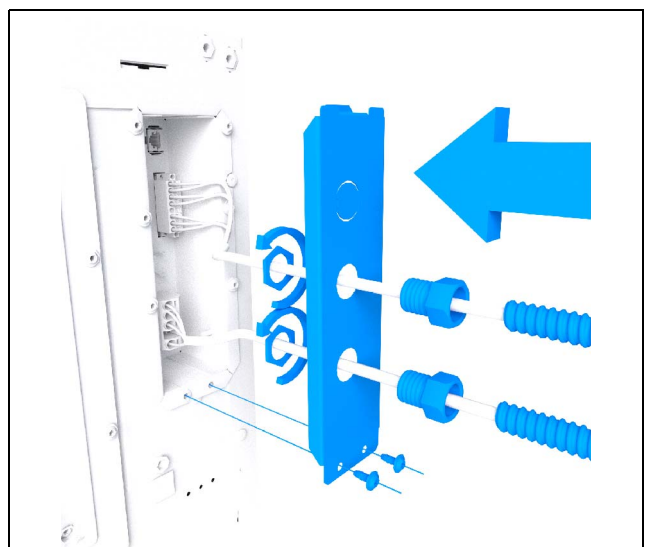

Fig. 21: Cover for the connection unit and conduit fitting (example illustration)

5 Installation

EN



Note:

Optionally, the cover from the Rittal accessories (see section 13 "Accessories") can be fitted over the electrical connection as protection. It must always be used in IT and container applications.

- Use copper conductors only to connect the supply cable to the mains connector.

5.4.3 Connect the alarm relays

System messages from the cooling unit may be output to an external signal source via two floating relay outputs.



Note:

The factory setting of the relay outputs in their de-energised state is NO (Normally Open).

- Connect a suitable connection cable to the connection terminals 1 (Alarm K1) and/or 3 (Alarm K2) of the signal connector (X2).
- Configure the alarm relays you wish to use to output error messages (see section 7.5.3 "Alarm relays").

AC
cos ϕ = 1

I max. = 2 A
U max. = 250 V

Tab. 4: Contact data

5.4.4 Interfaces

The cooling unit has the following interfaces for communicating with external systems:

- Micro-USB interface on the front
- RS 485 interface on the rear
- NFC interface

Micro-USB interface

A micro-USB interface is located on the front, to the right of the display. A laptop may be connected here to update the device (see section 7.2 "Updater program"). No other USB devices will be detected on this connection.

RS 485 interface

An RS 485 interface is located on the rear of the connection box. The IoT interface for linking the cooling unit to the customer's own monitoring, energy management and/or superordinate systems may be connected here.

- Connect the IoT interface (accessory) to the RS 485 interface (X3).



Note:

A direct connection to the cooling unit via the RS 485 interface is not possible.

NFC interface

The cooling unit may be accessed with a smartphone app via the integral NFC interface. Access is only possible with the app supplied by Rittal (see section 13 "Accessories").

6 Commissioning



Note:

The oil must collect in the compressor in order to ensure adequate lubrication and cooling. For this reason, do not operate the cooling unit for at least 30 minutes after assembling the equipment.

- Observe the aforementioned waiting period of at least 30 minutes before commissioning the unit after assembly.
 - Next, switch on the voltage supply to the cooling unit. The Rittal logo will initially appear on the display, followed a short time later by the start screen.
 - You can now make your individual settings on the unit, e.g. set the temperature or assign the network identifier, etc. (refer to chapter 7 "Operation").
-



Note:

It is **not** necessary to carry out leak or pressure tests on the cooling unit prior to commissioning. Rittal has already done this in the factory.

7 Operation

EN

7 Operation

7.1 General

The cooling unit is equipped with a touch function display for making basic settings and displaying error messages. This is an industrial-grade touch display which is pressure-sensitive and may therefore be operated with gloves.

As well as operating directly on the cooling unit itself, there is also a smartphone app available. This offers almost the same functions as the actual display, and additionally provides extended explanations of error messages, as well as the option of contacting the Rittal Service team directly.

7.2 Updater program

Software updates can be carried out using the Updater program. The USB interface on the front of the cooling unit serves as an interface.

The Updater program can be found in the Downloads section of the product website.

7.3 Layout of the display

The display is divided into a top section on a dark background, and a bottom section with the menu bar. This layout is always identical, but the content of the two sections will vary according to the menu selected.

7.3.1 Start screen

The start screen is always displayed while the cooling unit is in normal operation, provided there are no error messages.



Fig. 22: Layout of the start screen

Key

Item	Description	Possible icons
1	Internal temperature display (2-digit °C/3-digit °F)	Numbers from 0-9
2	EER scale: Range 0...20 / current average EER value of the last 24 hours	EER

Tab. 5: List of all icons with descriptions

Item	Description	Possible icons
3	Ti scale: Range 20 ...60 / value: Average enclosure internal temperature of the last 24 hours	
4	Display temperature unit	°C °F
5	USB connection (if connected)	
6	Self-test (if initiated)	
7	NFC connection (max. 120 seconds after connecting)	
8	Type of cooling	
9	Control based on ...	
10	External sensor	
11	Information menu	
12	System messages (where applicable)	
13	Service icon (if required)	
14	Configuration	

Tab. 5: List of all icons with descriptions

Type of cooling

The current form of cooling is indicated by one of the following four icons.

Symbol	Parameters
	Cooling in compressor mode without support from the heat pipe
	Cooling in compressor mode with support from the heat pipe
	Cooling via the heat pipe only
	No cooling

Tab. 6: Possible icons for the current type of cooling

7.3.2 Changing a parameter value

If a parameter value is changed, the display including the menu bar will also change.



Fig. 23: Screen for changing a parameter value

Key



- 1 Main screen
- 2 Control bar

The currently selected parameter value is displayed in the centre of the main screen. To change this value, you always proceed in the same way, as described below with the example of adjusting the set temperature:

- On the start screen, click on the "Configuration" button.
- Enter the PIN to gain access to the lower-level screen pages of the "Configuration" zone. "22" is the default PIN.
- Click on the "Temperature" symbol.
- Click on the "Control mode" symbol.
- Select your preferred control mode from the display.
- Change the setting to the required temperature using the "Up" and "Down" arrows.
- Alternatively, you can also select the one of the displayed higher or lower values directly.
- Finally, confirm the set value with "OK".
- Exit this screen page with the "Back" button.

7.4 Information menu



- Click on the "Information" symbol to display a list of lower-level screen pages.

Symbol	Parameters
	Temperature info
	Device info
	Efficiency info

Tab. 7: "Information" zone

7.4.1 Temperature information









- Click on the "Temperature information" symbol. The ambient temperature and internal temperature are displayed, in each case as an average for the last 24 hours of operation.

Symbol	Parameter
	ØTU 24h Average ambient temperature (external temperature) over the last 24 hours of operation.
	ØTI 24h Average internal temperature over the last 24 hours of operation.

Tab. 8: "Temperature information" zone

7.4.2 Device information

- Click on the "Device information" symbol. A list of general information about the device will be displayed.
- Page through the list using the "Up" and "Down" arrows.

Symbol	Parameter
	Serial number
	Manufacture date YYYY-MM-DD
	Hardware Release x.xx.xx
	Firmware Release x.xx.xx
	Software Release x.xx.xx
	Last update YYYY-MM-DD
	Last maintenance YYYY-MM-DD
	User device name Name assigned to the cooling unit by the customer. The name can be assigned via the "Rittal Scan & Service" app to distinguish between individual devices.
	Act. control mode

Tab. 9: "Device information" zone

7 Operation

EN

Symbol	Parameter
	If the unit is configured as a "slave": Slave number.

Tab. 9: "Device information" zone

7.4.3 Efficiency information

- Click on the "Efficiency information" symbol.

The average energy efficiency ratio (EER) for the last 24 hours of operation will be displayed. The energy efficiency ratio is the ratio of the cooling output generated to the electrical power used.

Symbol	Parameter
EER	Average EER 24h Average energy efficiency ratio (EER) of the last 24 hours of operation.

Tab. 10: "Efficiency information" zone

7.5 Configuration menu

- Click on the "Configuration" symbol.





A screen page will appear asking you to enter the PIN in order to access the lower-level screen pages.





Note:
"22" is preset in the factory as the default PIN.

- For the first digit, page through the digits "0" to "9" using the "Up" and "Down" arrows until the required digit appears in the box.
- Confirm your selection with "OK".
- For the second digit, once again page through the digits "0" to "9" using the "Up" and "Down" arrows until the required digit appears in the box.
- Confirm your selection with "OK".

A list of lower-level screen pages will be displayed.

Symbol	Parameter
	Temperature Settings for set temperature and control mode
	Network Display of network information from the IoT interface (3124300)
	Alarm relay Settings for the alarm relays.
	Filter mats



Tab. 11: "Configuration" zone

Symbol	Parameter
	Display language Choice of language for display texts.
	Self-test Perform a self-test.

Tab. 11: "Configuration" zone

7.5.1 Temperature

- Click on the "Temperature" symbol to display a list of lower-level screen pages.

Symbol	Parameter
	Change unit Set the unit "°C" or "°F"
	Control mode
	Alarm threshold Temperature limit which will trigger an alarm message if exceeded.

Tab. 12: "Temperature" zone

Change unit

All temperature values for the unit may be displayed either in degrees Celsius "°C" or degrees Fahrenheit "°F".

- Click on the "Change unit" symbol.
- Change the required unit ("°C" or "°F") using the "Up" or "Down" arrows.
- Confirm your entry with "OK".

Control mode

The cooling unit controls cooling output according to one of the following three temperature values:

- Inside temp.:** The temperature at which air is drawn out of the enclosure into the cooling unit.
- External sensor:** The temperature measured with an external temperature sensor at a so-called hot spot in the enclosure.
- Outlet temp.:** The temperature measured with an external temperature sensor at the cold air outlet from the cooling unit.

Control mode "external sensor"

Please observe the following when selecting the sensor position: The sensor must **not**

- be influenced directly by the cold air expelled from the cooling unit,
- be influenced by external heat sources or heat radiation,
- be exposed to humidity,

- have its connection cable laid in the vicinity of AC cables,
- be exposed to different temperature levels within the first 10 cm of the connection cable.

The sensor *must*

- be located within the effective range of the cooling unit,
- be surrounded by adequate moving air which has blended well with the air expelled by the cooling unit,
- be at an adequate distance from solid and liquid substances.

Control mode "outlet temperature"

- Attach the temperature sensor in front of the cold air outlet from the cooling unit, in the centre (fig. 24).

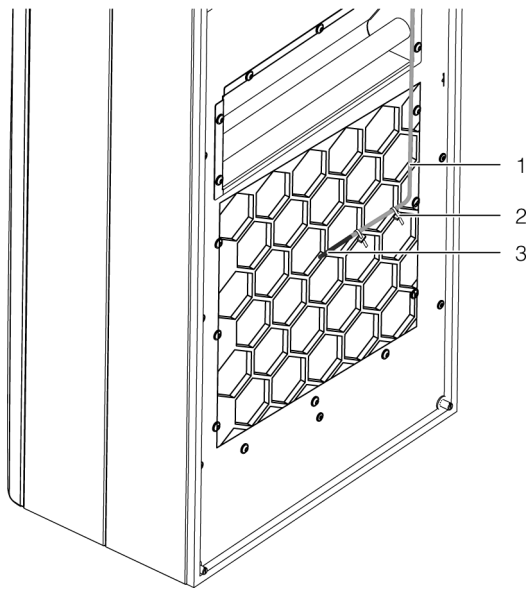

Fig. 24: Temperature sensor in front of cold air outlet (example illustration)

Key

- 1 Sensor cable
- 2 Cable ties (2x)
- 3 Sensor element



Note:
The sensor element must not be in contact with the enclosure.



Note:
To ensure the accuracy of the outlet temperature, at least 50% of the total cooling output should be installed as heat loss. The output can be taken from the characteristic curve for this unit.

Selecting a control mode

- Click on the "Control mode" symbol.

The setpoint for the currently set control mode is displayed.

- Choose your preferred control mode by selecting it from the display:

Symbol	Parameter	Setpoint	Factory setting
	Internal temperature	20 °C (68 °F) ... 50 °C (122 °F)	35 °C (95 °F)
	External sensor		
	Outlet temperature	18 °C (64 °F) ... 28 °C (82 °F)	24 °C (75 °F)

Tab. 13: "Control mode" zone

The corresponding symbol for the chosen control mode is likewise displayed on the overview page.



Note:
The external temperature sensor is available as accessory from Rittal (see section 13 "Accessories").

- Change the setpoint using the "Up" and "Down" arrows or select the required temperature directly.
- Confirm your entry with "OK".

Alarm threshold

This limit is used for an alarm message. The set value must therefore be above the actual setpoint to which the cooling unit has been set.

For example:

- Setpoint: 35 °C (95 °F)
- Alarm limit min.: 38 °C (100 °F)
- Alarm limit max.: 50 °C (122 °F)

Symbol	Parameter	Alarm limit	Factory setting
	Internal temperature	Setpoint + 3 °C (5 °F) ... Setpoint + 15 °C (27 °F)	Setpoint + 5 °C (9 °F)
	External sensor		
	Outlet temperature	Setpoint + 12 °C (21 °F) ... Setpoint + 24 °C (40 °F)	Setpoint + 14 °C (25 °F)

Tab. 14: Alarm limit

- Click on the "Alarm limit" symbol.

7 Operation

- Change the setpoint using the "Up" and "Down" arrows or select the required temperature directly.
- Confirm your entry with "OK".



Note:
In "external sensor" and "outlet temperature" control mode, the cooling unit additionally monitors the temperature of the air as it is drawn in. If the set alarm limit seems likely to be exceeded (e.g. due to a rise in heat loss), the cooling output is increased for the duration of the threatened overtemperature, and the setpoint is undercut.

The absolute temperature at which the "Overtemperature" alarm message is output is therefore calculated as follows:

– Limit temperature = Setpoint + alarm threshold

Example of "outlet temperature" control mode:

- Setpoint: 24 °C/75 °F
- Alarm limit: 38 °C/100 °F

Current situation:

- Temperature of air intake: 37 °C/98.6 °F (< alarm limit)
- Temperature of expelled air: 24 °C/75.2 °F (= setpoint)

If the alarm limit is exceeded:

- Temperature of air intake: 39 °C//102.2 °F (> alarm limit)
- Temperature of expelled air: 22 °C/71.6 °F (< setpoint)

If the alarm limit is subsequently undercut due to an increase in the cooling output:

- Temperature of air intake: 37 °C/98.6 °F (< alarm limit)
- Temperature of expelled air: 24 °C/75.2 °F (= setpoint)

7.5.2 Network

- Click on the "Network" symbol to display a list of lower-level screen pages.

Symbol	Parameter
	Network on/off
	Network info

Tab. 15: "Network" zone

Network on/off

Here, you can activate / deactivate data communication to the IoT interface. Data communication is activated by default.

- Click on the "Network on/off" symbol.

- Select your preferred setting by selecting it from the display.
- Confirm your entry with "OK".

Symbol	Parameter
	Network off
	Network on

Tab. 16: Data communication settings

Network info

Get IP information about how the IoT interface is incorporated into the network.

- Click on the "Network info" symbol to display a list of lower-level screen pages.

Symbol	Parameter
	IPv4
	IPv6

Tab. 17: Select the protocol version

IPv4

- Click on the "IPv4" symbol.
A list of general information about the IPv4 settings will be displayed.
- Page through the list using the "Up" and "Down" arrows.

Parameter	Setting
DHCP	off/on
IP address	xxx.xxx.xxx.xxx
Network mask	xxx.xxx.xxx.xxx
Router address	xxx.xxx.xxx.xxx

Tab. 18: IPv4 settings

IPv6

- Click on the "IPv6" symbol.
A list of general information about the IPv6 settings will be displayed.
- Page through the list using the "Up" and "Down" arrows.
- Click on the desired entries to display the IPv6 addresses.



Parameter	Setting
DHCP	off/on
IP address 1	...
IP address 2	...
Auto address	...
Link-local addr.	...

Tab. 19: IPv6 settings

7.5.3 Alarm relays

There are two floating relay outputs in the connection box on the rear of the unit, which may be used to output system messages from the cooling unit to an external signal source (see section 5.4.3 "Connect the alarm relays"). The relay outputs may be configured here.

- Click on the "Alarm relay" symbol to display a list of lower-level screen pages.

Symbol	Parameter
	Switch NO/NC Switch the alarm relay as a normally closed or normally open contact.
	Function list Allocation of a function to the respective alarm relay.

Tab. 20: "Alarm relay" zone





Note:

For the factory setting of alarm relay allocation see section 7.7 "List of system messages" (Tab. 24).

Switch NO/NC

The switch logic of the relay output, i.e. whether it is to be used as a normally closed or normally open contact, may be set here.

- Click on the "Switch NO/NC" symbol.
- Choose your preferred switch logic by selecting it from the display.
- Confirm your entry with "OK".

Symbol	Parameters
	Normally open Switch the alarm relay as a normally open contact.
	Normally closed Switch the alarm relay as a normally closed contact.

Tab. 21: Switch logic of the alarm relay





Note:

The factory setting of the relay output in its connected operating state is "closed".

List of functions

This is where you specify which error messages should lead to switching of the respective relay output.



- Click on the "Relay 1" or "Relay 2" symbol, and select the alarm relay to which you wish to assign a function.
- From the list of errors, select the function which should cause the previously selected relay output to switch.
- If applicable, assign further functions to the relay output, and the output will then be switch if **at least one** of the assigned functions leads to an error message.
- Confirm your entry with "OK".
- If applicable, configure the other relay output with other functions.

Symbol	Parameter
	Assign relay 1
	Assign relay 2

Tab. 22: List of functions

7.5.4 Filter mats

- Click on the "Filter mat" symbol to display a list of lower-level screen pages.

Symbol	Parameter
	Filter reference
	Alarm tolerance

Tab. 23: "Filter mat" zone

Filter reference

Here the device may be set permanently to operation with filter mats.

- Click on the "Filter reference" symbol.
- Click on the "New filter mat" symbol.
- Confirm your entry with "OK".

If the device has already been set to operation with filter mats, by clicking on the menu point "New filter mat", the adjacent system message "Change filter mat" may be reset.



Note:

This message is also reset automatically as soon as the device identifies an improved air throughput in the external circuit thanks to the use of a new filter mat. Assessment of the air throughput only occurs when using the compression system at constant speed, and takes a few minutes.

Alarm tolerance

Here, the alarm tolerance may be set to one of five levels, or filter mat monitoring deactivated. If the set alarm tolerance is exceeded, the system message "Change filter" appears in the display.

Example:

- Setpoint: 35 °C (95 °F)
- External temperature: 20 °C (68 °F)

If an alarm tolerance level of "medium" is selected, the system will tolerate an impairment to the air throughput in the external circuit of approximately 35% before the system message "Change filter" appears in the display.

- Click on the "Alarm tolerance" symbol.
- Change the alarm tolerance ("very small" – "very large"), or deactivate filter monitoring using the "Up" or "Down" arrows.
- Alternatively, select the required level directly (factory setting: "Medium" level).
- Confirm your entry with "OK".



Note:

The more the air throughput in the external circuit is impaired, the lower the maximum cooling output and energy efficiency of the cooling unit will be.

The following diagram illustrates the development of cooling output depending on the air throughput in the external circuit and the alarm limit (fig. 25).

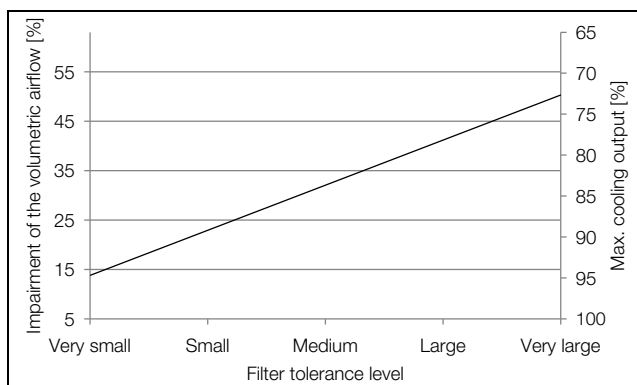

Fig. 25: Sample cooling output development



Note:

- If filter mat monitoring is deactivated ("Deactivate" level), it is still possible to select a filter tolerance level. If the limit is exceeded, the system message "Clean condenser" appears in the display instead of "Change filter".
- If filter mat monitoring is deactivated and no filter tolerance level is selected, no system message will be output.

7.5.5 Language settings

All displays on the unit are available in 21 different languages.

- Click on the "Display language" symbol.
- Page through to the required language using the "Up" and "Down" arrows.
- Confirm the chosen language with "OK".

The language will change over immediately, and all menu displays will appear in the chosen language.

7.5.6 Self-test

In the event of a malfunction in the unit which fails to produce an error message, it may be useful to check the key functions of all components with a self-test. You may continue to operate the unit as normal while the self-test is being carried out.

- Click on the "Self-test" symbol.
- Confirm the start of the self-test with "OK".

While the self-test is being carried out, a progress indicator will appear on the display. Once the test is complete, either the message "Unit OK" or "Check error" will be displayed.

- If applicable, use the error list to determine which malfunction applies.

7.6 System messages

We distinguish between three different types of system messages on the unit:

- Malfunctions
- Errors
- Servicing

If a corresponding message applies, the "System messages" symbol is displayed in the menu bar (fig. 22, item 13). A list of all possible system messages may be found in section 7.7 "List of system messages".

- Click on the "System messages" symbol.

A list of all active system messages will be displayed. The individual messages are arranged in ascending order as they occur according to the above three categories.

If an error message can only be resolved by the Rittal Service team, the "Service" symbol will additionally appear after the error message.

- In such cases, please contact Rittal Service (see section 14 "Customer service addresses").

7.6.1 Occurrence of a malfunction

In the event of a malfunction, the start screen will be superimposed with an error message.



Fig. 26: Screen in the event of a malfunction

Key

- 1 Superimposed
- 2 Menu bar in red

The start screen is superimposed with a message in the following three cases:

1. There is a malfunction on the unit itself.
2. There is a malfunction on one of the units in the master-slave combination.
3. The enclosure door is open and a connected door contact is emitting a corresponding message.

If the malfunctions cannot be resolved by the operator himself, the Service symbol will additionally be displayed (fig. 22, item 14).

- Contact the Rittal Service team if you are unable to resolve the malfunction yourself (see section 14 "Customer service addresses").

7.6.2 Display in case of errors

If errors have occurred or servicing is required, the "System messages" symbol will appear in the menu bar (see section 7.6 "System messages").

Most system messages are reset automatically once the fault has been resolved.

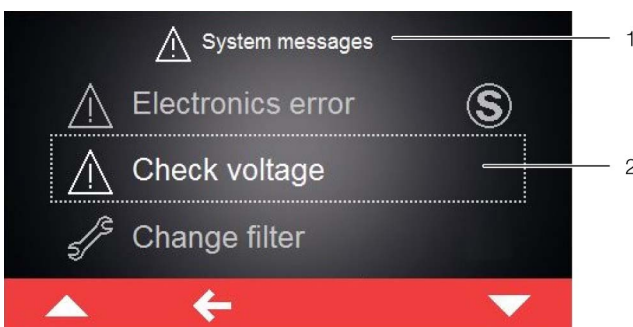

Fig. 27: Screen showing error messages

Key

- 1 "Errors" menu
- 2 Error message

If an error message applies that cannot be resolved by the operator himself and which is not reset automatically, the "Service" symbol will appear after the error mes-

sage and in the control bar next to the symbol for system messages (fig. 28, item 2).

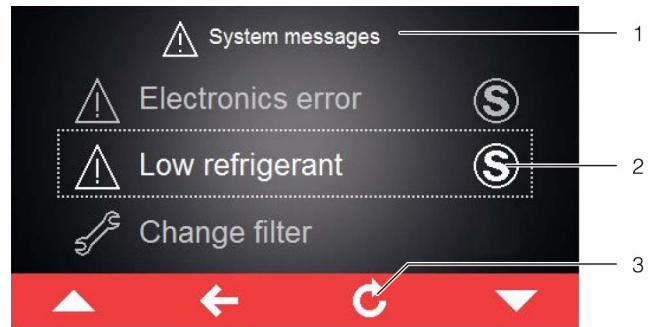

Fig. 28: Screen showing error messages

Key

- 1 "Errors" menu
- 2 Error message
- 3 "Return" button

- Contact Rittal Service (see section 14 "Customer service addresses").
- Acknowledge the error message by pressing the "Return" button.











7 Operation

EN

















7.7 List of system messages

The applicable error messages are displayed with the corresponding symbol in the Errors list (see section 7.6 "System messages"). Extended information for resolving individual faults may be found in this section.

Contact details for the Rittal Service team can be found in section 14 "Customer service addresses".

System message	Alarm relay output (factory setting)	Troubleshooting measures/solutions
Door open 	–	Please close the enclosure door and check the door contact switch. The error message will terminate automatically approximately 30 seconds after it has been resolved.
Int.temp too high 	–	The measured interior temperature exceeds the set alarm limit for your cooling unit. Please check any maintenance and error messages, and check the rating of your cooling unit. For any further questions, please contact Rittal Service directly.
Change filter 	–	The filter mat in your cooling unit is dirty. Please replace or clean the filter mat and confirm this by pressing reset in the list of system messages on the cooling unit display.
Clean condenser 	–	The condenser in your cooling unit is dirty. Please remove the top louvred grille and clean the heat exchanger, e.g. using compressed air. The error message will terminate automatically approximately 30 seconds after it has been resolved.
Ext. air circuit 	1	The air inlet or outlet in the external circuit is blocked. Please remove the blockage and ensure that minimum distances from the air inlet or outlet are observed.
Int. air circuit 	–	The air inlet or outlet in the internal circuit is blocked. Please remove the blockage and ensure that minimum distances from the air inlet or outlet to components inside the enclosure are observed.
Exp. valve defect 	–	A malfunction has been detected in the electronic expansion valve. Please contact your Rittal Service.
Ext.temp too high 	–	Your cooling unit is being operated outside of the admissible ambient temperature. Please ensure that the ambient temperature does not exceed the admissible range (-20 °C...+60 °C/-4 °F...+140 °F).
Low refrigerant 	2	Your cooling unit is reporting a lack of cooling in the active refrigerant cycle. Please contact the Rittal Service team immediately. The system message will need to be acknowledged manually once the cause has been rectified.
Condensate alert 	1	Please check whether the condensate water drain of your cooling unit is blocked, and remove the blockage. If you are unable to resolve the fault, please contact your Rittal Service team.
Int. fan alarm 1 	1	The fan in the internal circuit of your cooling unit is blocked. Please check if you can see a blockage and remove it. If no blockage is visible, please replace the fan in the internal circuit. The required spare part may be ordered directly from Rittal using the Blue e+ app. Please use the contact form "Generate service order".



Tab. 24: Error messages

System message	Alarm relay output (factory setting)	Troubleshooting measures/solutions
Int. fan alarm 2 	1	The fan in the internal circuit of your cooling unit is defective. Please replace the fan in the internal circuit. The required spare part may be ordered directly from Rittal using the Blue e+ app. Please use the contact form "Generate malfunction report".
Ext. fan alarm 1 	1	The fan in the external circuit of your cooling unit is blocked. Please check if you can see a blockage and remove it. If no blockage is visible, please replace the fan in the external circuit. The required spare part may be ordered directly from Rittal using the Blue e+ app. Please use the contact form "Generate service order".
Ext. fan alarm 2 	1	The fan in the external circuit of your cooling unit is defective. Please replace the fan in the external circuit. The required spare part may be ordered directly from Rittal using the Blue e+ app. Please use the contact form "Prepare malfunction report".
Inverter cooler 	–	The cooling body of the inverter in your cooling unit is dirty. Please remove the filter grille and the cover at the front and clean the cooling body, e.g. using compressed air. The error message will terminate automatically approximately 30 seconds after it has been resolved.
Compressor defect  	2	The compressor in your cooling unit is reporting a malfunction. Please contact the Rittal Service team immediately.
Sensor xx defect  	1	Sensor xx in your cooling unit is reporting a sensor failure. Please contact the Rittal Service team.
Ext.sens. missing 	1	The external sensor is not connected or has a malfunction. Please check the connection or select another control mode.
Check voltage 	1	You are operating your cooling unit outside of the admissible voltage ranges. Please check the power supply to the cooling unit and observe the specifications on the rating plate. With a three-phase infeed, please also check that all three phases are correctly connected.
Electronics error  	2	The electronics in your cooling unit are reporting an electronic fault. Please contact the Rittal Service team.
Check parameters 	–	Due to an error, the cooling unit has been reset to the factory defaults. Please check the current messages or contact your Rittal Service team.
Inverter fault  	2	The inverter in your cooling unit is reporting a malfunction. Please contact the Rittal Service team.
Alarm mode active 	–	Due to a previous error your cooling unit is only operating with a performance of 50%. Please remedy this error and/or contact your Rittal Service team.

Tab. 24: Error messages

7 Operation

EN

System message	Alarm relay output (factory setting)	Troubleshooting measures/solutions
Compressor phase 	2	The compressor in your cooling unit is reporting a malfunction. Please contact your Rittal Service team.
Overload 	1	Please check the rating of your cooling unit. For any further questions, please contact your Rittal Service team directly.
Alarm act.cooling 	–	The active cooling function of your unit is defective. Please contact the Rittal Service team immediately, and/or check the rating of your cooling unit.

Tab. 24: Error messages

8 Inspection and maintenance

8.1 Safety instructions for maintenance work

The unit must be opened in order to carry out maintenance work. There is a risk of injury from electric shock.

- Switch off the power supply before carrying out maintenance work.
- Secure the power supply to prevent it being switched back on accidentally.
- Disconnect the electrical connection cable of the cooling unit from the power supply at the connection box.
- Wait at least five minutes before handling the unit. Only then will the capacitors built into the unit have discharged themselves.
- When handling the enclosure, be aware of any exposed power sources, where applicable.
- If possible, disconnect the entire enclosure from the power.

There is also a risk of injury from sharp edges, such as the louvres of the heat exchanger.

- Wear cut-resistant gloves for all maintenance work. After removing the cover, there is a risk of burn injuries from hot surfaces on the components inside the unit.
- Before carrying out any work on the interior of the unit, allow it to cool down for at least ten minutes.

8.2 Notes on the refrigerant circuit

The cooling unit is filled with the amount of refrigerant required at the factory, checked for leaks, and subjected to a functional test run. The refrigerant circuit is designed in the form of a maintenance-free, hermetically sealed system. For this reason, the operator should not carry out any maintenance work on the refrigerant circuit.



Caution!
Maintenance tasks on the refrigerant circuit must only be undertaken by a qualified refrigeration specialist.

8.3 Maintenance work on the cooling unit

If there is visible dirt present, the components in the outer air circuit should be cleaned using a vacuum cleaner or compressed air.



Note:
The maintenance intervals given below depend to a large extent on the level of contamination in the ambient air. For heavily contaminated air, the maintenance intervals will be reduced accordingly.

- Clean the cooling unit inside and out at least every 5,000-8,000 operating hours as described in section 8.4 "Compressed air cleaning".

- Any stubborn, oily stains may additionally be removed using a non-flammable detergent, such as degreaser.



Caution!
Never use flammable liquids for cleaning the unit.

The installed maintenance-free fans are mounted on ball bearings, protected against moisture and dust, and fitted with a temperature monitor.

- Rittal recommends that the cooling unit fans should be checked e.g. for unusual running noises after around 40,000 operating hours.

8.4 Compressed air cleaning

8.4.1 Dismantling a unit with full internal mounting

Cooling units with full internal mounting in the enclosure must first be completely removed from the mounting cut-out before cleaning with compressed air.

- Remove the cooling unit from the rack mount in the reverse order as for installation (see section 5.3.7 "Full internal mounting of the cooling unit")
- Hold the threaded bolts in place with a screwdriver in order to loosen the nuts.
- Then dismantle the unit as described in section 8.4.2 "Dismantling the unit".

8.4.2 Dismantling the unit



Note:
In principle, the unit is dismantled in the reverse order from assembly.

- At the front of the cooling unit, pull the top louvred grille away from the mounting clips on the cover, and place or lay it down somewhere safe.

8 Inspection and maintenance

EN

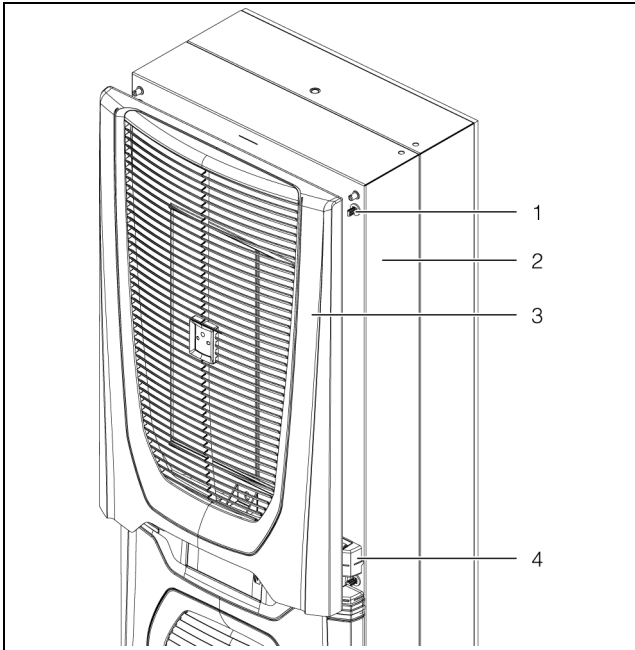

Fig. 29: Remove the top louvred grille (example illustration)

Key

- 1 Mounting clip
- 2 Cover
- 3 Top louvred grille
- 4 Infill panel on cooling unit

- Flip open the bottom louvred grille below the infill panel.
- Release the two stays in the top hinge mechanism from the brackets attached to the cover of the cooling unit.

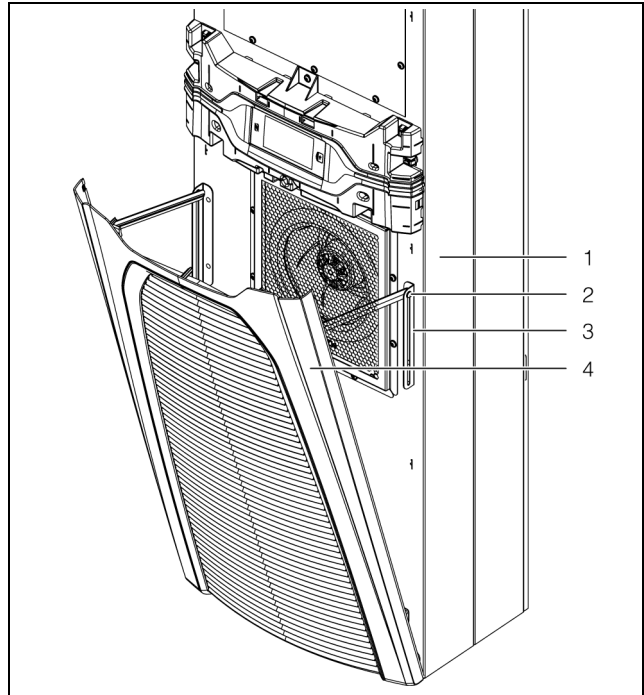

Fig. 30: Attachments on hinge mechanism (example illustration)

Key

- 1 Cover
- 2 Stays in hinge mechanism
- 3 Bracket
- 4 Bottom louvred grille

- Pull the bottom louvred grille forwards out of its holders, and place or lay it down somewhere safe.

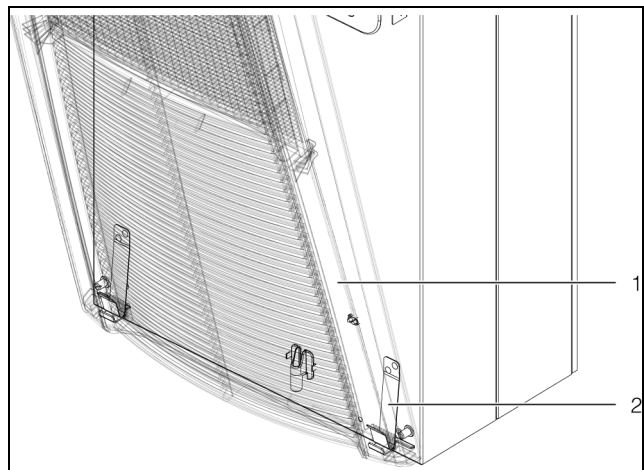

Fig. 31: Bottom holders of louvred grille (example illustration)

Key

- 1 Bottom louvred grille
- 2 Holders

- Gently pull the infill panel, including display, forwards to release it from the mounting clips on the cover.

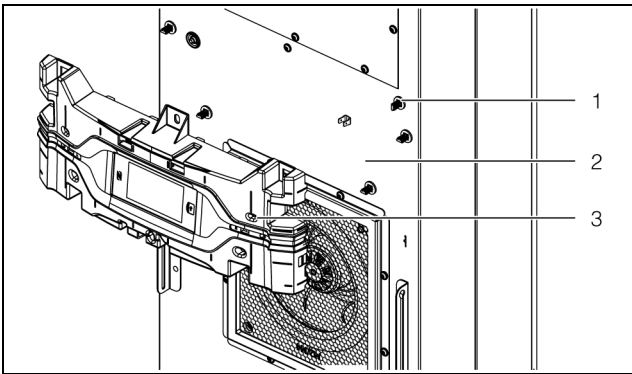

Fig. 32: Remove the infill panel (example illustration)

Key

- 1 Mounting clips
- 2 Cover
- 3 Infill panel

- On the rear of the display, disconnect both of the connectors (PE conductor and connection) and remove the infill panel completely from the cooling unit.

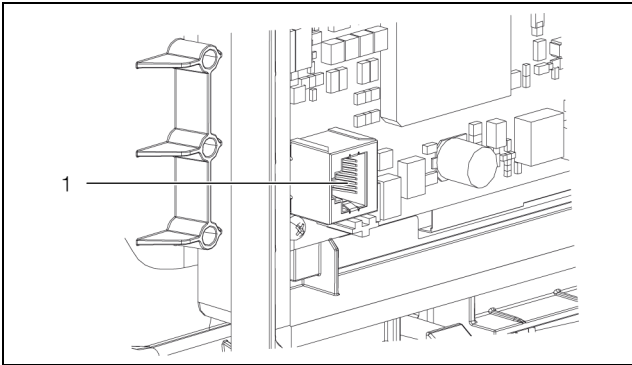

Fig. 33: Connection point on rear of cooling unit

Key

- 1 Connection point

- Place the infill panel somewhere safe.
- Carefully push the connector including connection cable inwards through the cable gland in the cover.

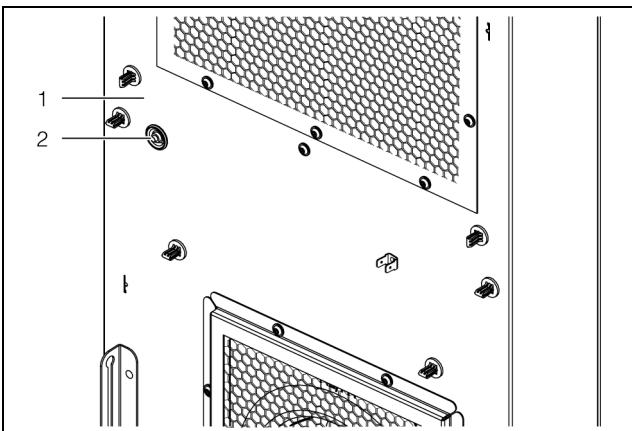

Fig. 34: Cable gland in cover (example illustration)

Key

- 1 Cover
- 2 Cable gland



Caution!

The cooling unit will only be stable as long as the cover and chassis are connected. For this reason, be sure to brace the chassis, in particular, to stop it falling over before removing the cover.

- Loosen the six spring terminals used to connect the cooling unit and enclosure door or side panel. You may wish to use a screwdriver to press the stays back in order to remove the spring terminals.

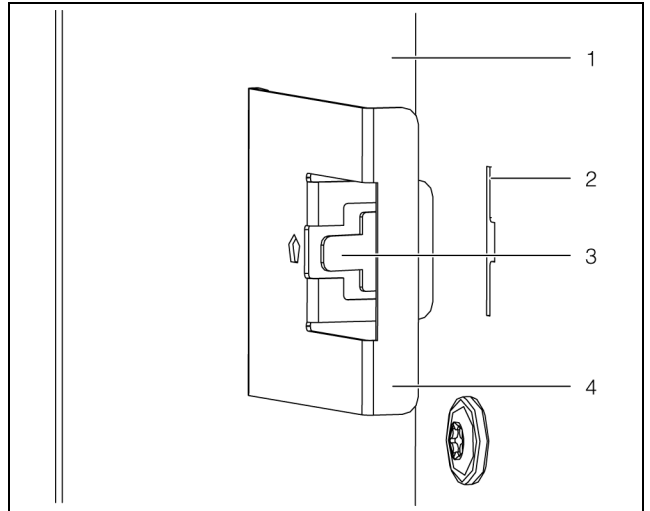

Fig. 35: Loosen the spring terminals

Key

- 1 Enclosure door or side panel
- 2 Opening for screwdriver in cooling unit
- 3 Stays
- 4 Spring terminal



Caution!

After removing the cover, there is a risk of burn injuries from hot component surfaces inside the unit.

- Allow the unit to cool down for at least ten minutes before removing the cover. This should allow hot surfaces inside the unit to cool down sufficiently.
- Loosen the four threaded bolts in the corners of the cover which connect the cover to the chassis.
- Carefully pull the cover forwards (approx. 5 cm) from the chassis. The PE conductor connection between the cover and the chassis is located on the left-hand side, around half-way up.

8 Inspection and maintenance

EN

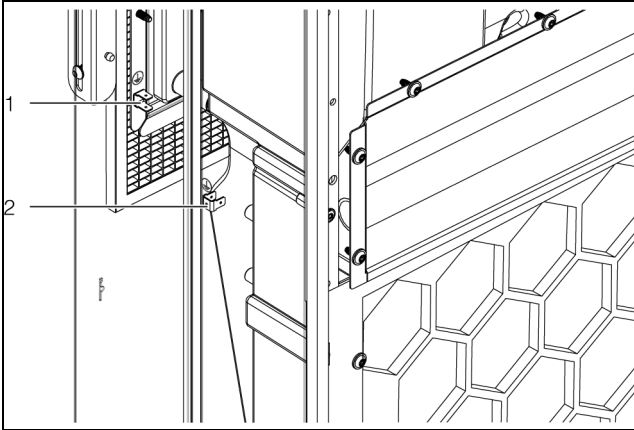

Fig. 36: PE conductor connection viewed from behind (example illustration)

Key

- 1 PE conductor connection, cover
- 2 PE conductor connection, chassis

- Disconnect the PE conductor's flat-pin connector from the inside, preferably on the chassis.
 - Remove the cover completely from the chassis, and place or lay it down somewhere safe.
- Dismantling of the unit is now complete.

8.4.3 Cleaning the components with compressed air

After removing the cover from the unit, you will be able to access the components in the outer circuit, particularly the condenser, the condenser fan and the compressor chamber.

- Wear cut-resistant gloves when cleaning with compressed air, so as to avoid injuries caused by sharp edges inside the unit.
- When cleaning the components with compressed air, blow dirt sideways out of the cooling unit.
- Alternatively, use a suitable vacuum cleaner to clean all components.

8.4.4 Re-assembling the cooling unit

Once the cleaning work is complete, the cooling unit must be sealed and, in the case of full internal mounting, fitted back into the mounting cut-out.

- First, completely re-assemble the cooling unit.
It is assembled in the reverse order from dismantling (see section 8.4.2 "Dismantling the unit"), in the same way as for the initial assembly (see section 5.3 "Assembly procedure").
- For full internal mounting of the cooling unit, re-insert it into the mounting cut-out.
- Make the electrical connection for the cooling unit.

9 Storage and disposal



Note:

When storing the cooling unit, please observe the temperature range given in the technical specifications.

- Store the cooling unit in the appropriate position for transport.

The closed refrigerant circuit contains refrigerant and oil which must be properly disposed of for the sake of the environment. Facilities for disposal are available at the Rittal plant or a specialist company. Give us a call (see section 14 "Customer service addresses").

10 Technical specifications

EN

10 Technical specifications

Pos.	Technical specifications		SK 3185830 SK 3185835 SK 3185530	SK 3186930 SK 3186935 SK 3186630	SK 3187930 SK 3187935 SK 3187630	SK 3188940 SK 3188945 SK 3188640	SK 3189940 SK 3189945 SK 3189640
General specifications							
	Model No. sheet steel version		SK 3185830	SK 3186930	SK 3187930	SK 3188940	SK 3189940
	Model No. chemical version		SK 3185835	SK 3186935	SK 3187935	SK 3188945	SK 3189945
	Model No. V2A 1,4301		SK 3185530	SK 3186630	SK 3187630	SK 3188640	SK 3189640
	Dimensions (width x height x depth) [mm]		400 x 950 x 310	450 x 1600 x 294		450 x 1600 x 393	
Cooling output and efficiency ratings							
7	Total cooling output Pc to EN 14511 [kW]	L35 L35	1.60	2.00	2.60	4.00	5.50
		L35 L50	1.20	1.29	1.70	3.02	3.95
	Sensible cooling capacity Pc to EN 14511 [kW]	L35 L35	1.60	2.00	2.60	4.00	5.03
		Power consumption Pel to EN 14511 [kW]	L35 L35	0.54	0.62	0.99	1.30
		L35 L50	0.61	0.60	0.94	1.28	2.20
9	Energy efficiency ratio (EER)	L35 L35	2.96	3.23	2.63	3.08	2.5
Electrical specifications							
1	Rated voltage [V, ~], tolerance	+10%/-10%	110...240, 1			-	
		+5%/-15%	380...480, 3				
2	Rated frequency [Hz]		50/60				
	Rated insulation voltage Ui [V]		500				
	Rated impulse withstand voltage Uimp [V]		4000				
3	Rated output [kW]		0.70	0.73	1.05	1.45	2.35
4	Rating of over current protective device [A]		15				
5	Minimum circuit ampacity [A]		15				
6	Input ampere range [A]		6.9@110 V – 1.2@380 V	7.3@110 V – 1.3@380 V	11@110 V – 1.8@380 V	2.5@380 V – 1.9@480 V	3.9@380 V – 3.1@480 V
	Pre-fuse T [A] (Time delay fuse type CCMR)	EN 61439	16				
		UL 508A	15				
	Cable cross-section [mm ²]	EN 61439	1.5				
		UL 508A	2.1				
	Overvoltage category		III				
	Level of contamination		III				
Protection category							
18	IP protection category		24				

Tab. 25: Technical specifications Blue e+

10 Technical specifications

EN

Pos.	Technical specifications		SK 3185830 SK 3185835 SK 3185530	SK 3186930 SK 3186935 SK 3186630	SK 3187930 SK 3187935 SK 3187630	SK 3188940 SK 3188945 SK 3188640	SK 3189940 SK 3189945 SK 3189640
Protection category with the unit externally mounted							
19	IP protection category						55
20	UL type rating						12
Electromagnetic compatibility							
	Immunity to interference						For industrial areas to EN 61000-6-2
	Emitted interference						For residential, business and commercial areas and small companies to EN 61000-6-3
Technical specifications for a suitable overvoltage protection module							
	Terminal voltage U_c [V, Hz]						350...400, 50/60
	Maximum current I_{max} [kA]						40
	Rated current I_n [kA]						20
	Breakdown voltage U_p [kV]						1.75
Refrigerant circuit							
17	Admissible pressure (PS) HD/ND [MPa]						2.4
11	Operating temperature range [°C/°F]						-20...+60/-4...+140
	Heat pipe active mode [°C/°F]						0...+60/+32...+140
	Refrigerant cycle active mode [°C/°F]						+10...+60/+50...+140
	Setting range set value [°C/°F]	Internal temperature					+20...+50/+68...+122
		External sensor					+20...+50/+68...+122
		Outlet temperature					+18...+28/+64.4...+82.4
14	Refrigerant identification						R-513A (44% R134a Tetrafluorethane (CH ₂ FCF ₃), 56% R1234yf Tetrafluorpropene (C ₃ H ₂ F ₄))
12	Refrigerant filling mass compression system [g]		450		650		1100
13	Refrigerant filling mass heat pipe system [g]		310		420		700
15	GWP						631
16	CO ₂ e [t]		0.48		0.68		1.14
Other							
	Weight [kg]		30.5		55.2		72.4
	Storage temperature range [°C/°F]						-40...+70/-40...+158
	Noise pressure level L_p [dB(A)]				<67	<70	<71
	Humidity [%]						5...95, non-condensing



Tab. 25: Technical specifications Blue e+

10 Technical specifications

EN

Pos.	Technical specifications	SK 3185830 SK 3185835 SK 3185530	SK 3186930 SK 3186935 SK 3186630	SK 3187930 SK 3187935 SK 3187630	SK 3188940 SK 3188945 SK 3188640	SK 3189940 SK 3189945 SK 3189640
35	Manufacture date	DD.MM.YY				
21	Assembly and operating instructions symbols					
	Approvals	See product page on the Rittal website				

Tab. 25: Technical specifications Blue e+

SK <input type="text"/>		KID No.: <input type="text"/>	
S/N: <input type="text"/>		Rev. <input type="text"/>	
		Client spec.: <input type="text"/>	
Enclosure Cooling Unit Blue e+		机柜冷却装置 Blue e+	
		<input type="text" value="32"/>	
Rated voltage/ 额定电压	<input type="text" value="1"/>	Refrigerant charge compression system/ 压缩机系统制冷剂冲注量	<input type="text" value="12"/>
Rated frequency/ 额定频率	<input type="text" value="2"/>	Refrigerant charge heat pipe system/ 热管系统制冷剂冲注量	<input type="text" value="13"/>
Rated power input/ 额定功耗	<input type="text" value="3"/>	Refrigerant ID/ 制冷剂型号	<input type="text" value="14"/>
Rating of over current protective device (fuse or circuit breaker as defined in manual)/ 额定过载电流保护装置 (说明书定义熔断保险丝)	<input type="text" value="4"/>	GWP	<input type="text" value="15"/>
Minimum circuit ampacity/ 最小的电路载流量	<input type="text" value="5"/>	CO2e	<input type="text" value="16"/>
Input ampere range/ 输入电流范围	<input type="text" value="6"/>	Allowable pressure (PS)/ 允许压力	<input type="text" value="17"/>
Total cooling capacity DIN EN 14511/ 符合 DIN EN 14511 的总制冷量	<input type="text" value="7"/>	IP-Code/ IP 防护等级	<input type="text" value="18"/>
SCCR/ 短路电流额定值	<input type="text" value="8"/>	Environmental IP Rating/ 环境侧 IP 防护等级	<input type="text" value="19"/>
EER A35 A35/ 能效比 A35 A35	<input type="text" value="9"/>	Environmental Type Rating/ 环境侧防护等级	<input type="text" value="20"/>
EER A35 A20/ 能效比 A35 A20	<input type="text" value="10"/>	Manufacturing date/ 生产日期	<input type="text" value="35"/>
Temperature range/ 温度范围	<input type="text" value="11"/>	Hermetical sealed	<input type="text" value="21"/>
		Leakage tested EN-378-2	<input type="text" value="22"/>
<input type="text" value="23"/>	<input type="text" value="25"/>	<input type="text" value="29"/>	<input type="text" value="33"/>
<input type="text" value="26"/>	<input type="text" value="27"/>	<input type="text" value="30"/>	<input type="text" value="31"/>
Appliance should not be accessible to the general public.			
For Product and Service information use the QR-Code or visit www.rittal.com		<input type="text" value="21"/>	QR-Code
RITTAL GmbH & Co. KG, Auf dem Stuetzelberg, 35745 Herborn		<input type="text" value="34"/>	
RITTAL Limited, Braithwell Way, Helliaby Rotherham, S66 8QY, UK		<input type="text" value="34"/>	
FRIEDHELM LOH GROUP			

11 List of spare parts

Spare parts may be ordered directly from the Rittal website.



Note:

The components used are Rittal-specific components. We recommend using only original Rittal spare parts to ensure the guaranteed unit properties (output).

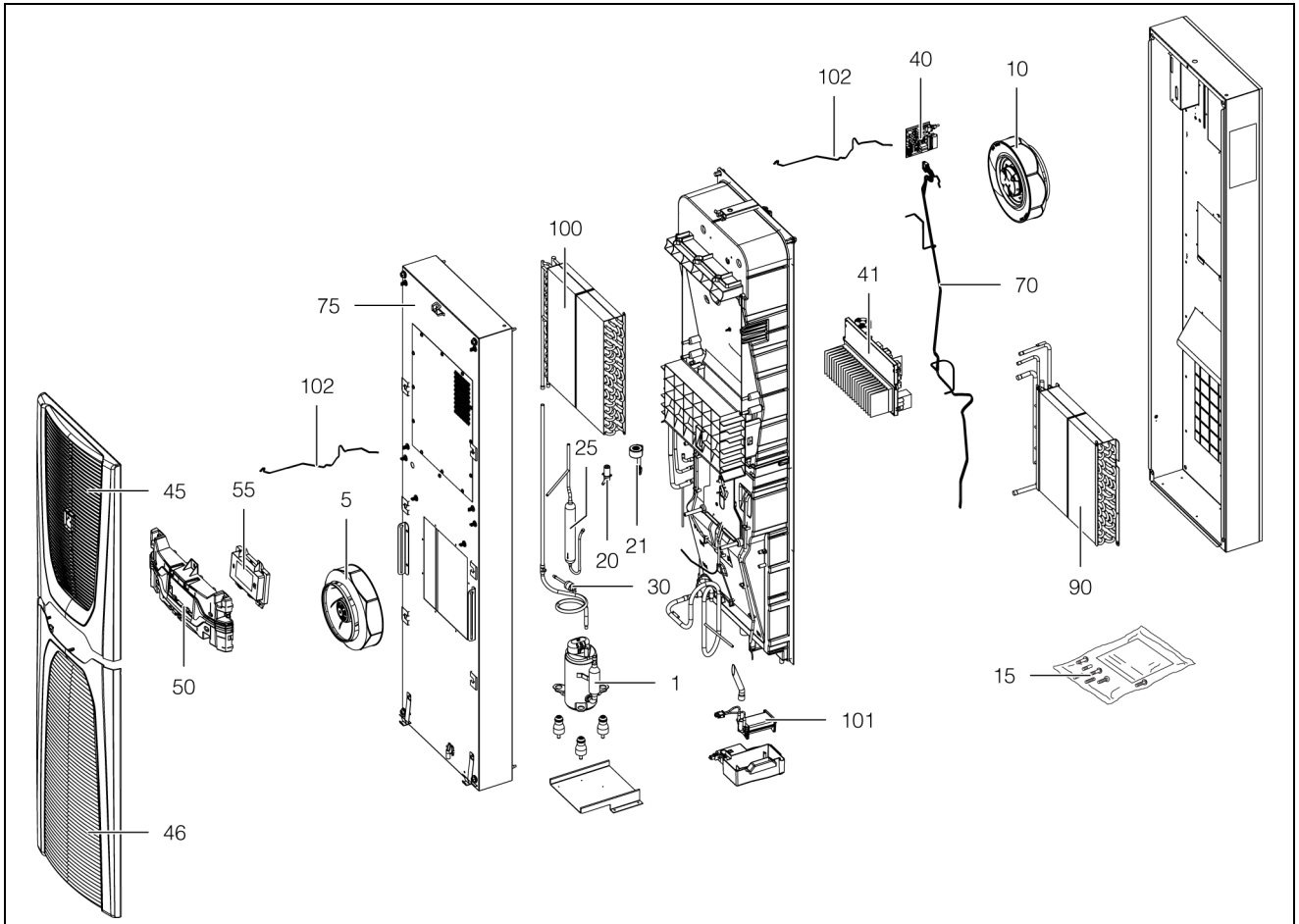

Fig. 37: Spare parts (example illustration)

Key

- 1 Compressor
- 5 Condenser fan
- 10 Evaporator coil fan
- 15 Dispatch bag as accessories bag
- 20 Expansion valve
- 21 Coil for expansion valve
- 25 Filter dryer
- 30 PSA^H pressure-operated switch as pressostat
- 40 I/O-board
- 41 Inverter
- 45 Louvred grille, top
- 46 Louvred grille, bottom
- 50 Infill panel
- 55 Display/controller
- 70 Temperature sensor kit
- 75 Cover
- 90 Evaporator coil
- 100 Condenser
- 101 Condensate water evaporator
- 102 Display cable

12 Drawings

12.1 Representation of mounting cut-outs SK 3185x3x

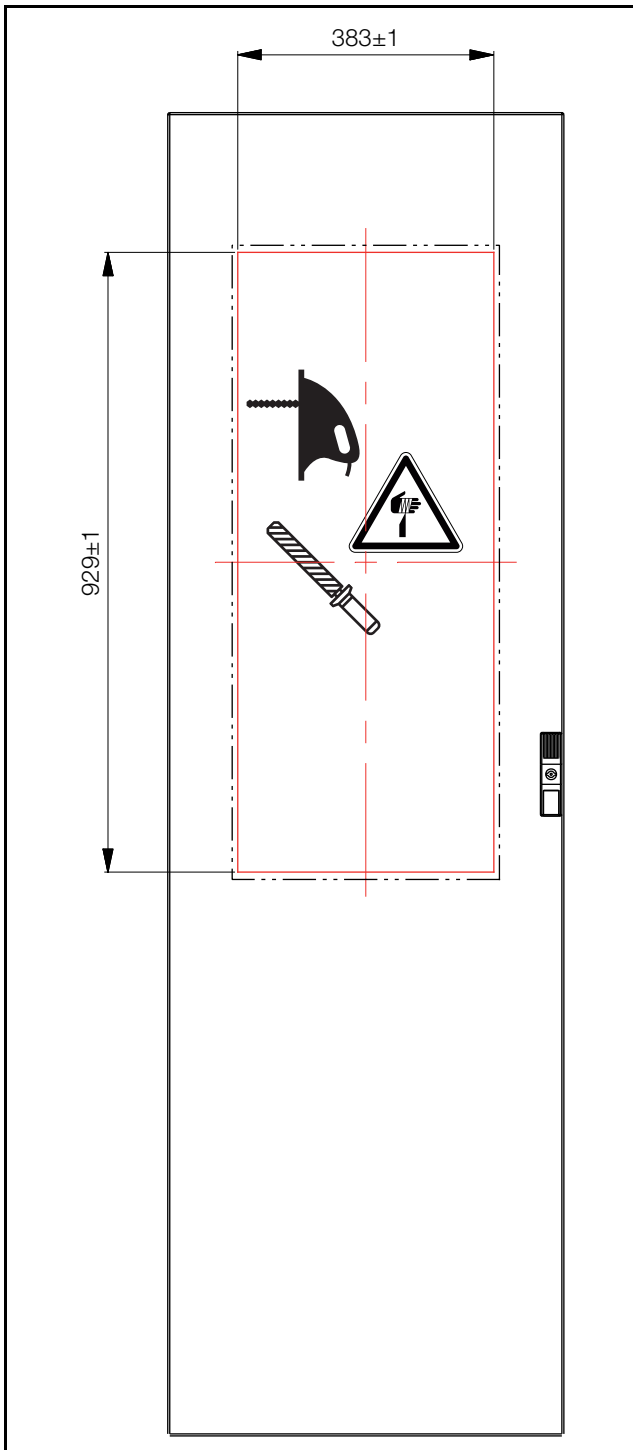

Fig. 38: Mounting cut-out

SK 3186x3x/SK 3187x3x/SK 3188x4x/SK 3189x4x

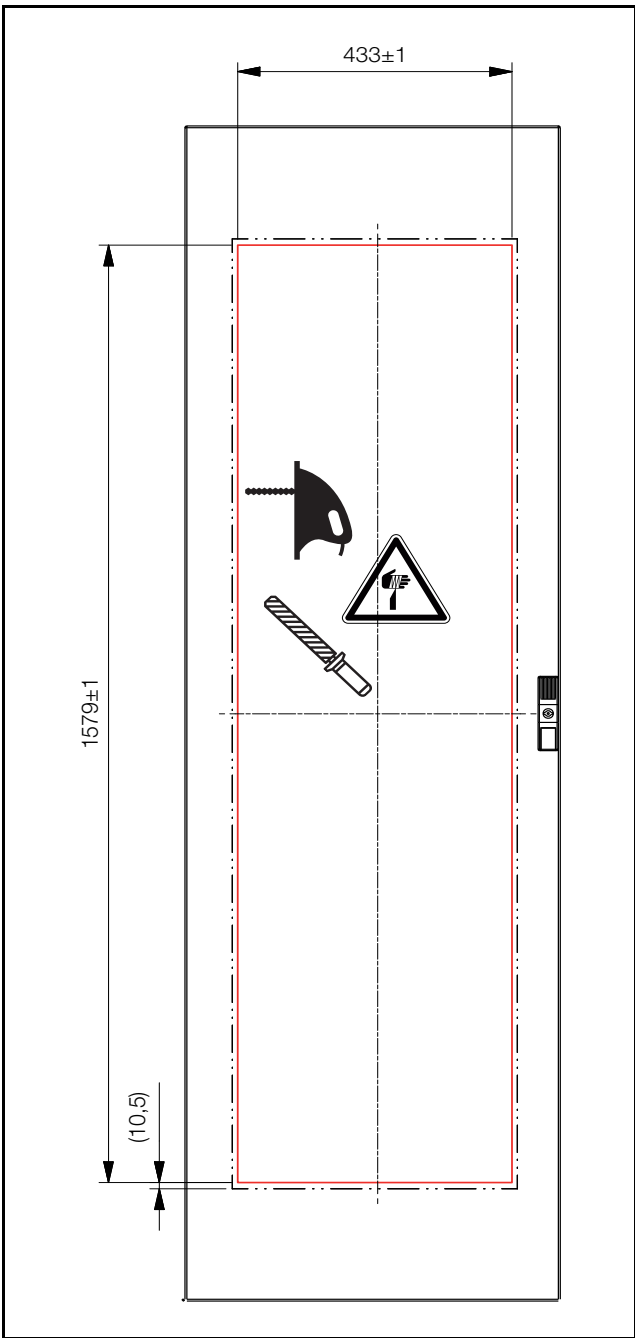

Fig. 39: Mounting cut-out

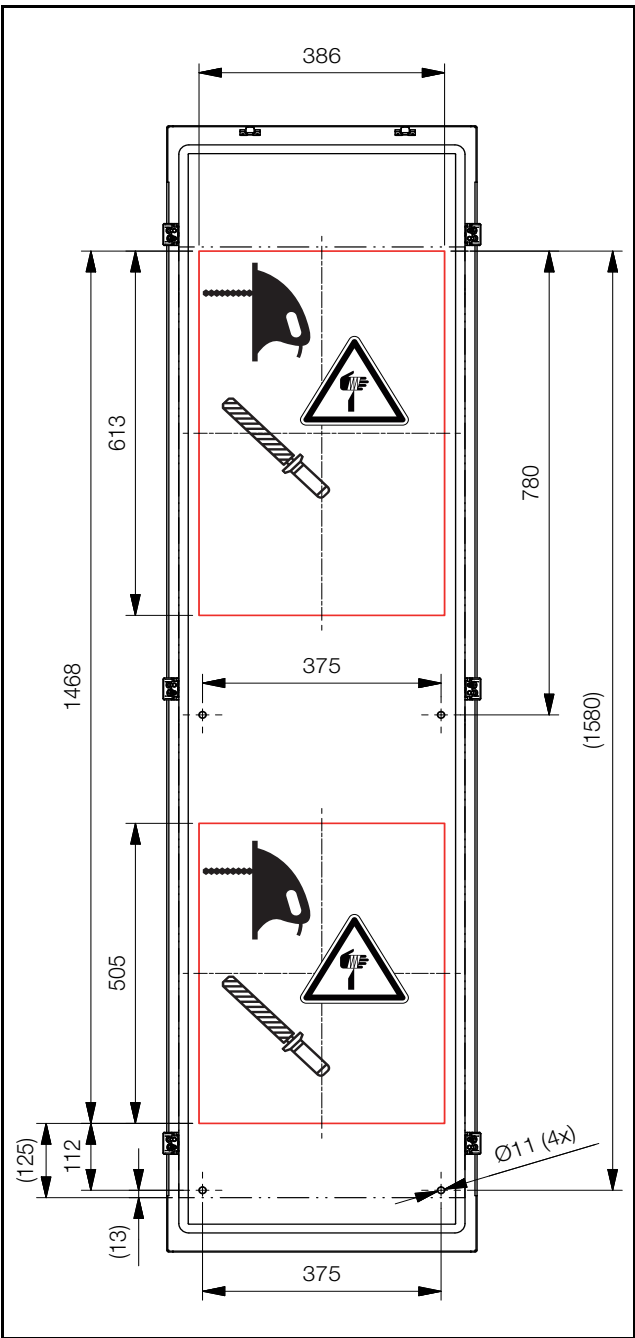

Fig. 40: Mounting cut-out for 500 mm deep enclosure

12 Drawings

EN

12.2 Dimensions and installation depths SK 3185x3x

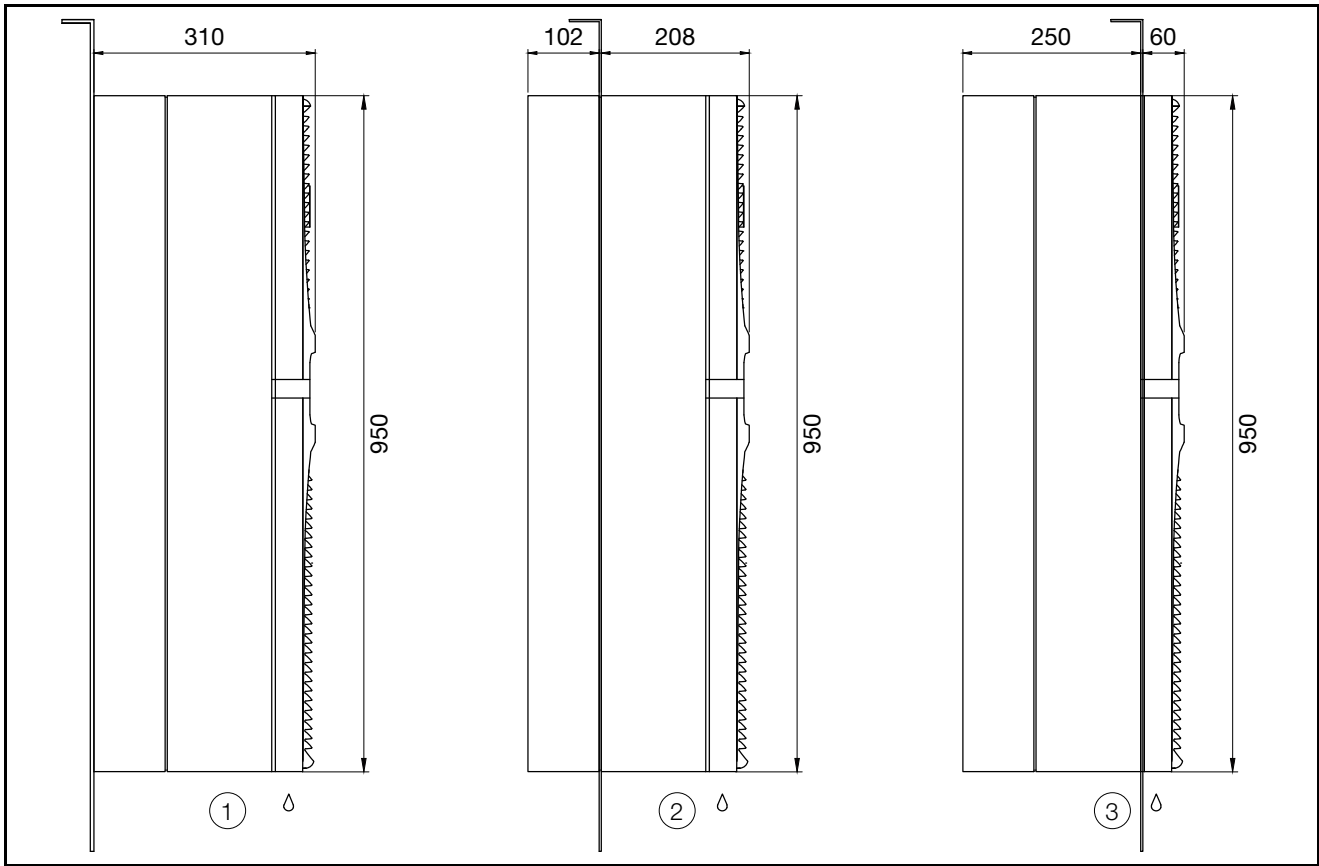

Fig. 41: Dimensions SK 3185x3x

Key

- 1 External mounting
- 2 Partial internal mounting
- 3 Full internal mounting

SK 3186x3x & SK 3187x3x

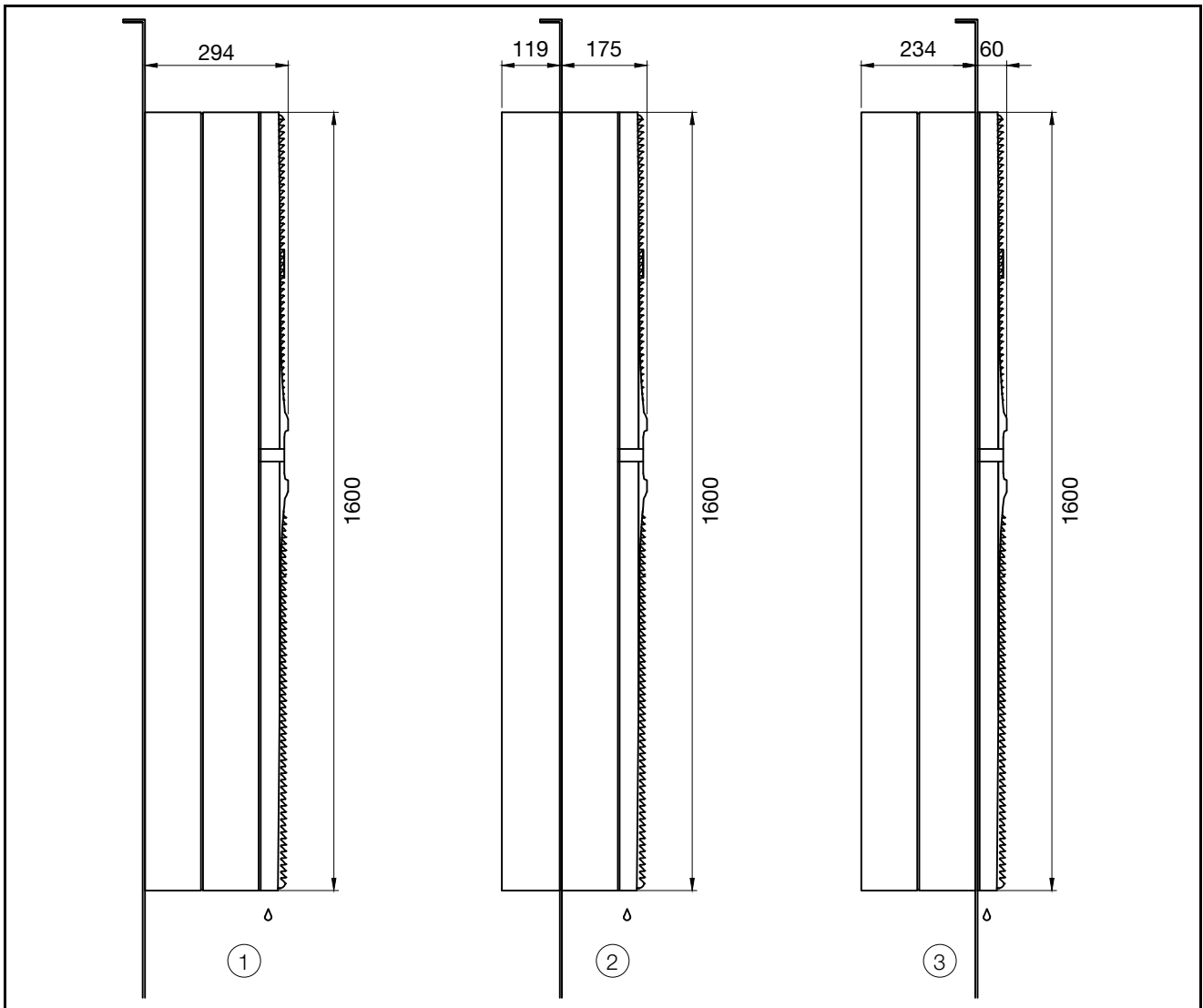

Fig. 42: Dimensions SK 3186x3x and SK 3187x3

Key

- 1 External mounting
- 2 Partial internal mounting
- 3 Full internal mounting

SK 3188x4x & SK 3189x4x

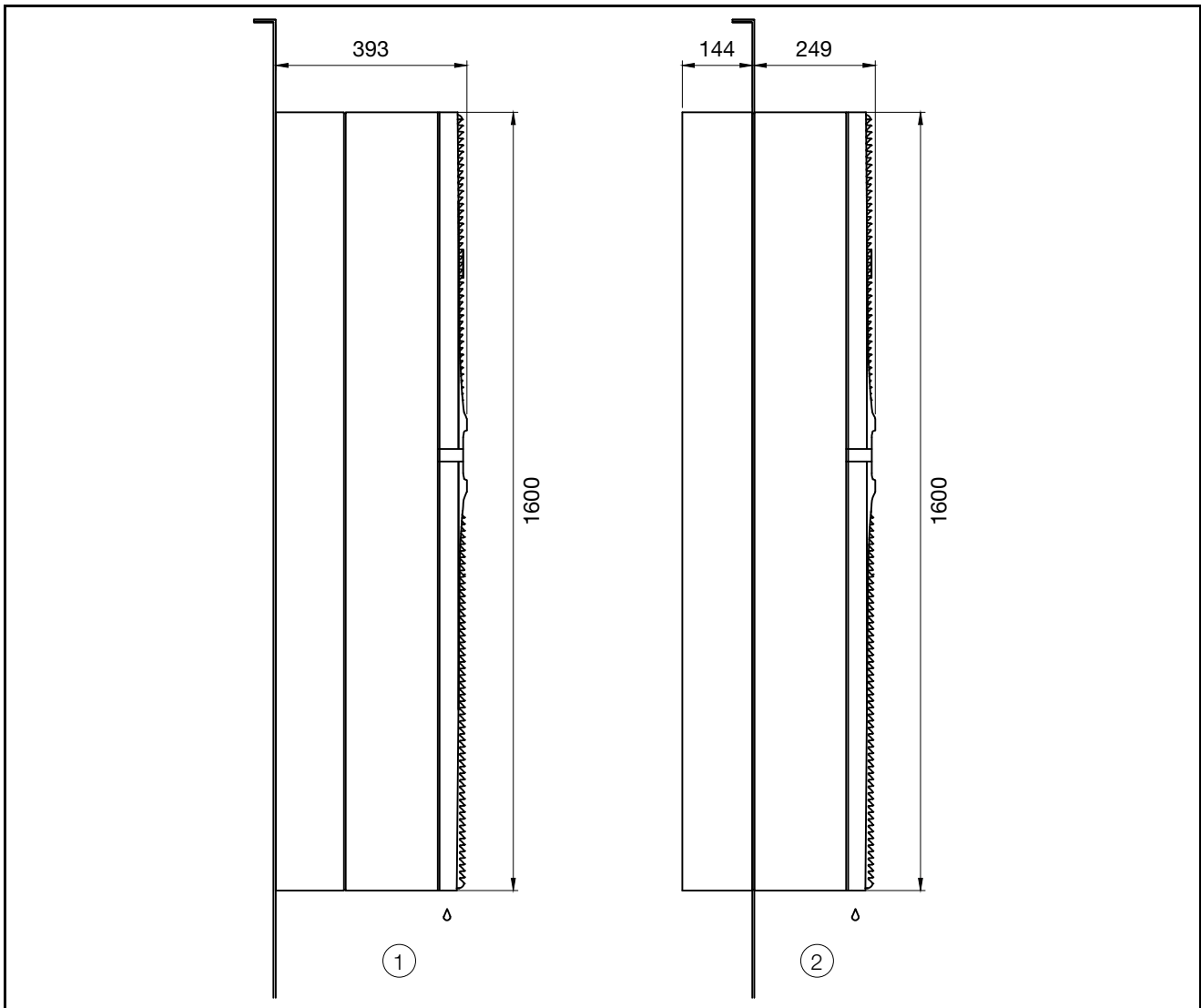





Fig. 43: Dimensions SK 3188x4x and SK 3189x4x

Key

- 1 External mounting
- 2 Partial internal mounting

13 Accessories

As well as the accessories listed below, details of our full range of accessories can be found on the Rittal website.

Item	SK 3185x3x	SK 3186x3x SK 3187x3x	SK 3188x4x SK 3189x4x
External temperature sensor	SK 3124400		
Filter mats	SK 3285800	SK 3285900	
Condensate water hose	SK 3301612		
Door limit switch	SZ 4127010		
IoT Interface	SK 3124300		
Cover for connection box	SK 3355200	SK 3355210	
M12 eyebolt	SZ 4568000		
Pre-fuse	SK 3235600		–
	SK 3235610		
	SK 3235620		
"Rittal Scan & Service" app	  <div style="display: flex; justify-content: space-around; align-items: center;"> <div style="text-align: center;">  </div> <div style="text-align: center;">  </div> </div>		

14 Customer service addresses

EN

14 Customer service addresses

Contact details can be found on the Rittal website at:

– <https://www.rittal.com/rittal-locations>

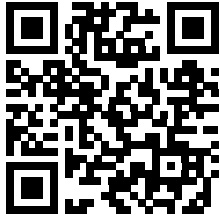

15 Compact service information

Step	See	OK/comment
Assembly and connection		
– Installation site requirements taken into account	Section 5.2	
Assembly instructions		
– Observe the relevant assembly instructions	Section 5.3.1	
– Condensate water discharge connected	Section 5.3.8	
– Electrical installation (overvoltage protection, door limit switch)	Section 5.4	
Commissioning		
Check the assembly – All attachments checked, filter mat fitted		
Commissioning – At least 30 minutes after assembly	Section 6	
– Download the Blue e+ app to support commissioning and subsequent operation		
– Commissioning check carried out via Blue e+ app		
Operation		
– Check the device status during operation using the Blue e+ app		
– Read maintenance instructions and warnings or fault messages using the Blue e+ app		

Tab. 26: Quick installation check

For all other service enquiries:

Original spare parts	Maintenance, warranty extensions (up to 5 years), service contracts
<ul style="list-style-type: none"> – Enquire directly via Blue e+ app – http://www.rittal.com 	<ul style="list-style-type: none"> – Enquire directly via Blue e+ app – http://www.rittal.com – Enquire at the relevant national company – http://www.rittal.com/de_de/service_contact/index.asp
Other service contacts worldwide: Rittal International Service HUBs (see section 14 "Customer service addresses")	

Tab. 27: Service contacts worldwide

Rittal – The System.

Faster – better – everywhere.

- Enclosures
- Power Distribution
- Climate Control
- IT Infrastructure
- Software & Services

You can find the contact details of all Rittal companies throughout the world here.



www.rittal.com/contact

RITTAL GmbH & Co. KG
Auf dem Stuetzelberg · 35745 Herborn · Germany
Phone +49 2772 505-0
E-mail: info@rittal.de · www.rittal.com

08.2024 / D-0000-00001273-02-EN

ENCLOSURES

POWER DISTRIBUTION

CLIMATE CONTROL

IT INFRASTRUCTURE

SOFTWARE & SERVICES

FRIEDHELM LOH GROUP

