

Rittal – The System.

Faster – better – everywhere.

AX. KX. Stainless steel

Compact and small enclosures.



ENCLOSURES

POWER DISTRIBUTION

CLIMATE CONTROL

IT INFRASTRUCTURE

SOFTWARE & SERVICES



FRIEDHELM LOH GROUP

Rittal's flexible, robust solutions are designed to protect your systems

Rittal's AX and KX stainless steel enclosures are your dependable allies for optimum system protection. The AX series offers versatile protection from various external influences such as dust and humidity, and its flexible design means it adapts readily to a range of applications. For example, the wider door space with perforated door strips creates additional storage space while also boosting efficiency.

The KX terminal box series and KX E-Box series offer additional options to accommodate various applications. The KX terminal box series is a closed empty housing with cover and quick-release fasteners, while the KX E-Box series provides a closed variant with door and hinges. The KX bus enclosure series is an alternative option.

These enclosures are ideal for protecting and organising your valuable components in challenging environments, be it industrial installations, control units or other applications where reliable storage is paramount.



Contents

The Rittal value chain

Joining forces to add value	Page 4
RIPanel	Page 6
Rittal ePOCKET	Page 7

Compact enclosures AX

Top customer benefits.....	Page 8
Basic enclosure AX, stainless steel	Page 11

Small enclosures KX

Top customer benefits.....	Page 16
Terminal boxes KX, stainless steel	Page 19
E-Box KX, stainless steel	Page 21
Bus enclosures KX, stainless steel.....	Page 23

System accessories AX, KX

System accessories AX, KX	From page 24
---------------------------------	--------------

Technical information

Technical information	Page 50
-----------------------------	---------

Joining forces to add value

Powerful partners Eplan and Rittal have a shared philosophy: To make complex things simple. Our solutions speed up your processes and boost your productivity. We optimise and industrialise every stage in your value chain and across the entire process – from design, planning and engineering, procurement and manufacturing through to operation and IT. With our help, you can triumph in the industrial transformation to the new Industry 4.0 standard.

Our goal:

Yesterday, we devised the solutions our customers will need tomorrow, and are already stocking them today.

Rittal and Eplan. Your partners for the future.

We think in terms of your processes.

Operations

Engineering

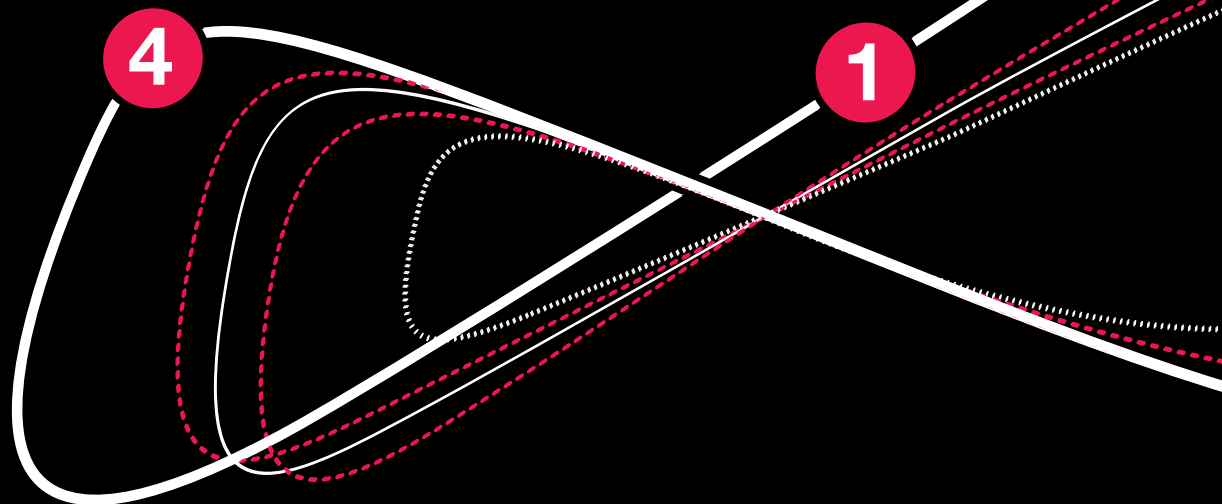

Supply

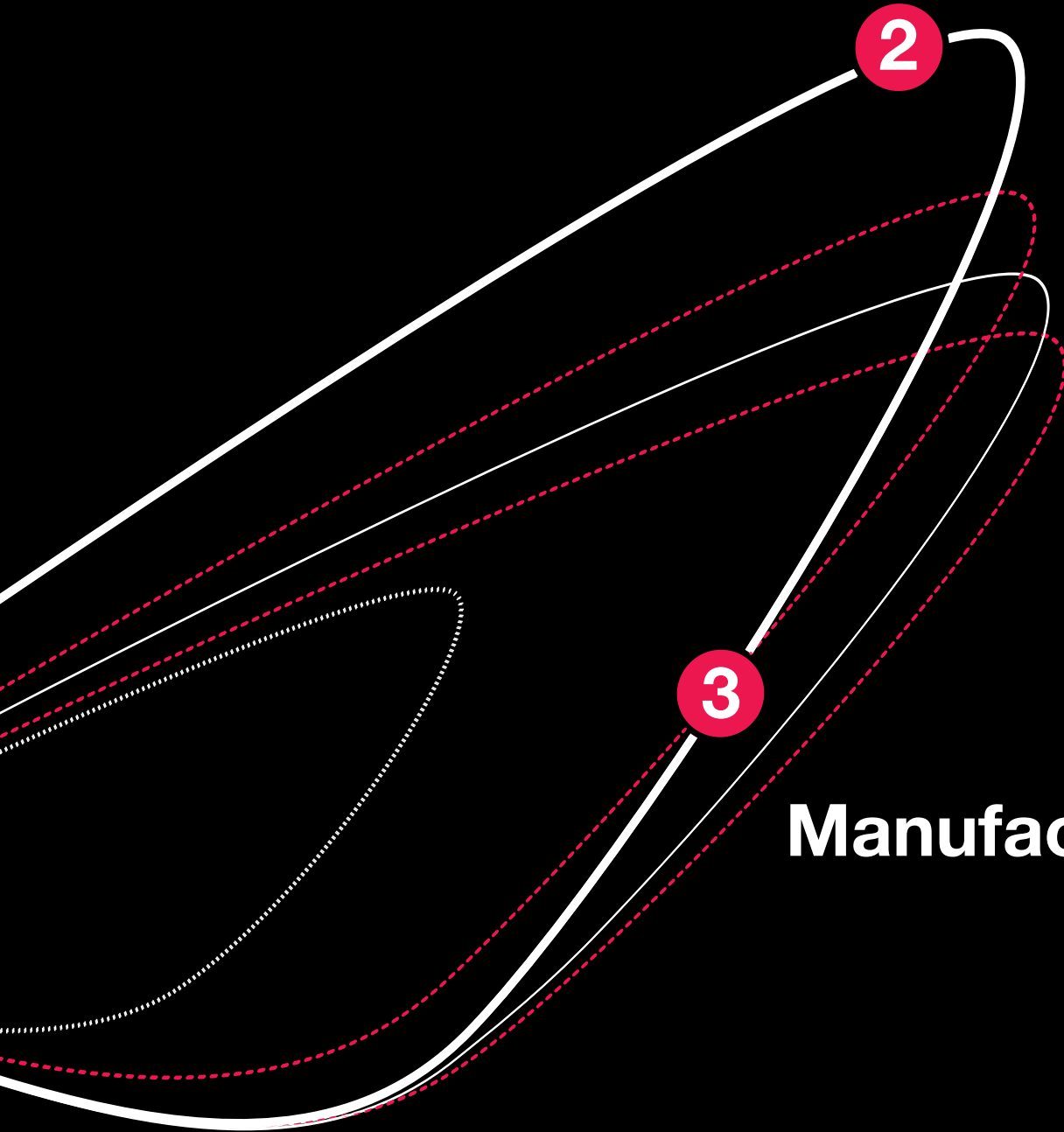

Manufacturing





RiPanel – your cutting-edge tool for straightforward enclosure system configuration. Effortlessly meet individual requirements with RiPanel. Below you will find an overview of all functions.

- Effortlessly select a matching enclosure system with the user-friendly interface
- Plausibility-checked, error-free selection of accessories with direct positioning in a realistic 3D view
- Add customer-specific cut-outs and import CAD data for precise renderings
- Automatically generate technical data for uncomplicated enquiries and orders

Discover RiPanel's efficiency and precision and optimise your enclosure configurations today.

Your benefits

- Save time with simple configuration and ordering processes
- Avoid errors when selecting and machining accessories
- Enhance your planning with a concurrent parts list and transparent price display
- Accelerate processes with integrated interfaces to Eplan and Rittal software

Rittal ePOCKET



Streamline your processes and maintenance operations with Rittal ePOCKET – your digital wiring plan pocket for efficient plant documentation.

Design and documentation:

- Fast, reliable documentation is available for all project participants
- Digital processes from wiring plan generation to the Rittal ePOCKET for immediate availability
- Fast change management with the integrated EPLAN eVIEW workflow
- Save on printing costs and minimise your carbon footprint
- Up-to-date data is available to all project participants

Service and maintenance:

- Save time on maintenance and repairs by rapidly locating the information you need
- Faster troubleshooting through simple pinpointing of the correct enclosure on site
- Reduced plant downtime and maintenance costs
- Correct documentation reduces the risk of error
- Minimised risk of fire (because no paper is stored inside the enclosure)
- Up-to-date data is available to all project participants
- Continuous tracking of changes by the maintenance engineers

Compact enclosures AX

Stainless steel

The AX stainless steel enclosure from Rittal represents significant progress in enclosure manufacturing. This high-quality stainless steel (1.4301 or 1.4404) enclosure delivers unprecedented robustness and resilience. Its smooth surface is easy to clean while ensuring maximum protection for sensitive components.

The AX stainless steel enclosure adapts to your individual requirements. Whether you are looking to protect high-quality components or streamline your interior installation and maintenance, this enclosure guarantees flexibility without compromising on safety.

Discover how the AX stainless steel enclosure can exceed your expectations and shape the future of enclosure manufacturing.

Interior installation flexibility

Integrated locators in the housing enable the precise, time-saving incorporation of the interior installation rails used to fit out enclosures with punched sections with mounting flanges and accessories from Rittal.

Interior installation reliability

The continuous pattern of locators is extremely flexible and the interior installation rail can be fitted in the enclosure without drilling, even retrospectively.



Security

The deliberately slimline enclosure edge fold provides broad, secure contact with the seamless PU foam seal and helps preserve the protection category (up to IP 66) and protection class IK 10.



Extension accessories

The optional perforated door strip with system punchings on a flexible 25 mm pitch pattern allows it to be extended quickly and easily without machining the door. Its compatibility with Rittal system accessories makes this possible.



Easy assembly

Tool-free door assembly saves even more time. Once the door has been positioned, the hinge pin simply needs to be pressed in to complete the process.



Ease of assembly and attachment of the mounting plate

The mounting plate is easy to pre-attach and secure firmly in place simply by inserting it from above. The printed pitch pattern provided as standard makes component assembly easier.



Straightforward earthing

The machined keyhole makes it much easier to earth the mounting plate with automatic potential equalisation and this can even be done after the mounting plate has been screwed into place.

Robust material
Stainless steel enclosures in 1.4301 and 1.4404 are exceptionally robust and corrosion-resistant. The smooth surface can be cleaned quickly and easily.



Simple machining and protection during transportation
The laser-resistant protective film applied as standard prevents the enclosure from becoming scratched during machining and subsequent transportation.



Easy wall-mounting
Preparing to mount the wall bracket is now much easier, thanks to the rear panel embossing with punch points.

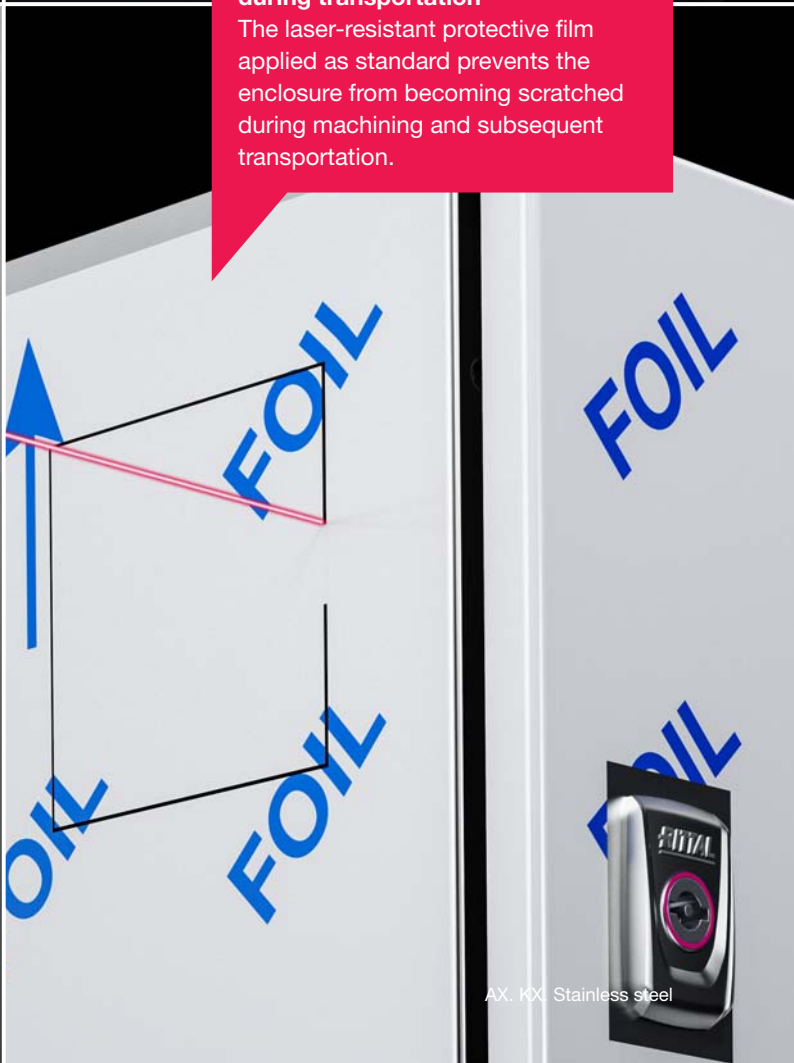

Compact enclosures AX

Basic enclosure AX, stainless steel



System accessories Page 24

Material:

- Enclosure: Stainless steel
- Door: Stainless steel, all-round foamed-in PU seal
- Mounting plate: Sheet steel
- Lock: Die-cast zinc, nickel-plated, double-bit insert die-cast zinc

Surface finish:

- Enclosure and door: Brushed, grain size 400
- Mounting plate: Zinc-plated

Supply includes:

- Enclosure with door(s)
 - Mounting plate
 - Lock: 3 mm double-bit
- Please note the product-specific scope of supply.

Approvals:

- UL
 - cUL
- Further approvals can be found on the Internet.

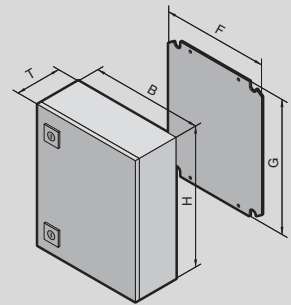

Compact enclosures AX

Basic enclosure AX, stainless steel

Width (B) mm	Packs of	300	300	Page
Height (H) mm		300	380	
Depth (T) mm		210	210	
Mounting plate width (F) mm		250	250	
Mounting plate height (G) mm		275	355	
Material	Stainless steel 1.4301 (AISI 304)	■	■	
	Stainless steel 1.4404 (AISI 316L)	-	-	
Model No.	1 pc(s).	1003.000	1005.000	
Weight, approx. kg		6.52	7.52	
IP protection category to IEC 60 529		IP 66	IP 66	
Protection category NEMA		NEMA 4X	NEMA 4X	
Product-specific scope of supply				
Door(s)		1	1	
Cam lock		1	1	
3-point locking system		-	-	
Accessories				
Wall mounting bracket, for AX stainless steel, KX stainless steel, wall distance 20 mm	4 pc(s).	2433.010	2433.000	32
Wall angle, stainless steel 1.4301	4 pc(s).	2583.010	2583.010	32
Pole clamp	2 pc(s).	2584.100	2584.100	33
Rail for interior installation	4 pc(s).	2394.210	2394.210	34
Base configuration rail AX	4 pc(s).	2394.100	2394.100	38
Punched section with mounting flange 14 x 39 mm, installation in the height		-	-	
Punched section with mounting flange 14 x 39 mm, installation in the door		-	-	
Punched section with mounting flange 23 x 64 mm, installation in the height	4 pc(s).	8617.100	-	38
Support strips		-	-	
LED system light		-	-	
Comfort handle AX for lock inserts or profile half-cylinders		-	-	
Mini-comfort handle AX for lock inserts or profile half-cylinders	1 pc(s).	2537.100	2537.100	27
Cam lock AX with double-bit insert, stainless steel 1.4404 (AISI 316L)	1 pc(s).	2304.100	2304.100	28
Lock inserts		see page	see page	27
Perforated door strip		-	-	
Sheet steel wiring plan pockets, width-variable		-	-	
Plastic wiring plan pockets		see page	see page	30
Wiring plan pockets with transparent pouch		see page	see page	30
Protective roof	1 pc(s).	2476.010	2476.010	31
Earth straps		see page	see page	43
Baying kit	1 pc(s).	1199.100	1199.100	25
Cable gland, brass M12 x 1.5	15 pc(s).	2411.801	2411.801	47
Cable gland, brass M16 x 1.5	15 pc(s).	2411.811	2411.811	47
Cable gland, brass M20 x 1.5	10 pc(s).	2411.821	2411.821	47
Cable gland, brass M25 x 1.5	10 pc(s).	2411.831	2411.831	47
Cable gland, brass M32 x 1.5	5 pc(s).	2411.841	2411.841	47
Cable gland, brass M40 x 1.5	4 pc(s).	2411.851	2411.851	47
Cable gland, brass M50 x 1.5	2 pc(s).	2411.861	2411.861	47
Cable gland, brass M63 x 1.5	1 pc(s).	2411.871	2411.871	47
Cable gland, polyamide M12 x 1.5	50 pc(s).	2411.601	2411.601	47
Cable gland, polyamide M16 x 1.5	50 pc(s).	2411.611	2411.611	47
Cable gland, polyamide M20 x 1.5	50 pc(s).	2411.621	2411.621	47
Cable gland, polyamide M25 x 1.5	25 pc(s).	2411.631	2411.631	47
Cable gland, polyamide M32 x 1.5	15 pc(s).	2411.641	2411.641	47
Cable gland, polyamide M40 x 1.5	5 pc(s).	2411.651	2411.651	47
Cable gland, polyamide M50 x 1.5	5 pc(s).	2411.661	2411.661	47
Cable gland, polyamide M63 x 1.5	3 pc(s).	2411.671	2411.671	47

Compact enclosures AX

Basic enclosure AX, stainless steel

Width (B) mm	Packs of	300	380	380	380	380	400	Page
Height (H) mm		380	300	380	380	600	500	
Depth (T) mm		210	210	210	210	210	210	
Mounting plate width (F) mm		250	330	330	330	330	350	
Mounting plate height (G) mm		355	275	355	355	575	475	
Material	Stainless steel 1.4301 (AISI 304)	–	■	■	–	■	■	
	Stainless steel 1.4404 (AISI 316L)	■	–	–	■	–	–	
Model No.	1 pc(s).	1302.000	1011.000	1006.000	1303.000	1008.000	1015.000	
Weight, approx. kg		8.4	8.4	9.12	9.8	15.1	12.9	
IP protection category to IEC 60 529		IP 66	IP 66	IP 66	IP 66	IP 66	IP 66	
Protection category NEMA		NEMA 4X	NEMA 4X	NEMA 4X	NEMA 4X	NEMA 4X	NEMA 4X	
Product-specific scope of supply								
Door(s)		1	1	1	1	1	1	
Cam lock		1	1	1	1	2	2	
3-point locking system		–	–	–	–	–	–	
Accessories								
Wall mounting bracket, for AX stainless steel, KX stainless steel, wall distance 20 mm	4 pc(s).	2433.510	2433.000	2433.000	2433.510	2433.000	2433.000	32
Wall angle, stainless steel 1.4301	4 pc(s).	2583.010	2583.010	2583.010	2583.010	2583.010	2583.010	32
Pole clamp	2 pc(s).	2584.100	2584.100	2584.100	2584.100	2584.100	2584.100	33
Rail for interior installation	4 pc(s).	2394.210	2394.210	2394.210	2394.210	2394.210	2394.210	34
Base configuration rail AX	4 pc(s).	2394.100	2394.100	2394.100	2394.100	2394.100	2394.100	38
Punched section with mounting flange 14 x 39 mm, installation in the height	4 pc(s).	–	–	–	–	8619.720	8619.710	37
Punched section with mounting flange 14 x 39 mm, installation in the door		–	–	–	–	–	–	
Punched section with mounting flange 23 x 64 mm, installation in the height	4 pc(s).	–	8617.100	–	–	8617.130	8617.120	38
Support strips		–	–	–	–	–	–	
LED system light		–	–	–	–	–	2500.100	48
Comfort handle AX for lock inserts or profile half-cylinders		–	–	–	–	–	–	
Mini-comfort handle AX for lock inserts or profile half-cylinders	1 pc(s).	2537.100	2537.100	2537.100	2537.100	2537.100	2537.100	27
Cam lock AX with double-bit insert, stainless steel 1.4404 (AISI 316L)	1 pc(s).	2304.100	2304.100	2304.100	2304.100	2304.100	2304.100	28
Lock inserts		see page	see page	see page	see page	see page	see page	27
Perforated door strip		–	–	–	–	–	–	
Sheet steel wiring plan pockets, width-variable	1 pc(s).	–	–	–	–	–	2515.200	30
Plastic wiring plan pockets		see page	see page	see page	see page	see page	see page	30
Wiring plan pockets with transparent pouch		see page	see page	see page	see page	see page	see page	30
Protective roof	1 pc(s).	2476.010	2472.010	2472.010	2472.010	2472.010	–	31
Earth straps		see page	see page	see page	see page	see page	see page	43
Baying kit	1 pc(s).	1199.100	1199.100	1199.100	1199.100	1199.100	1199.100	25
Cable gland, brass M12 x 1.5	15 pc(s).	2411.801	2411.801	2411.801	2411.801	2411.801	2411.801	47
Cable gland, brass M16 x 1.5	15 pc(s).	2411.811	2411.811	2411.811	2411.811	2411.811	2411.811	47
Cable gland, brass M20 x 1.5	10 pc(s).	2411.821	2411.821	2411.821	2411.821	2411.821	2411.821	47
Cable gland, brass M25 x 1.5	10 pc(s).	2411.831	2411.831	2411.831	2411.831	2411.831	2411.831	47
Cable gland, brass M32 x 1.5	5 pc(s).	2411.841	2411.841	2411.841	2411.841	2411.841	2411.841	47
Cable gland, brass M40 x 1.5	4 pc(s).	2411.851	2411.851	2411.851	2411.851	2411.851	2411.851	47
Cable gland, brass M50 x 1.5	2 pc(s).	2411.861	2411.861	2411.861	2411.861	2411.861	2411.861	47
Cable gland, brass M63 x 1.5	1 pc(s).	2411.871	2411.871	2411.871	2411.871	2411.871	2411.871	47
Cable gland, polyamide M12 x 1.5	50 pc(s).	2411.601	2411.601	2411.601	2411.601	2411.601	2411.601	47
Cable gland, polyamide M16 x 1.5	50 pc(s).	2411.611	2411.611	2411.611	2411.611	2411.611	2411.611	47
Cable gland, polyamide M20 x 1.5	50 pc(s).	2411.621	2411.621	2411.621	2411.621	2411.621	2411.621	47
Cable gland, polyamide M25 x 1.5	25 pc(s).	2411.631	2411.631	2411.631	2411.631	2411.631	2411.631	47
Cable gland, polyamide M32 x 1.5	15 pc(s).	2411.641	2411.641	2411.641	2411.641	2411.641	2411.641	47
Cable gland, polyamide M40 x 1.5	5 pc(s).	2411.651	2411.651	2411.651	2411.651	2411.651	2411.651	47
Cable gland, polyamide M50 x 1.5	5 pc(s).	2411.661	2411.661	2411.661	2411.661	2411.661	2411.661	47
Cable gland, polyamide M63 x 1.5	3 pc(s).	2411.671	2411.671	2411.671	2411.671	2411.671	2411.671	47

Compact enclosures AX

Basic enclosure AX, stainless steel

Width (B) mm	Packs of	500	500	600	600	600	600	Page
Height (H) mm		500	500	380	600	600	760	
Depth (T) mm		210	300	210	210	210	210	
Mounting plate width (F) mm		450	450	550	550	550	550	
Mounting plate height (G) mm		475	475	355	575	575	735	
Material	Stainless steel 1.4301 (AISI 304)	■	■	■	■	–	■	
	Stainless steel 1.4404 (AISI 316L)	–	–	–	–	■	–	
Model No.	1 pc(s).	1007.000	1013.000	1009.000	1010.000	1304.000	1012.000	
Weight, approx. kg		16.6	18.4	13.9	20.1	23.5	28.6	
IP protection category to IEC 60 529		IP 66	IP 66	IP 66	IP 66	IP 66	IP 66	
Protection category NEMA		NEMA 4X	NEMA 4X	NEMA 4X	NEMA 4X	NEMA 4X	NEMA 4X	
Product-specific scope of supply								
Door(s)		1	1	1	1	1	1	
Cam lock		2	2	1	2	2	2	
3-point locking system		–	–	–	–	–	–	
Accessories								
Wall mounting bracket, for AX stainless steel, KX stainless steel, wall distance 20 mm	4 pc(s).	2433.100	2433.100	2433.100	2433.100	2433.510	2433.100	32
Wall angle, stainless steel 1.4301	4 pc(s).	2583.010	2583.010	2583.010	2583.010	2583.010	2583.010	32
Pole clamp	2 pc(s).	2584.100	2584.100	2584.100	2584.100	2584.100	2584.100	33
Base configuration rail AX	4 pc(s).	2394.100	2394.100	2394.100	2394.100	2394.100	2394.100	38
Rail for interior installation	4 pc(s).	2394.210	2394.210	2394.210	2394.210	2394.210	2394.210	34
Punched section with mounting flange 14 x 39 mm, installation in the height	4 pc(s).	8619.710	8619.710	–	8619.720	8619.720	–	37
Punched section with mounting flange 14 x 39 mm, installation in the door		–	–	–	–	–	–	
Punched section with mounting flange 23 x 64 mm, installation in the height	4 pc(s).	8617.120	8617.120	–	8617.130	8617.130	–	38
Support strips	20 pc(s).	–	–	–	–	–	4696.000	29
LED system light	1 pc(s).	2500.100	2500.100	2500.100	2500.100	2500.100	2500.100	48
Comfort handle AX for lock inserts or profile half-cylinders		–	–	–	–	–	–	
Mini-comfort handle AX for lock inserts or profile half-cylinders	1 pc(s).	2537.100	2537.100	2537.100	2537.100	2537.100	2537.100	27
Cam lock AX with double-bit insert, stainless steel 1.4404 (AISI 316L)	1 pc(s).	2304.100	2304.100	2304.100	2304.100	2304.100	2304.100	28
Lock inserts		see page	see page	see page	see page	see page	see page	27
Perforated door strip	2 pc(s).	–	–	–	–	–	2311.076	29
Sheet steel wiring plan pockets, width-variable	1 pc(s).	2515.200	2515.200	2515.300	2515.300	2515.300	2515.300	30
Plastic wiring plan pockets		see page	see page	see page	see page	see page	see page	30
Wiring plan pockets with transparent pouch		see page	see page	see page	see page	see page	see page	30
Protective roof	1 pc(s).	2362.010	–	2473.010	2473.010	2473.010	2473.010	31
Earth straps		see page	see page	see page	see page	see page	see page	43
Baying kit	1 pc(s).	1199.100	1199.100	1199.100	1199.100	1199.100	1199.100	25
Cable gland, brass M12 x 1.5	15 pc(s).	2411.801	2411.801	2411.801	2411.801	2411.801	2411.801	47
Cable gland, brass M16 x 1.5	15 pc(s).	2411.811	2411.811	2411.811	2411.811	2411.811	2411.811	47
Cable gland, brass M20 x 1.5	10 pc(s).	2411.821	2411.821	2411.821	2411.821	2411.821	2411.821	47
Cable gland, brass M25 x 1.5	10 pc(s).	2411.831	2411.831	2411.831	2411.831	2411.831	2411.831	47
Cable gland, brass M32 x 1.5	5 pc(s).	2411.841	2411.841	2411.841	2411.841	2411.841	2411.841	47
Cable gland, brass M40 x 1.5	4 pc(s).	2411.851	2411.851	2411.851	2411.851	2411.851	2411.851	47
Cable gland, brass M50 x 1.5	2 pc(s).	2411.861	2411.861	2411.861	2411.861	2411.861	2411.861	47
Cable gland, brass M63 x 1.5	1 pc(s).	2411.871	2411.871	2411.871	2411.871	2411.871	2411.871	47
Cable gland, polyamide M12 x 1.5	50 pc(s).	2411.601	2411.601	2411.601	2411.601	2411.601	2411.601	47
Cable gland, polyamide M16 x 1.5	50 pc(s).	2411.611	2411.611	2411.611	2411.611	2411.611	2411.611	47
Cable gland, polyamide M20 x 1.5	50 pc(s).	2411.621	2411.621	2411.621	2411.621	2411.621	2411.621	47
Cable gland, polyamide M25 x 1.5	25 pc(s).	2411.631	2411.631	2411.631	2411.631	2411.631	2411.631	47
Cable gland, polyamide M32 x 1.5	15 pc(s).	2411.641	2411.641	2411.641	2411.641	2411.641	2411.641	47
Cable gland, polyamide M40 x 1.5	5 pc(s).	2411.651	2411.651	2411.651	2411.651	2411.651	2411.651	47
Cable gland, polyamide M50 x 1.5	5 pc(s).	2411.661	2411.661	2411.661	2411.661	2411.661	2411.661	47
Cable gland, polyamide M63 x 1.5	3 pc(s).	2411.671	2411.671	2411.671	2411.671	2411.671	2411.671	47

Compact enclosures AX

Basic enclosure AX, stainless steel

Width (B) mm	Packs of	760	800	800	1000	1000	1000	Page
Height (H) mm		760	1000	1200	1000	1200	1200	
Depth (T) mm		300	300	300	300	300	300	
Mounting plate width (F) mm		705	745	745	945	945	945	
Mounting plate height (G) mm		735	975	1175	975	1175	1175	
Material	Stainless steel 1.4301 (AISI 304)	■	■	■	■	■	–	
	Stainless steel 1.4404 (AISI 316L)	–	–	–	–	–	■	
Model No.	1 pc(s).	1014.000	1016.000	1017.000	1018.000	1019.000	1305.000	
Weight, approx. kg		39.5	54.6	61.0	70.9	78.0	76.0	
IP protection category to IEC 60 529		IP 66	IP 66	IP 66	IP 55	IP 55	IP 55	
Protection category NEMA		NEMA 4X	NEMA 4X	NEMA 4X	NEMA 12	NEMA 12	NEMA 12	
Product-specific scope of supply								
Door(s)		1	1	1	2	2	2	
Cam lock		2	2	–	2	–	–	
3-point locking system		–	–	–	–	–	–	
Accessories								
Wall mounting bracket, for AX stainless steel, KX stainless steel, wall distance 20 mm	4 pc(s).	2433.010	2433.010	2433.010	2433.010	2433.010	2433.510	32
Wall angle, stainless steel 1.4301	4 pc(s).	2583.010	2583.010	2583.010	2583.010	2583.010	2583.010	32
Pole clamp	2 pc(s).	2584.100	2584.100	2584.100	2584.100	2584.100	2584.100	33
Base configuration rail AX	4 pc(s).	2394.100	2394.100	2394.100	2394.100	2394.100	2394.100	38
Rail for interior installation	4 pc(s).	2394.300	2394.300	2394.300	2394.300	2394.300	2394.300	34
Punched section with mounting flange 14 x 39 mm, installation in the height	4 pc(s).	8619.790	8619.750	8619.770	8619.750	8619.770	8619.770	37
Punched section with mounting flange 14 x 39 mm, installation in the door	4 pc(s).	–	–	8619.730	–	8619.710	8619.710	37
Punched section with mounting flange 23 x 64 mm, installation in the height	4 pc(s).	–	8617.150	8617.160	8617.150	8617.160	8617.160	38
Support strips	20 pc(s).	4599.200	4697.000	4697.000	4695.000	4695.000	4695.000	29
LED system light	1 pc(s).	2500.110	2500.110	2500.110	2500.110	2500.110	2500.110	48
Comfort handle AX for lock inserts or profile half-cylinders	1 pc(s).	–	–	2435.100	–	2435.100	2435.100	26
Mini-comfort handle AX for lock inserts or profile half-cylinders	1 pc(s).	2537.100	2537.100	–	2537.100	–	–	27
Cam lock AX with double-bit insert, stainless steel 1.4404 (AISI 316L)	1 pc(s).	2304.100	2304.100	2304.100	2304.100	–	2304.100	28
Lock inserts		see page	see page	see page	see page	see page	see page	27
Perforated door strip	2 pc(s).	2311.076	2311.100	2311.120	2311.100	2311.120	2311.120	29
Sheet steel wiring plan pockets, width-variable	1 pc(s).	2515.400	2515.400	2515.400	2515.200	2515.200	2515.200	30
Plastic wiring plan pockets		see page	see page	see page	see page	see page	see page	30
Wiring plan pockets with transparent pouch		see page	see page	see page	see page	see page	see page	30
Protective roof	1 pc(s).	2474.010	2475.010	2475.010	2363.010	2363.010	2363.010	31
Earth straps		see page	see page	see page	see page	see page	see page	43
Baying kit	1 pc(s).	1199.100	1199.100	1199.100	1199.100	1199.100	1199.100	25
Cable gland, brass M12 x 1.5	15 pc(s).	2411.801	2411.801	2411.801	2411.801	2411.801	2411.801	47
Cable gland, brass M16 x 1.5	15 pc(s).	2411.811	2411.811	2411.811	2411.811	2411.811	2411.811	47
Cable gland, brass M20 x 1.5	10 pc(s).	2411.821	2411.821	2411.821	2411.821	2411.821	2411.821	47
Cable gland, brass M25 x 1.5	10 pc(s).	2411.831	2411.831	2411.831	2411.831	2411.831	2411.831	47
Cable gland, brass M32 x 1.5	5 pc(s).	2411.841	2411.841	2411.841	2411.841	2411.841	2411.841	47
Cable gland, brass M40 x 1.5	4 pc(s).	2411.851	2411.851	2411.851	2411.851	2411.851	2411.851	47
Cable gland, brass M50 x 1.5	2 pc(s).	2411.861	2411.861	2411.861	2411.861	2411.861	2411.861	47
Cable gland, brass M63 x 1.5	1 pc(s).	2411.871	2411.871	2411.871	2411.871	2411.871	2411.871	47
Cable gland, polyamide M12 x 1.5	50 pc(s).	2411.601	2411.601	2411.601	2411.601	2411.601	2411.601	47
Cable gland, polyamide M16 x 1.5	50 pc(s).	2411.611	2411.611	2411.611	2411.611	2411.611	2411.611	47
Cable gland, polyamide M20 x 1.5	50 pc(s).	2411.621	2411.621	2411.621	2411.621	2411.621	2411.621	47
Cable gland, polyamide M25 x 1.5	25 pc(s).	2411.631	2411.631	2411.631	2411.631	2411.631	2411.631	47
Cable gland, polyamide M32 x 1.5	15 pc(s).	2411.641	2411.641	2411.641	2411.641	2411.641	2411.641	47
Cable gland, polyamide M40 x 1.5	5 pc(s).	2411.651	2411.651	2411.651	2411.651	2411.651	2411.651	47
Cable gland, polyamide M50 x 1.5	5 pc(s).	2411.661	2411.661	2411.661	2411.661	2411.661	2411.661	47
Cable gland, polyamide M63 x 1.5	3 pc(s).	2411.671	2411.671	2411.671	2411.671	2411.671	2411.671	47

Small enclosures KX

Stainless steel

At the heart of challenging industrial installations and harsh environments, the KX stainless steel enclosure combines unrivalled quality with exceptional reliability. In a world where protection and safety are paramount, the KX stainless steel enclosure is your trusted partner. Precision-manufactured from high-end materials, these small enclosures will withstand even the toughest conditions, whether industrial installations or challenging environments. The innovative design and first-class stainless steel material creates an enclosure that is not just robust but also exceptionally long-lasting.

This brochure will guide you through the key features that set the KX stainless steel enclosure apart, from the optimised quick-release fastener with Torx insert for terminal boxes and bus enclosures, to simplified earthing and 180° door hinging.

Discover how the KX stainless steel enclosure delivers reliable performance and remarkable versatility in even the most challenging situations.



Terminal box KX

- Quick-release fastener including Torx insert
- Rear panel embossing: Wall bracket
- Earthing: Optimised perforated mounting strip
- Interior installation: Support rails, mounting plate, mounting claw



E-Box KX

- Cam lock
- Rear panel embossing: Wall bracket
- Earthing: Optimised perforated mounting strip
- 180° hinges as standard



Bus enclosures KX

- Quick-release fastener including Torx insert
- Rear panel embossing: Wall bracket
- Earthing: Optimised perforated mounting strip
- Interior installation: Support rails, mounting plate, mounting claw
- Hinges 180° as standard

**Terminal box KX, bus enclosure KX:
Precision**

The quick-release fastener with Torx insert is quickly and easily fitted, for tight all-round sealing of the lid against the enclosure.



E-Box KX: Clearance

The 180° door hinges create more space and improve access to the enclosure interior.

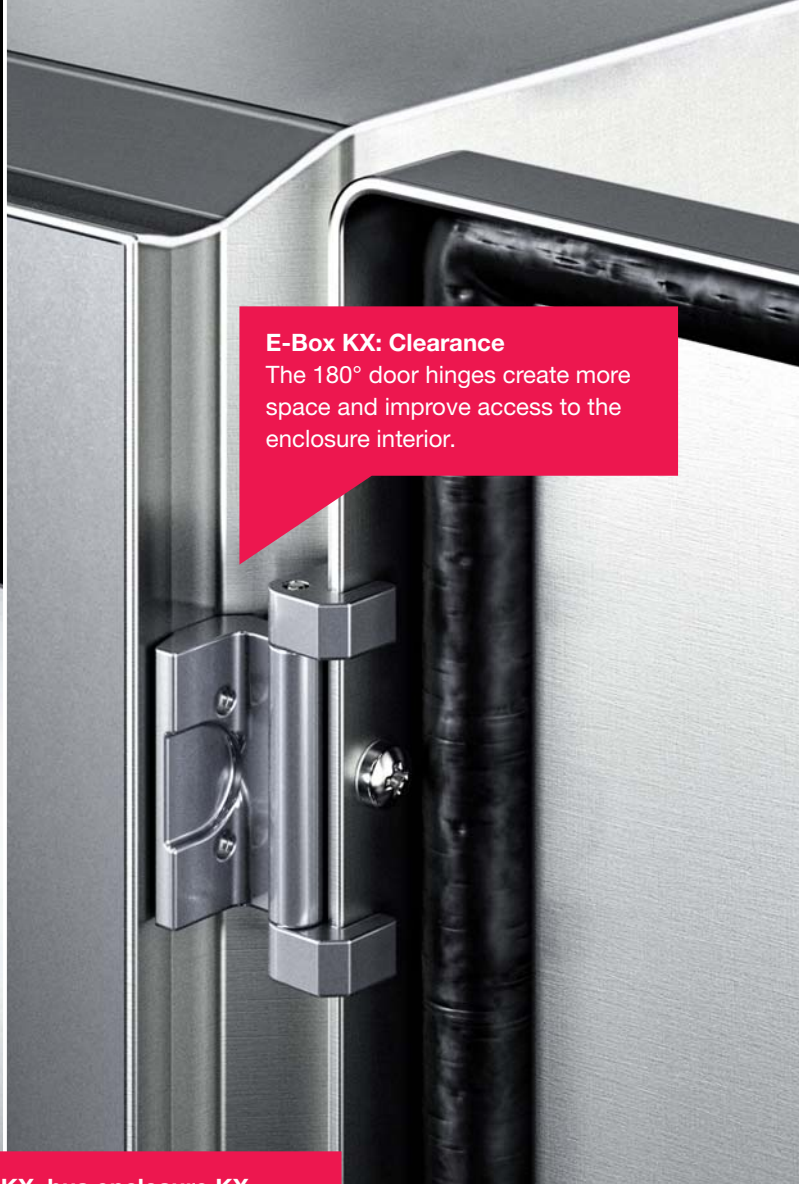

**Terminal box KX, bus enclosure KX,
E-Box KX: Secure earthing**

Optimised side elements for the PE conductor connection ensure super-fast, user-friendly earthing, even retrospectively.





Bus enclosure KX: Access

The wide door opening angle of up to 180° gives you plenty of space to fit and replace modules quickly and easily.



Bus enclosure KX, terminal box KX: Space maximisation

The support rails can optionally be fitted on the front of the integrated perforated mounting strip or, to maximise the enclosure depth, directly onto the rear wall of the rack.



Terminal box KX, bus enclosure KX, E-Box KX: Easy wall-mounting

Preparing to mount the wall bracket is now much easier, thanks to the rear panel embossing with punch points.



E-Box KX: Reliability

The cam lock with double-bit insert is fitted without tools. It securely locks the enclosure and can also be incorporated into custom locking systems.

Terminal boxes KX, stainless steel



System accessories Page 24

Material:

- Enclosures: Stainless steel 1.4301 (AISI 304)
- Cover: Stainless steel 1.4301 (AISI 304), all-round foamed-in PU seal

Surface finish:

- Enclosure and cover: Brushed, grain size 180

Protection category IP to IEC 60 529:

- IP 66

Protection category NEMA:

- NEMA 4X

Supply includes:

- Enclosure with cover
- Quick-release fasteners with Torx insert

Approvals:

- UL
- cUL

Further approvals can be found on the Internet.

Terminal boxes KX, stainless steel

Width mm	Packs of	150	150	300	200	200	Page
Height mm		150	150	150	200	200	
Depth mm		80	120	80	80	120	
Material thickness – enclosure mm		1.25	1.25	1.25	1.25	1.25	
Material thickness – cover mm		1.25	1.25	1.25	1.25	1.25	
Model No.	1 pc(s).	1560.000	1564.000	1561.000	1562.000	1565.000	
Weight, approx. kg		1.33	1.54	1.94	1.9	2.5	
Quick-release fastener		4	4	4	4	4	
Accessories							
Wall mounting bracket, for AX stainless steel, KX stainless steel	4 pc(s).	1594.010	1594.010	1594.010	1594.010	1594.010	31
Wall angle	4 pc(s).	–	–	2583.010	2583.010	2583.010	32
Pole clamp	2 pc(s).	2584.100	2584.100	2584.100	2584.100	2584.100	33
Mounting plates	1 pc(s).	1560.800	1560.800	1561.800	1562.800	1562.800	33
Support rails TH 35/7.5	10 pc(s).	2314.000	2314.000	2316.000	2315.000	2315.000	39
Mounting clip for support rails	30 pc(s).	2309.000	2309.000	2309.000	2309.000	2309.000	40
Mounting bracket	4 pc(s).	4597.000	4597.000	4597.000	4597.000	4597.000	40
Rail mounting bracket	20 pc(s).	2365.000	2366.000	2365.000	2365.000	2366.000	41
Mounting claw for second mounting level	20 pc(s).	2309.100	2309.100	2309.100	2309.100	2309.100	40
Cover hinge, stainless steel	2 pc(s).	1592.010	1592.010	1592.010	1592.010	1592.010	25
Earth straps	5 pc(s).	2565.100	2565.050	2565.100	2565.100	2565.050	43
Baying kit	1 pc(s).	–	1199.100	–	–	1199.100	25
Pressure relief stoppers, stainless steel	5 pc(s).	4000.300	4000.300	4000.300	4000.300	4000.300	24
Condensate discharge	6 pc(s).	2459.000	2459.000	2459.000	2459.000	2459.000	24
Self-tapping screws	300 pc(s).	2487.000	2487.000	2487.000	2487.000	2487.000	41

Small enclosures KX

Terminal boxes KX, stainless steel

Width mm	Packs of	300	300	400	300	400	Page
Height mm		200	200	200	300	300	
Depth mm		80	120	120	120	120	
Material thickness – enclosure mm		1.25	1.25	1.25	1.25	1.25	
Material thickness – cover mm		1.25	1.25	1.25	1.25	1.25	
Model No.	1 pc(s).	1563.000	1566.000	1568.000	1567.000	1569.000	
Weight, approx. kg		2.28	2.81	3.6	3.74	4.6	
Quick-release fastener		4	4	4	4	4	
Accessories							
Wall mounting bracket, for AX stainless steel, KX stainless steel	4 pc(s).	1594.010	1594.010	1594.010	1594.010	1594.010	31
Wall angle	4 pc(s).	2583.010	2583.010	2583.010	2583.010	2583.010	32
Pole clamp	2 pc(s).	2584.100	2584.100	2584.100	2584.100	2584.100	33
Mounting plates	1 pc(s).	1563.800	1563.800	1564.800	1567.800	1568.800	33
Support rails TH 35/7.5	10 pc(s).	2316.000	2316.000	2317.000	2316.000	2317.000	39
Mounting clip for support rails	30 pc(s).	2309.000	2309.000	2309.000	2309.000	2309.000	40
Mounting bracket	4 pc(s).	4597.000	4597.000	4597.000	4597.000	4597.000	40
Rail mounting bracket	20 pc(s).	2365.000	2366.000	2366.000	2366.000	2366.000	41
Mounting claw for second mounting level	20 pc(s).	2309.100	2309.100	2309.100	2309.100	2309.100	40
Cover hinge, stainless steel	2 pc(s).	1592.010	1592.010	1592.010	1592.010	1592.010	25
Earth straps	5 pc(s).	2565.100	2565.050	2565.050	2565.050	2565.050	43
Baying kit	1 pc(s).	–	1199.100	1199.100	1199.100	1199.100	25
Pressure relief stoppers, stainless steel	5 pc(s).	4000.300	4000.300	4000.300	4000.300	4000.300	24
Condensate discharge	6 pc(s).	2459.000	2459.000	2459.000	2459.000	2459.000	24
Self-tapping screws	300 pc(s).	2487.000	2487.000	2487.000	2487.000	2487.000	41

E-Box KX, stainless steel



System accessories Page 24

Material:

- Enclosure: Stainless steel
- Door: Stainless steel, all-round foamed-in PU seal
- Mounting plate: Sheet steel

Surface finish:

- Enclosure and door: Brushed, grain size 180
- Mounting plate: Zinc-plated

Protection category IP to IEC 60 529:

- IP 66

Protection category NEMA:

- NEMA 4X

Supply includes:

- Enclosure with door
- Mounting plate
- Cam lock with 3 mm double-bit insert

Approvals:

- UL
- cUL

Further approvals can be found on the Internet.

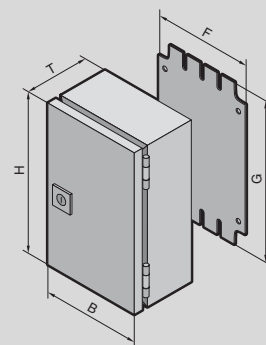

Small enclosures KX

E-Box KX, stainless steel, depth 120/155 mm

Width (B) mm	Packs of	200	200	200	380	Page
Height (H) mm		300	300	300	300	
Depth (T) mm		120	155	155	155	
Mounting plate width (F) mm		175	175	175	365	
Mounting plate height (G) mm		285	285	285	275	
Material	Stainless steel 1.4301 (AISI 304)	■	■	–	■	
	Stainless steel 1.4404 (AISI 316L)	–	–	■	–	
Material thickness – enclosure mm		1.25	1.25	1.5	1.25	
Material thickness – door mm		1.25	1.25	1.5	1.25	
Model No.	1 pc(s).	1584.000	1587.000	1301.000	1588.000	
Weight, approx. kg		3.6	4.1	4.62	7.14	

Accessories						
Wall mounting bracket, for AX stainless steel, KX stainless steel	4 pc(s).	1594.010	1594.010	1594.010	1594.010	32
Pole clamp	2 pc(s).	2584.100	2584.100	2584.100	2584.100	33
Support rails TH 35/7.5	10 pc(s).	2315.000	2315.000	2315.000	2317.000 ¹⁾	39
Mounting clip for support rails	30 pc(s).	2309.000	2309.000	2309.000	2309.000	40
Mounting bracket	4 pc(s).	4597.000	4597.000	4597.000	4597.000	40
Rail mounting bracket	20 pc(s).	2366.000	2366.000	2366.000	2366.000	41
Mini-comfort handle AX for lock inserts or profile half-cylinders	1 pc(s).	2537.100	2537.100	2537.100	2537.100	27
Mini-comfort handle AX with security lock insert, lock E1	1 pc(s).	2537.200	2537.200	2537.200	2537.200	27
Mini-comfort handle AX for padlocks and lock inserts or profile half-cylinders	1 pc(s).	2537.300	2537.300	2537.300	2537.300	27
Cam lock AX with double-bit insert, stainless steel 1.4404 (AISI 316L)	1 pc(s).	2309.110	2309.110	2309.110	2309.110	28
Lock insert 7 mm square	1 pc(s).	2460.000	2460.000	2460.000	2460.000	27
Lock insert 8 mm square	1 pc(s).	2461.000	2461.000	2461.000	2461.000	27
Lock insert 7 mm triangular	1 pc(s).	2462.000	2462.000	2462.000	2462.000	27
Lock insert 8 mm triangular	1 pc(s).	2463.000	2463.000	2463.000	2463.000	27
Lock insert, screwdriver	1 pc(s).	2464.000	2464.000	2464.000	2464.000	27
Lock insert Daimler	1 pc(s).	2465.000	2465.000	2465.000	2465.000	27
Lock insert 3 mm double-bit	1 pc(s).	2466.000	2466.000	2466.000	2466.000	27
Lock insert Fiat	1 pc(s).	2307.000	2307.000	2307.000	2307.000	27
Lock insert 6.5 mm triangular	1 pc(s).	2460.650	2460.650	2460.650	2460.650	27
Earth straps	5 pc(s).	2565.050	2565.050	2565.050	2565.050	43
Pressure relief stoppers, stainless steel	5 pc(s).	4000.300	4000.300	4000.300	4000.300	24
Condensate discharge	6 pc(s).	2459.000	2459.000	2459.000	2459.000	24
Self-tapping screws	300 pc(s).	2487.000	2487.000	2487.000	2487.000	41

¹⁾ Must be cut to length accordingly

Bus enclosures KX, stainless steel



System accessories Page 24

Material:

- Enclosures: Stainless steel 1.4301 (AISI 304)
- Cover: Stainless steel 1.4301 (AISI 304), all-round foamed-in PU seal
- Hinges: Die-cast zinc

Surface finish:

- Enclosure and cover: Brushed, grain size 180

Protection category IP to IEC 60 529:

- IP 66

Protection category NEMA:

- NEMA 4X

Supply includes:

- Enclosure with hinged cover
- Quick-release fastener with Torx insert

Approvals:

- UL
 - cUL
- Further approvals can be found on the Internet.

Bus enclosures KX, stainless steel

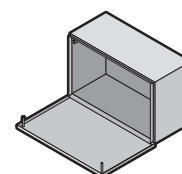
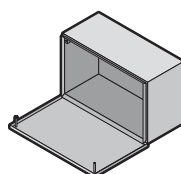

	Packs of	400	600	Page
Width mm		400	600	
Height mm		200	200	
Depth mm		120	120	
Material thickness – enclosure mm		1.25	1.25	
Material thickness – cover mm		1.25	1.25	
Model No.	1 pc(s).	1585.000	1586.000	
Weight, approx. kg		3.92	5.65	

Accessories

Wall mounting bracket, for AX stainless steel, KX stainless steel	4 pc(s).	1594.010	1594.010	31
Wall angle	4 pc(s).	–	2583.010	32
Pole clamp	2 pc(s).	2584.100	2584.100	33
Mounting plates	1 pc(s).	1564.800	1566.800	33
Support rails TH 35/7.5	10 pc(s).	2317.000	–	39
Support rails TH 35/15	10 pc(s).	–	2319.000	39
Mounting clip for support rails	30 pc(s).	2309.000	2309.000	40
Mounting bracket	4 pc(s).	4597.000	4597.000	40
Rail mounting bracket	20 pc(s).	2366.000	2366.000	41
Mounting claw for second mounting level	20 pc(s).	2309.100	2309.100	40
Earth straps	5 pc(s).	2565.050	2565.050	43
Baying kit	1 pc(s).	1199.100	1199.100	25
Pressure relief stoppers, stainless steel	5 pc(s).	4000.300	4000.300	24
Condensate discharge	6 pc(s).	2459.000	2459.000	24
Self-tapping screws	300 pc(s).	2487.000	2487.000	41

System accessories AX, KX

Base



Pressure relief stopper

Especially when enclosures are exposed to changing climatic conditions, pressure differences may cause condensation to form in sealed enclosures. The integral sealing membrane in the pressure relief stopper largely prevents such pressure differences and hence eliminates condensation; additionally, it also prevents the ingress of moisture from the outside. Installed in vertical surfaces to protect against dirt.

Technical specifications:

- Air permeability up to 120 litres/hour with a pressure difference of 70 mbar
- Connection thread M12 x 1.5
- For fitting in wall thicknesses up to 4 mm

Packs of	Model No.
5 pc(s).	2459.500

Material:

- Polyamide

Colour:

- Similar to RAL 9005

Protection category IP to IEC 60 529:

- IP 68

Protection category IP to DIN 40 040-9:

- IP 69K

Supply includes:

- Lock nut



Pressure relief stopper, stainless steel

Especially when enclosures are exposed to changing climatic conditions, pressure differences may cause condensation to form in sealed enclosures. The integral sealing membrane in the pressure relief stopper largely prevents such pressure differences and hence eliminates condensation; additionally, it also prevents the ingress of moisture from the outside. Installed in vertical surfaces to protect against dirt.

Technical specifications:

- Length 10 mm
- Connection thread M12 x 1.5
- Air permeability up to 60 litres/hour with a pressure difference of 70 mbar

Material:

- Stainless steel 1.4301 (AISI 304)

Type rating to UL 50E:

- Type 4X
- Type 13

IP protection category to IEC 60 529

- IP 66
- IP X8
- IP X9

Supply includes:

- Lock nut

Packs of	Model No.
5 pc(s).	4000.300



Condensate discharge

For reliable condensate discharge from the inside and protection against splashed water from the outside (labyrinth effect). A hole diameter of 16 mm is required.

Material:

- Polyamide

Colour:

- Similar to RAL 7035

Protection category:

- Protection from splashed water, when correctly installed at the bottom

Note:

- Additional holes required in the enclosure

Packs of	Model No.
6 pc(s).	2459.000

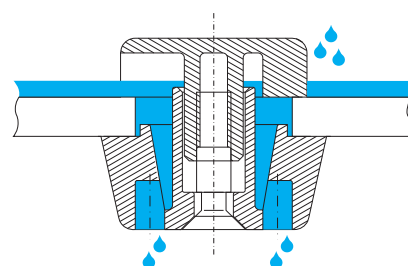

System accessories AX, KX

Baying/Hinges

Baying kit

for AX, KX

For baying AX/KX enclosures. The additional cut-outs are to be provided by the customer.

Special screws and nuts

- For fast, simple assembly without thread-tapping
- Compression of the seal is limited to a predefined level, to ensure a long-lasting, permanent seal between enclosures

Seal, self-adhesive

- Comprised of bayable sealing elements and corner pieces, for individual adaptation to various enclosure sizes

One pack is sufficient for a baying point up to H x D = 800 x 350 mm.

Packs of	Model No.
1 pc(s).	1199.100

Supply includes:

- Special screws and nuts
- Sealing elements, self-adhesive



Cover hinge

for terminal boxes KX, stainless steel

The cover hinge is simply screw-fastened to the enclosure protection channel and to the edge fold.

Supply includes:

- Assembly parts

Material	Packs of	Model No.
Stainless steel 1.4404 (AISI 316L)	2 pc(s).	1592.010



System accessories AX

Lock system



Comfort handle AX

for compact enclosures AX with 3-point lock system

Prepared for the installation of lock inserts or for the installation of standard commercially available 40 or 45 mm profile half-cylinders, as well as lock and push-button inserts. The unlatched handle folds out forwards, and swivels to open the lock.

Material:

- Precision-cast stainless steel

	
	For lock inserts or profile half-cylinders
	Model No.
Precision-cast stainless steel	2435.300
Lock inserts, type A	
7 mm square	2460.000
8 mm square	2461.000
7 mm triangular	2462.000
8 mm triangular	2463.000
Screwdriver	2464.000
Daimler insert	2465.000
3 mm double-bit	2466.000
Fiat	2307.000
6,5 mm triangular	2460.650
Lock and push-button inserts	
Lock insert, lock no. 3524 E ¹⁾	2467.000
Push-button insert	2468.000
Push-button and lock insert ¹⁾	2469.000 ²⁾
Profile half-cylinders	
to DIN 18 252 ³⁾	9785.040
	9785.042 ⁴⁾

¹⁾ With two keys

²⁾ Lock no. 2123; no other lock is possible

³⁾ With 3 keys for each lock insert

⁴⁾ Packs of two, simultaneous locking within the same pack, no simultaneous locking for different packs

System accessories AX

Lock system

Mini-comfort handle AX

for AX with cam lock, KX with cam lock



Prepared for the installation of lock inserts or for the installation of standard commercially available 40 or 45 mm profile half-cylinders, as well as lock and push-button inserts. The lock is opened by swivelling the unlocked handle.

Material:

– Die-cast zinc

Surface finish:

– Powder-coated

		
	For lock inserts or profile half-cylinders	For padlocks and lock inserts or profile half-cylinders
	Model No.	Model No.
RAL 7035	2537.100	2537.300
Lock inserts, type A		
7 mm square	2460.000	2460.000
8 mm square	2461.000	2461.000
7 mm triangular	2462.000	2462.000
8 mm triangular	2463.000	2463.000
Screwdriver	2464.000	2464.000
Daimler insert	2465.000	2465.000
3 mm double-bit	2466.000	2466.000
Fiat	2307.000	2307.000
6.5 mm triangular	2460.650	2460.650
Lock and push-button inserts		
Lock insert, lock no. 3524 E ¹⁾	2467.000	2467.000
Push-button insert	2468.000	2468.000
Push-button and lock insert ²⁾	2469.000 ²⁾	2469.000 ²⁾
Profile half-cylinders		
to DIN 18 252 ³⁾	9785.040	9785.040 ⁵⁾
	9785.042 ⁴⁾	9785.042 ⁴⁾

¹⁾ With two keys

²⁾ Lock no. 2123; no other lock is possible

³⁾ With 3 keys for each lock insert

⁴⁾ Packs of two, simultaneous locking within the same pack, no simultaneous locking for different packs

⁵⁾ Different closures





Lock inserts

for installation in comfort handle AX, mini-comfort handle AX

Material:

– Die-cast zinc

		
	Model No.	
Lock insert, lock no. 3524 E ¹⁾	2467.000	–
Push-button insert	2468.000	–
Push-button and lock insert ¹⁾	2469.000²⁾	–
Profile half-cylinders to DIN 18 252 ³⁾	–	9785.040
	–	9785.042⁴⁾

¹⁾ With two keys

²⁾ Lock no. 2123; no other lock is possible

³⁾ With 3 keys for each lock insert

⁴⁾ Packs of two, simultaneous locking within the same pack, no simultaneous locking for different packs



System accessories AX

Lock system



Lock inserts

- For
- AX with cam lock
 - AX with 3-point lock system
 - Comfort handle AX
 - Mini-comfort handle AX

Material:

- Die-cast zinc

Type A, length 27 mm	Model No.
7 mm square	2460.000
8 mm square	2461.000
7 mm triangular	2462.000
8 mm triangular	2463.000
Screwdriver	2464.000
Daimler insert	2465.000
3 mm double-bit	2466.000
Fiat	2307.000
6.5 mm triangular	2460.650

Cam lock, stainless steel

for AX, KX E-Box
With double-bit insert

Material:

- Made entirely from stainless steel 1.4404 (AISI 316L)

For	Packs of	Model No.
AX	1 pc(s).	2304.100
KX E-Box	1 pc(s).	2309.110

Enclosure key

For lock inserts. Enclosure, case and lock systems are supplied as standard with matching keys.

	Model No.			
	-	-	2549.000³⁾	2549.500²⁾
Double-bit no. 5	2531.000	-	-	-
Security lock no. 3524 E	-	2532.000¹⁾	-	-
7 mm triangular	2545.000	-	-	-
8 mm triangular	2546.000	-	-	-
7 mm square	2547.000	-	-	-
8 mm square	2548.000	-	-	-
for Daimler	2521.000	-	-	-
for Fiat	2308.000	-	-	-

¹⁾ Packs of 2

²⁾ With bit adaptor and reversible bit for: Multi-tooth size 25 and 30

³⁾ Incl. slotted screwdriver attachment

System accessories AX, KX

Door installation

Support strips

for door installation, for AX

For attachment of

- Cable ducts
- Cable conduit holder
- Equipment installed on the door
- Cable clamping and attachment

4.5 mm diameter hole on a 25 mm DIN pitch pattern

Installation options:

- In the AX enclosure door with cam lock

Material:

- Sheet steel

Surface finish:

- Zinc-plated

Supply includes:

- Assembly parts

For door width mm	Length mm	Packs of	Model No.
600	540	20 pc(s).	4696.000
760	700	20 pc(s).	4599.200
800	740	20 pc(s).	4697.000



Also required:

- For installation in AX stainless steel:
AX perforated door strip, stainless steel, see page 29



Accessories:

- Screws and self-tapping screws M5, see page 41



Punched section with mounting flange, 14 x 39 mm

for door installation, for AX

For the attachment of

- Cable ducts
- Cable conduit holder
- Equipment installed on the door, etc.

Installation options:

- In the AX enclosure door with 3-point lock system

Material:

- Sheet steel

Surface finish:

- Zinc-plated

Supply includes:

- Assembly parts

For door width mm	Distance between attachment points mm	Packs of	Model No.
800	675	4 pc(s).	8619.730
1000	375	4 pc(s).	8619.710
1200	475	4 pc(s).	8619.720



Also required:

- For installation in AX stainless steel:
AX perforated door strip, stainless steel, see page 29



Accessories:

- Screws and self-tapping screws M5 for configuring the customer's own components on the punched section with mounting flange, see page 41



Perforated door strip

for AX stainless steel

For vertical mounting on the threaded bolts of the door.

For attachment of

- Support strips
- Punched sections with mounting flanges, 14 x 39 mm
- Door stay

Material:

- Sheet steel

Surface finish:

- Zinc-plated

For door height mm	Packs of	Model No.
760	2 pc(s).	2311.076
1000	2 pc(s).	2311.100
1200	2 pc(s).	2311.120



Accessories:

- Support strips, see page 29
- Punched section with mounting flange, 14 x 39 mm, see page 29
- Door stay, see page 30
- Screws, see page 41



System accessories AX, KX

Door installation



Storage box

For fixing to all flat, clean surfaces with double-sided adhesive tape. Secure storage of CDs/DVDs, small parts such as fuses etc.

Capacity:

- Max. 10 CDs/DVDs

Material:

- Polyamide

Packs of	Model No.
1 pc(s).	2446.000

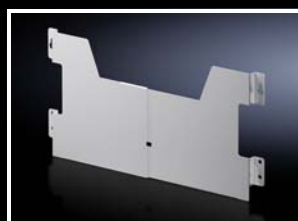

Wiring plan pockets, sheet steel

width-variable, for AX

For fastening to the perforated door strip at any height. Variable and easily adjustable in the width.

Depth: 35 mm

Colour:

- RAL 7035

Supply includes:

- Assembly screws

To fit door width mm	Clearance opening mm		Model No.
	Width	Height	
600	475 – 575	210	2515.300
760, 800	625 – 725	210	2515.400



Also required:

- For installation in AX stainless steel: AX perforated door strip, stainless steel, see page 29



Plastic wiring plan pockets

For adhering to surfaces.

Material:

- Polystyrene with self-adhesive fastening strips

Colour:

- Similar to RAL 7035

For format	Clearance opening mm			Model No.
	W	H	D	
A3 landscape	438	286	45	2513.000
A4 portrait	228	254	17	2514.000
A5 landscape	228	174	17	2515.000



Wiring plan pockets with transparent pouch

With welded-on transparent pouch and self-adhesive backing.

For format	Model No.
A4	2510.000
A3	2512.000



Door stay AX

To secure the door in the open position. May be fitted without machining the enclosure.

Supply includes:

- Assembly parts

For	Mounting	Packs of	Model No.
AX stainless steel	top	1 pc(s).	2519.110



Also required:

- For installation in AX stainless steel: AX perforated door strip, stainless steel, see page 29

System accessories AX, KX

Roof/wall mounting

Protective roof

for AX

Installation options:

- Secured with adhesive; no need for machining
- May also be screw-fastened for dynamic loads

Material:

- Stainless steel 1.4301 (AISI 304)

Surface finish:

- Brushed, grain size 240

Supply includes:

- Assembly parts

For		H mm	Model No.
Enclosure width mm	Enclosure depth T mm		
300	210	37	2361.010
380	210	37	2472.010
500	210	37	2362.010
600	210	37	2473.010
760	300	43	2474.010
800	300	43	2475.010
1000	300	43	2363.010



Side view

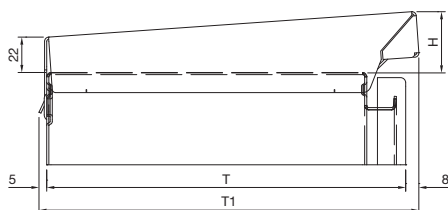

$$T1 = \text{Enclosure depth } T + 13 \text{ mm}$$

Rear view

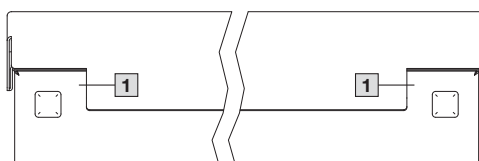

1 Recess for wall mounting bracket

Dust guard trim

for AX, KX

To protect against deposits on the upper edge of the door and between the enclosure and the door/cover. Cut the dust guard trim to length according to the enclosure width. Drill the enclosure and fit the dust guard trim using the adhesive strips and screws.

Material:

- Plastic, UV-resistant

Colour:

- Similar to RAL 7024

Length mm	Model No.
1200	2426.500



Wall mounting bracket

for AX stainless steel, KX stainless steel

For the attachment of AX and KX stainless steel enclosures.

Supply includes:

- Assembly parts

Note:

- For hygiene reasons, and in view of the protection category, the stainless steel enclosures do not have any drilled holes for the wall mounting bracket

Material	Wall distance mm	Packs of	Model No.
Stainless steel 1.4301 (AISI 304)	10	4 pc(s).	1594.010



System accessories AX, KX

Wall mounting bracket



Wall mounting bracket

for AX stainless steel, KX stainless steel

For the attachment of AX and KX stainless steel enclosures.

Benefits:

- Simply suspend the wall-mounted bracket from a screw in the wall
- Different mounting positions allow the wall mounting bracket to be tailored to local conditions on site
- If necessary, the support may be finished with a stylish cover cap

Supply includes:

- Wall mounting bracket
- Cover cap
- Assembly parts

Note:

- For hygiene reasons, and in view of the protection category, the stainless steel enclosures do not have any drilled holes for the wall mounting brackets

Material	Wall distance mm	Packs of	Model No.
Stainless steel 1.4301 (AISI 304)	20	4 pc(s).	2433.010
Stainless steel 1.4404 (AISI 316L)	20	4 pc(s).	2433.510

Wall angle

for AX, KX

For the attachment of sheet steel and stainless steel enclosures.

Supply includes:

- Assembly parts for mounting on the enclosure

Note:

- Additional holes required in the enclosure

Material	Colour	Packs of	Model No.
Stainless steel 1.4301 (AISI 304)	-	4 pc(s).	2583.010

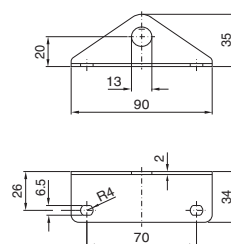

System accessories AX, KX

Wall mounting/Interior installation

Pole clamp

for AX, KX

For reliable, convenient fastening to round or square poles.

For pole diameter / size:

- Ø from 40 to 170 mm
- □ from 50 to 150 mm

Material:

- Mounting angles, clamping section: Sheet steel
- Clamping strap: Stainless steel 1.4301 (AISI 304)

Surface finish:

- Mounting angle, clamping section: Zinc-plated

Supply includes:

- 2 mounting angles, 600 mm long
- 4 clamping sections
- 2 clamping straps
- 4 clamping brackets
- 4 self-tapping M10 bolts for mounting onto the enclosure

Packs of	Model No.
2 pc(s).	2584.100



Mounting plates

for terminal boxes KX, bus enclosures KX

For component installation outside of the enclosure. Assembly screws included as accessories with the enclosure.

Material:

- Sheet steel, 2 mm

Surface finish:

- Zinc-plated



Accessories:

- Self-tapping screws 2487.000, see page 41



Possible alternative:

- Support rails, see page 39

For size mm	For Model No.	Model No.
150 x 150	1560.000, 1564.000	1560.800
300 x 150	1561.000	1561.800
200 x 200	1565.000, 1562.000	1562.800
300 x 200	1563.000, 1566.000	1563.800
400 x 200	1568.000, 1585.000	1564.800
600 x 200	1586.000	1566.800
300 x 300	1567.000	1567.800
400 x 300	1569.000	1568.800



System accessories AX, KX

Interior installation

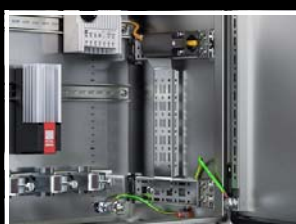

Rail for interior installation AX

For mounting in the enclosure, no machining required.

Variable with 2 rows of system punchings, creates additional mounting space e.g. for:

- Enclosure lights
- Door-operated switch
- Door stay
- Punched sections with mounting flanges, 14 x 39 mm
- Punched sections with mounting flanges, 23 x 64 mm
- Cable conduit holder
- Cable clamp rails
- Support rails

Benefits:

- Increased load-bearing capacity
- Stable mounting of the rail inside the enclosure
- Including adaptor for door-operated switch
- Compatible with VX25 accessories in conjunction with AX base configuration rail
- Enclosure protection category is retained (no machining required)
- Automatic potential equalisation
- May be retro-fitted even with the mounting plate in situ

Material:

- Sheet steel

Surface finish:

- Zinc-plated

For enclosure depth mm	Packs of	Model No.
210	4 pc(s).	2394.210
300	4 pc(s).	2394.300



Also required:

- For installing the LED system light: Mounting bracket for interior installation, see page 40
- For mounting VX support rails, VX cable clamp rails and VX punched sections with mounting flanges 23 x 64 mm: AX base configuration rail, see page 38

System accessories AX, KX

Interior installation

AX configuration examples: Rail for interior installation

1 Rail for interior installation AX		Page
For enclosure depth mm		
	210	2394.210
	300	2394.300

AX configuration examples: Interior installation of the enclosure

For enclosure width/height mm	Installation in the enclosure height				Installation in the enclosure width			
	2 Support strip		3 Punched section with mounting flange, 14 x 39 mm		4 Support strip		5 Punched section with mounting flange, 14 x 39 mm	
	Model No.	Page	Model No.	Page	Model No.	Page	Model No.	Page
300	-		-		4594.000		8619.700	
380	-		-		-		-	
400	-		-		4309.000		8619.710	
500	4309.000		8619.710		4596.000		8619.720	
600	4596.000	29	8619.720	37	8800.130	29	8619.760	37
760	-		8619.790		-		-	
800	-		-		4579.000		8619.740	
1000	4599.000		8619.750		-		-	
1200	-		8619.770		-		-	

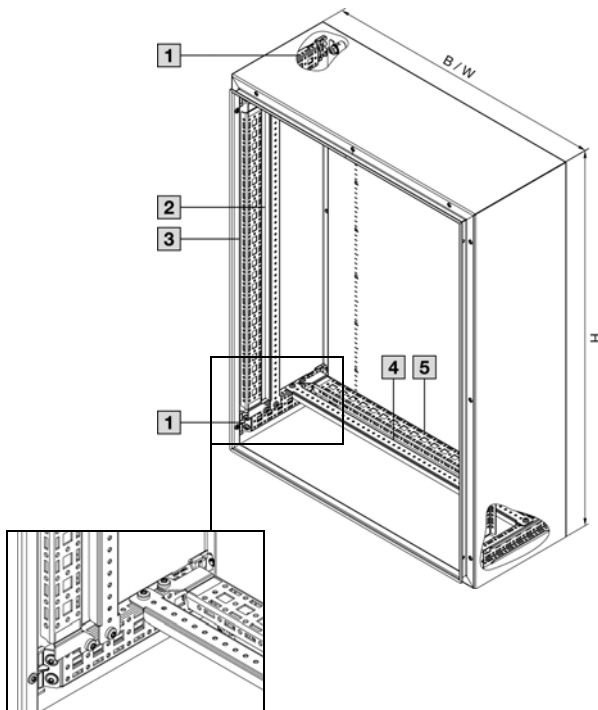

System accessories AX, KX

Interior installation

AX configuration examples: Interior installation with base configuration rail

[6] AX base configuration rail combined with an interior installation rail	Page
Model No. 2394.100	38

For enclosure width/height mm	Installation in the enclosure height		Installation in the enclosure width					
	[7] Punched section with mounting flange, 23 x 64 mm	[8] Punched section with mounting flange, 23 x 64 mm	[9] Support rail, 48 x 26 mm	[10] Cable clamp rail				
	Model No.	Page	Model No.	Page	Model No.	Page	Model No.	Page
300	8617.100	38	8617.100	38	–	38	–	39
380	–		–		–			
400	–		8617.110		–		8619.400	
500	8617.120		8617.120		–		–	
600	8617.130		8617.130		8617.800		8619.410	
700	–		–		–		–	
760	–		–		–		–	
800	–		8617.140		8617.810		8619.420	
1000	8617.150		8617.150		8617.820		8619.430	
1200	8617.160		–		–		–	

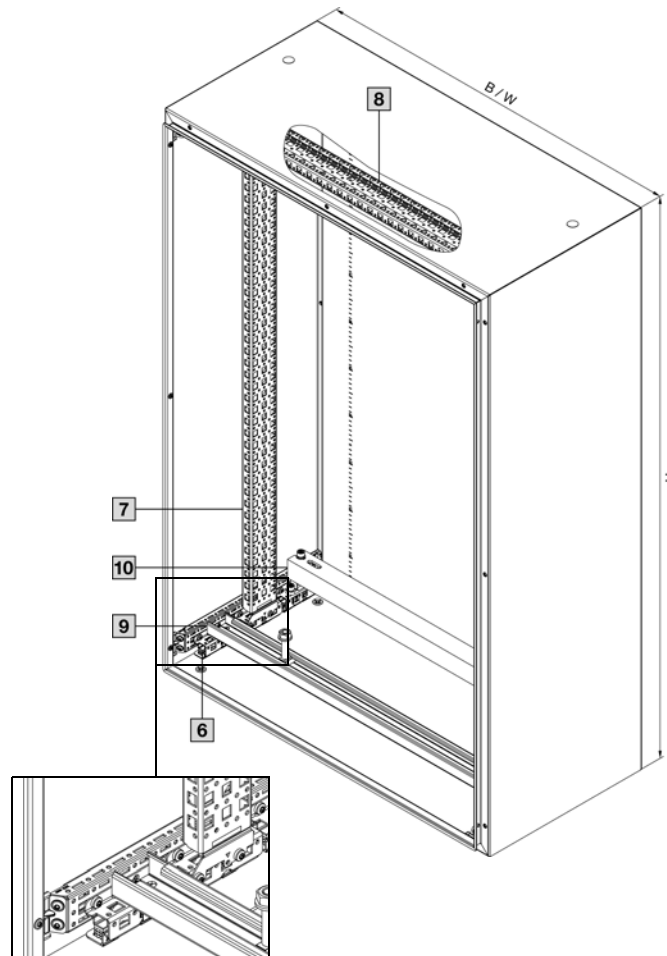

System accessories AX, KX

Rail systems

Punched section with mounting flange, 14 x 39 mm

for AX

Interior installation in the enclosure height and width
Locates securely onto the interior installation rail AX.

For the attachment of

- Cable ducts
- Cable conduit holder

Material:

- Sheet steel

Surface finish:

- Zinc-plated

Supply includes:

- Assembly parts

For enclosure height/width mm	Distance between attachment points mm	Packs of	Model No.	
			Installation in the enclosure height	Installation in the enclosure width
300	175	4 pc(s).	-	8619.700
400	275	4 pc(s).	-	8619.710
500	375	4 pc(s).	8619.710	8619.720
600	475	4 pc(s).	8619.720	8619.760
760	635	4 pc(s).	8619.790	-
800	675	4 pc(s).	-	8619.740
1000	875	4 pc(s).	8619.750	-
1200	1075	4 pc(s).	8619.770	-



Also required:

- Interior installation rail AX 2394.XXX for configuration in the enclosure height and width, see page 34



Accessories:

- Screws and self-tapping screws M5 for configuring the customer's own components on the punched section with mounting flange, see page 41



Support strips

for AX

For simple interior installation in the enclosure height and width.

Material:

- Sheet steel

Surface finish:

- Zinc-plated

Supply includes:

- Assembly parts

For enclosure height/width mm	Packs of	Model No.	
		Installation in the enclosure height	Installation in the enclosure width
300	20 pc(s).	-	4594.000
400	20 pc(s).	-	4309.000
500	20 pc(s).	4309.000	4596.000
600	20 pc(s).	4596.000	8800.130
800	20 pc(s).	-	4579.000
1000	20 pc(s).	4599.000	-



Also required:

- Rail for interior installation AX 2394.XXX, see page 34



Accessories:

- Screws, see Catalogue 36, page 1004
- Cable ties 2597.000, see Catalogue 36, page 1061



System accessories AX, KX

Rail systems



Base configuration rail AX

For installation in AX enclosures in combination with the AX interior installation rail.

- For the installation of VX accessories such as:
- VX support rail, 48 x 26 mm
 - VX cable clamp rail
 - VX punched section with mounting flange, 23 x 64 mm

Material:

- Sheet steel

Surface finish:

- Zinc-plated



Punched section with mounting flange, 23 x 64 mm

For variable, individual interior installation. Simply secure to the interior installation rail above the base configuration rail in the AX. System punchings on all four sides. With slots at the top and bottom for cage nuts, for attaching your own components via metric screws.

Installation options:

- In the width and height of the AX in conjunction with the AX interior installation rail and AX base configuration rail

Material:

- Sheet steel

Surface finish:

- Zinc-plated

Supply includes:

- Assembly parts

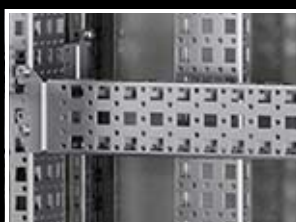

Support rail 48 x 26 mm

For heavy installed equipment such as transformers. T-head screw and slots in the support rail accommodate all mounting dimensions.

Installation options:

- In the width of the AX in conjunction with the AX interior installation rail and AX base configuration rail

Material:

- Sheet steel

Surface finish:

- Zinc-plated

Supply includes:

- Assembly parts



Length mm	Packs of	Model No.
99	4 pc(s).	2394.100

! Also required:

- Rail for interior installation AX 2394.XXX, see page 34

For enclosure height/width mm	Packs of	Model No.
300	4 pc(s).	8617.100
400	4 pc(s).	8617.110
500	4 pc(s).	8617.120
600	4 pc(s).	8617.130
800	4 pc(s).	8617.140
1000	4 pc(s).	8617.150
1200	4 pc(s).	8617.160

! Also required:

- For AX: AX interior installation rail 2394.XXX, see page 34 and AX base configuration rail, see page 38

+ Accessories:

- Screws, see page 41
- Cable ties 2597.000, see Catalogue 36, page 1061
- Cage nuts M5 4166.500, M6 4164.500, M8 4165.500, see Catalogue 36, page 1002

Configuration examples, see page 36

For enclosure width mm	Packs of	Model No.
600	2 pc(s).	8617.800
800	2 pc(s).	8617.810
1000	2 pc(s).	8617.820

! Also required:

- For AX: AX interior installation rail 2394.XXX, see page 34 and AX base configuration rail, see page 38

+ Accessories:

- Punched section with mounting flange 23 x 64 mm for height-offset installation, see page 38

Configuration examples, see page 36

System accessories AX, KX

Rail systems

Cable clamp rail

Right angle section

For strain relief with cable entry. Depth-variable mounting on a 25 mm pitch pattern in the AX in conjunction with the interior installation rail and base configuration rail.

Material:

– Steel

Surface finish:

– Zinc-plated

Supply includes:

– Assembly parts

Enclosure width mm	Packs of	Model No.
400	2 pc(s).	8619.400
600	2 pc(s).	8619.410
800	2 pc(s).	8619.420
1000	2 pc(s).	8619.430



Also required:

– For AX: AX interior installation rail 2394.XXX, see page 34 and AX base configuration rail, see page 38

Configuration examples, see page 36



Cable clamp

for cable clamp rails

For fastening the cables to the cable clamp rails.

Material:

– Sheet steel

Surface finish:

– Zinc-plated

Supply includes:

– Plastic insert

For cable diameter mm	Packs of	Model No.
6 – 12	25 pc(s).	2350.000
12 – 16	25 pc(s).	2351.000
14 – 18	25 pc(s).	2352.000
18 – 22	25 pc(s).	2353.000
22 – 26	25 pc(s).	2354.000
26 – 30	25 pc(s).	2355.000
30 – 34	25 pc(s).	2356.000
34 – 38	25 pc(s).	2357.000
38 – 42	25 pc(s).	2358.000
42 – 46	25 pc(s).	2359.000
46 – 50	25 pc(s).	2360.000



Support rails TH 35/7.5 and TH 35/15

to EN 60 715 for AX, KX

Length sized to the enclosure width.

For enclosure width mm	Support rails length mm	Design	Packs of	Model No.
150	137	TH 35/7.5	10 pc(s).	2314.000
200	187		10 pc(s).	2315.000
300	287		10 pc(s).	2316.000
400	387		10 pc(s).	2317.000
500	487	TH 35/15	10 pc(s).	2318.000
600	587		10 pc(s).	2319.000



Support rails

to EN 60 715

Standard length: 2 m

Design	Length	Packs of	Model No.
TH 35/15	2 m	6 pc(s).	2313.150
TH 35/7.5	2 m	6 pc(s).	2313.750

System accessories AX, KX

Rail systems/assembly components



Mounting claw for second mounting level

for terminal boxes KX, bus enclosures KX

For fixing top hat rails directly onto the rear panel of KX terminal boxes and KX bus enclosures. Creates an additional mounting level with an extra 10 mm of installation depth without having to machine the enclosure.

Packs of	Model No.
20 pc(s).	2309.100

Accessories:

- Support rails TH 35/7.5 to EN 60 715, see page 39



Mounting clip

for support rails

For fast, secure attachment of:

- Cable ducts
 - Mounting plates
 - Mounting angles
- on support rail TH 35/7.5 and 35/15 to EN 60 715. Simply pre-assemble the mounting clip on the part to be installed, then snap into position on the support rail.

Packs of	Model No.
30 pc(s).	2309.000



Mounting bracket

Installation options:

- On all enclosures and mounting parts with system punchings on a 25 mm pitch pattern

Material:

- Sheet steel

Surface finish:

- Zinc-plated

Supply includes:

- Assembly screws

Packs of	Model No.
4 pc(s).	4597.000

Accessories:

- Screws, see page 41
- Cable ties 2597.000, see Catalogue 36, page 1061



Mounting bracket

for interior installation

In conjunction with the rail for interior installation, the mounting bracket allows the LED system light to be fitted without machining and without the use of tools.

Material:

- Sheet steel

Surface finish:

- Zinc-plated

Supply includes:

- Assembly parts

Packs of	Model No.
4 pc(s).	6205.100

Also required:

- Rail for interior installation AX 2394.XXX, see page 34



System accessories AX, KX

Assembly components

Rail mounting bracket

For individual mounting of rails at a distance from the mounting surface.

Material:

– Sheet steel, zinc-plated

Rail mounting bracket	Packs of	Model No.
Flat	20 pc(s).	2365.000
Inclined	20 pc(s).	2366.000

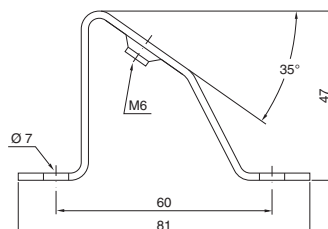
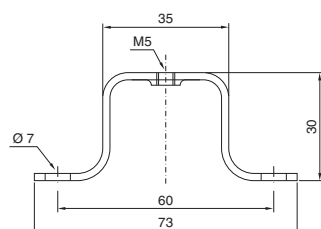

Metal multi-tooth screw

For the round holes Ø 4.5 mm in the enclosure section, punched rails and punched sections without mounting flanges.

Multi-tooth drive for optimum transmission of torques, an extended tool life and increased safety and reliability when tightening and loosening screw connections.

Type of screw	Dimensions mm	Packs of	Model No.
Metal multi-tooth screws	5.5 x 13	300 pc(s).	2486.600
Metal multi-tooth screws for stainless steel	5 x 13	300 pc(s).	2486.400
Self-tapping screws (hex screws)	M5 x 10	500 pc(s).	2504.000
Self-tapping screws	ST 4.8 x 16	300 pc(s).	2487.000



Self-tapping screw

For the round holes Ø 4.5 mm in the enclosure section, punched rails and punched sections without mounting flanges.



Self-tapping screw

Mark, drill and tighten in a single operation using electric or pneumatic tools.

For metal thickness: 0.8 – 3 mm
 Length: 16 mm
 Usable length: 9.5 mm
 Width across flats: 8 mm



Isolator cap

for screw head

To isolate screw heads within the cable duct.

Material:

– Plastic

Packs of	Model No.
100 pc(s).	8800.770



System accessories AX, KX

482.6 mm (19") installation system



Swing frame, small

for 600 and 800 mm wide compact enclosures AX
For mounting 482.6 mm (19") equipment.

Material:

- Sheet steel

Surface finish:

- Zinc-plated

Supply includes:

- Cam with double-bit lock insert and parts for attaching to the installation kit

Note:

- The swing frame stay 8619.270 is required to lock the open swing frame.



Accessories:

- 482.6 mm (19") fastener, 1 U, 2090.000

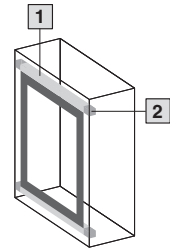

U	From enclosure height mm	Packs of	Model No.
3	380	1 pc(s).	8619.500
6	600	1 pc(s).	8619.510
9	600	1 pc(s).	8619.520
12	760	1 pc(s).	8619.530

Also required:

	For enclosure width mm		
1 Installation kit	600	1 pc(s).	8619.600
	800	1 pc(s).	8619.610
2 Mounting kit AX	600	4 pc(s).	2034.010
	800		

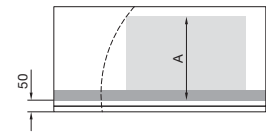
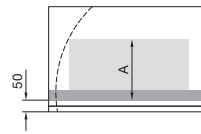

Enclosure dimensions mm		A = max. installation depth mm with internal mounting	
Width	Depth	Centre	Side
600	210	130	-
600	250	170	-
600	350	220	-
600	400	220	-
800	300	210	210
800	400	310	310



Installation kit

for swing frame, small
For mounting the small swing frame in compact enclosures AX.

Load capacity:

- Up to 1500 N

Material:

- Sheet steel

Surface finish:

- Nickel-plated

Supply includes:

- Assembly parts

For enclosure width mm	Packs of	Model No.
600	1 pc(s).	8619.600
800	1 pc(s).	8619.610



Also required:

- For mounting in compact enclosures AX:
Mounting kit AX



Mounting kit AX

for installation kit for swing frame, small
For mounting the small swing frame in compact enclosures AX.

Supply includes:

- 4 mounting brackets

Note:

- 1 pack is sufficient for mounting one small swing frame

Packs of	Model No.
4 pc(s).	2034.010

System accessories AX, KX

Earthing

Earth straps

For configuring a reliable earthing connection with perfect contact

- With ring terminals to match the earthing screws
- Length-optimised and ready to install



Also required:

- Assembly parts for earth straps, see Catalogue 36, page 1033

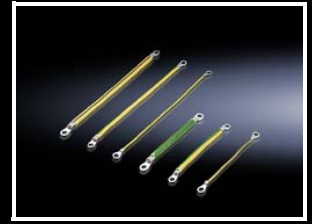

For AX enclosures

Connection option			Cross-section mm ²	Length mm	Packs of	Model No.
Door	Enclosure	Mounting plate				
M8	M8	M8	4	170	5 pc(s).	2564.000
			16	170	5 pc(s).	2565.000
			25	170	5 pc(s).	2566.000
			4	300	5 pc(s).	2567.000
			10	300	5 pc(s).	2565.120
			16	300	5 pc(s).	2568.000
			25	300	5 pc(s).	2569.000

For KX enclosures

Connection option			Cross-section mm ²	Length mm	Packs of	Model No.
Cover	Enclosure	Mounting plate				
M6	M6	M6	10	200	5 pc(s).	2565.100
M6	M6	M6	10	350	5 pc(s).	2565.050



System accessories AX, KX

ISV distribution enclosures, installation kits



ISV installation kit

for AX

For mounting ISV installation modules in the enclosure.

Material:

- Assembly kit: Sheet steel, zinc-plated
- Support rail: Sheet steel, zinc-plated
- Contact hazard protection: Sheet steel, spray-finished

Supply includes:

- Assembly kit
- Support rails
- Contact hazard protection
- Assembly parts



Also required:

- Mounting angles ISV, see page 44

For enclosure width mm	For enclosure height mm	For enclosure depth mm	Width units (WU) @ 250 mm	Height units (U) @ 150 mm	To fit Model No.	Packs of	Model No.
380	600	210	1	3	1008.X00/ 1038.X00	1 pc(s).	9666.801
600	760	210	2	4	1012.X00/ 1076.X00	1 pc(s).	9666.821
1000	1200	300	3	7	1019.X00/ 1213.X00/ 1305.X00	1 pc(s).	9666.851



Mounting angles ISV

for AX

For vertical sub-division of the support frame in the enclosure.

Material:

- Sheet steel

Surface finish:

- Zinc-plated

Height unit		Packs of	Model No.
U	mm		
3	450	2 pc(s).	9666.753
4	600	2 pc(s).	9666.754
6	900	2 pc(s).	9666.756
7	1050	2 pc(s).	9666.757

1 U $\hat{=}$ 150 mm

System accessories AX, KX

Cable gland

Sealing frame, modular

For universal use on all surfaces and walls, for inserting pre-assembled cables with connectors. Can also be mounted onto 24-pole or 16-pole connector cut-outs.

Material:

– Plastic

Colour:

– Black

Protection category IP to IEC 60 529:

– IP 66

Supply includes:

– Sealing frame
– Locking frame

Number of small seal inserts	For cut-out mm	Model No.
10	113.5 x 46 (24-pole)	2583.100
8	91 x 46 (16-pole)	2583.080



Also required:

- Inlay for plastic gland plates, modular and sealing frame, modular, see page 45
- Seal inserts for cable gland plates, modular and sealing frame, modular, see page 45



Inlay

for plastic gland plate, modular and sealing frame, modular

Individual inserts to subdivide the cut-outs in the modular plastic gland plate and the modular sealing frame.

Material:

– Plastic

Colour:

– Black

Design	Packs of	Model No.
1 slot	5 pc(s).	2582.100
2 slots	5 pc(s).	2582.200
4 slots	5 pc(s).	2582.400
6 slots	5 pc(s).	2582.600

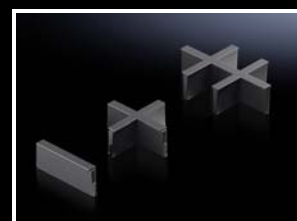

Seal inserts

for plastic gland plate, modular and sealing frame, modular

In conjunction with the inlays, the seal inserts allow individual cable entry, even with preassembled cables.

Material:

– Plastic

Colour:

– RAL 7035



Accessories:

- When using as a gland plate, modular:
Locking clip for seal inserts 2583.120

Seal inserts, small

For cable diameter	Packs of	Model No.
Solid	10 pc(s).	2580.000
3 mm	10 pc(s).	2580.003
4 mm	10 pc(s).	2580.004
5 mm	10 pc(s).	2580.005
6 mm	10 pc(s).	2580.006
7 mm	10 pc(s).	2580.007
8 mm	10 pc(s).	2580.008
9 mm	10 pc(s).	2580.009
10 mm	10 pc(s).	2580.010
11 mm	10 pc(s).	2580.011
12 mm	10 pc(s).	2580.012
13 mm	10 pc(s).	2580.013
14 mm	10 pc(s).	2580.014

Seal inserts, large

For cable diameter	Packs of	Model No.
Solid	5 pc(s).	2580.100
15 mm	5 pc(s).	2580.115
16 mm	5 pc(s).	2580.116
17 mm	5 pc(s).	2580.117
18 mm	5 pc(s).	2580.118
19 mm	5 pc(s).	2580.119
20 mm	5 pc(s).	2580.120
21 mm	5 pc(s).	2580.121
22 mm	5 pc(s).	2580.122
23 mm	5 pc(s).	2580.123
24 mm	5 pc(s).	2580.124
25 mm	5 pc(s).	2580.125



System accessories AX, KX

Connector gland



Connector gland, small

For pre-assembled cables with connectors. For use with material thickness of up to 4 mm. Strain relief of the pre-assembled cables can be achieved with cable ties.

Material:

- Plastic

Colour:

- RAL 9005

Protection category IP to IEC 60 529:

- IP 65 if installed correctly

Supply includes:

- Assembly parts

To fit	Packs of	Model No.
2 cables \varnothing 6 – 8 mm	1 pc(s).	2400.300
3 cables \varnothing 4 – 6 mm	5 pc(s).	2400.500

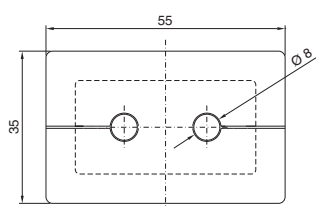

2400.300

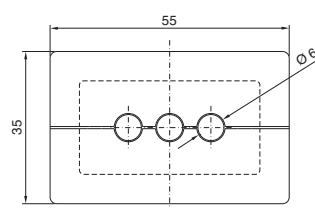

2400.500

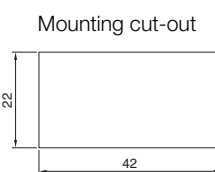
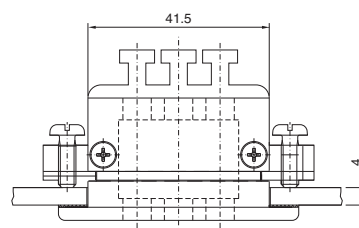
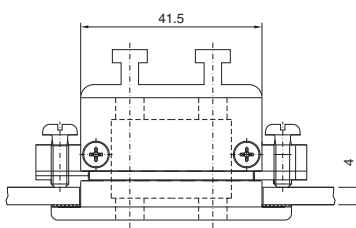
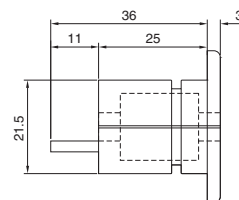

Mounting cut-out

System accessories AX, KX

Cable glands

Cable gland, brass

Benefits:

- Because the gland and lock nut are sold together in a single pack, this saves additional ordering and storage
- Clamping membranes for even tightening and strain relief to protect the cables

Material:

- Brass
- Seal: CR/NBR

Surface finish:

- Nickel-plated

Protection category IP to IEC 60 529:

- IP 68 (5 bar, 30 min.)

Approvals:

- VDE, UR, cUR

Size	Packs of	Model No.
M12 x 1.5	15 pc(s).	2411.801
M16 x 1.5	15 pc(s).	2411.811
M20 x 1.5	10 pc(s).	2411.821
M25 x 1.5	10 pc(s).	2411.831
M32 x 1.5	5 pc(s).	2411.841
M40 x 1.5	4 pc(s).	2411.851
M50 x 1.5	2 pc(s).	2411.861
M63 x 1.5	1 pc(s).	2411.871



Cable gland, polyamide

Benefits:

- Because the gland and lock nut are sold together in a single pack, this saves additional ordering and storage
- Clamping membranes for even tightening and strain relief to protect the cables

Material:

- Polyamide 6
- Seal: CR/NBR

Colour:

- RAL 7035

Protection category IP to IEC 60 529:

- IP 68 (5 bar, 30 min.)

Approvals:

- VDE, UL, cUL, CSA, CSAUs

Size	Packs of	Model No.
M12 x 1.5	50 pc(s).	2411.601
M16 x 1.5	50 pc(s).	2411.611
M20 x 1.5	50 pc(s).	2411.621
M25 x 1.5	25 pc(s).	2411.631
M32 x 1.5	15 pc(s).	2411.641
M40 x 1.5	5 pc(s).	2411.651
M50 x 1.5	5 pc(s).	2411.661
M63 x 1.5	3 pc(s).	2411.671



EMC cable gland

The cable sheathing may optionally be interrupted at the contact point or removed completely inside the enclosure. The cable shielding in the enclosure is retained. The supplied lock nut cuts automatically into the paint when screwed onto spray-finished enclosure surfaces, thus creating a conductive connection.

Protection category IP to IEC 60 529:

- IP 68

Material:

- Brass
- Seal: CR/NBR

Surface finish:

- Nickel-plated

Approvals:

- VDE, UR, cUR

Cable glands, metric

Size	Cable diameter mm	Minimum shield diameter ¹⁾ mm	Packs of	Model No.
M16	4.5 – 10	3	5 pc(s).	2843.160
M20	6 – 12	5	5 pc(s).	2843.200
M25	11 – 17	8	5 pc(s).	2843.250
M32	15 – 21	10	1 pc(s).	2843.320
M40	19 – 28	15	1 pc(s).	2843.400
M50	27 – 38	19	1 pc(s).	2843.500
M63	34 – 44	30	1 pc(s).	2843.630

¹⁾ Minimum shield diameter = cable diameter minus cable sheathing



LED system light

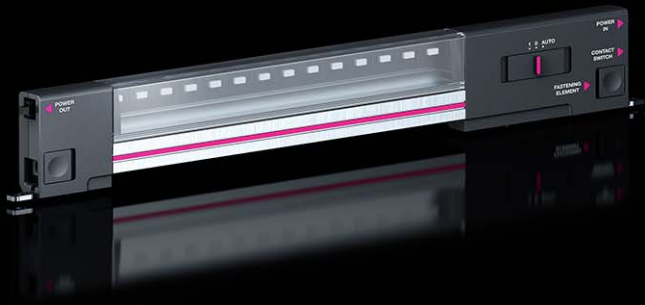

Compact enclosures AX Page 11 **Connection accessories** Page 49

Benefits:

- Optimum illumination of the entire enclosure
- Optionally with clip, screw or magnetic attachment
- Equipment to suit every application

Material:

- Plastic
- Aluminium

Colour:

- Enclosure: RAL 7016

Light colour:





- 4000 K (neutral white)

Supply includes:

- Assembly screws

Note:

- The internal mounting rail AX and the mounting bracket are required when installing in compact enclosures AX, see table
- Connection accessories should be ordered separately
- Further information on country-specific versions can be found on the Internet
- Other system lights, e.g. with a higher luminosity and with motion detector can be found on the Internet

					
Model No.		2500.114	2500.110	2500.104	2500.100
Output (lumens)		600	600	400	400
Length (mm)		337	337	262	262
Rated operating voltage	100 – 240 V AC	■	■	■	■
Protection class		II (all-insulated)			
Approvals	UL	■	–	■	–
	cUL	■	–	■	–
	CCC	■	■	■	■
	ENEC	■	■	■	■
Installation type	Screw-fastening	■	■	■	■
	Clip attachment	■	■	■	■
	Magnetic attachment to surfaces (accessory)	■	■	■	■
Connection options	Infeed	2-pole	2-pole	2-pole	2-pole
	Through-wiring	2-pole	2-pole	2-pole	2-pole
	Door-operated switch (accessory)	■	■	■	■
Accessories					
Rail for interior installation AX		see page 77			
Mounting bracket		6205.100	6205.100	6205.100	6205.100
Mounting kit magnet		2500.490	2500.490	2500.490	2500.490
Door-operated switch		–	2500.460	–	2500.460
Door-operated switch, UL		2500.470	–	2500.470	–
Also required: Connection accessories depending on application type					
Infeed, 2-pole		–	2500.420	–	2500.420
Infeed, 2-pole, UL		2500.520	–	2500.520	–
Through-wiring, 2-pole		–	2500.450	–	2500.450
Through-wiring, 2-pole, UL		2500.550	–	2500.550	–

LED system light

Accessories

Connection accessories

for LED system light

The following components can be used for time-saving, easy installation of the lights:

+ Accessories:

- Cable ties 2597.000

Connection cable for	UL	Length mm	Packs of	Model No. orange
[1] Infeed, 2-pole, 100 – 240 V AC	■	3000	1 pc(s).	2500.520
[1] Infeed, 2-pole, 100 – 240 V AC	-	3000	5 pc(s).	2500.420
[2] Through-wiring, 2-pole, 100 – 240 V AC	■	1000	1 pc(s).	2500.550
[2] Through-wiring, 2-pole, 100 – 240 V AC	-	1000	5 pc(s).	2500.450

- A** Connection cable for infeed
- B** Connection cable for through-wiring
- C** Door-operated switch with connection cable (not required for LED system light with integral motion sensor)

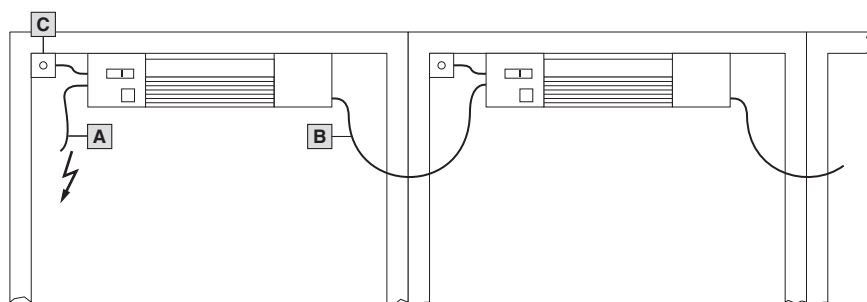

Door-operated switch

with connection cable for LED system light

Supply includes:

- Assembly parts

	ENEC	UL	Length mm	To fit	Packs of	Model No. black
Connection cable	■	-	800	230 V AC/24 V DC, 1 A	1 pc(s).	2500.460
	-	■	800		1 pc(s).	2500.470



Technical information

Outdoor use of enclosures

In order to guarantee satisfactory long-term function of enclosures in outdoor use, the relevant environmental factors must be taken into account.

These include:

- UV radiation, the corrosive action of air pollution, rain, icing, snow, wind or other factors in special climatic conditions.

Condensation inside the enclosure

Condensation must be prevented by means of appropriate measures, e.g. by venting or heating the enclosure.

Protection category

The enclosure may be exposed to extreme weather conditions during outdoor use.

Long periods of rain, snow, ice, high winds and temperature fluctuations place particularly high demands on the enclosure sealing. The protection category IP X3 as envisaged for external weather conditions in DIN VDE 0100, part 737, point 5.2 is often insufficient to provide permanent protection for electrical equipment.

Suitable applications for each enclosure type are described in the relevant instructions.

Protection categories to IEC 60 529 (EN 60 529)

The IP protection category is characterised by 2 numerals.

Example of a protection category, e.g. IP 43:

Code letters	
IP	
First numeral	Second numeral
4	3

Degrees of protection for protection against contact and foreign bodies: First numeral			Degrees of protection for protection against water: Second numeral		
First numeral	Degree of protection Designation	Explanation	Second numeral	Degree of protection Designation	Explanation
1	Protected against solid foreign objects with a diameter of 50 mm and greater	The object probe, a sphere 50 mm in diameter, must not penetrate fully. ¹⁾	1	Protected against vertically falling water drops	Vertically falling drops shall have no harmful effects.
2	Protected against solid foreign objects with a diameter of 12.5 mm and greater	The object probe, a sphere 12.5 mm in diameter, must not penetrate fully. ¹⁾ The articulated test finger may penetrate up to its length of 80 mm, but adequate distance from hazardous parts must be adhered to.	2	Protected against vertically falling water drops when the enclosure is tilted up to 15°	Vertically falling drops shall not have any harmful effects when the enclosure is tilted up to 15° on either side of the vertical.
3	Protected against solid foreign objects with a diameter of 2.5 mm and greater	The object probe, a sphere 2.5 mm in diameter, must not penetrate at all ¹⁾ .	3	Protected against sprayed water	Water sprayed at an angle of up to 60° on either side of the vertical shall have no harmful effects.
4	Protected against solid foreign objects with a diameter of 1.0 mm and greater	The object probe, a sphere 1.0 mm in diameter, must not penetrate at all ¹⁾ .	4	Protected against splashed water	Water splashed on the enclosure from any direction shall have no harmful effects.
5	Dust-protected	The ingress of dust is not fully prevented, but dust shall not enter to such an extent as to impair satisfactory operation of the device or safety.	5	Protected against water jets	Water directed at the enclosure from any direction in a jet shall have no harmful effects.
6	Dust-tight	No ingress of dust at a partial vacuum of 20 mbar inside the enclosure.	6	Protected against powerful water jets	Water directed at the enclosure from every direction in a powerful jet shall have no harmful effects.
			7	Protected against temporary immersion in water	Water must not ingress to such an extent as to cause harmful effects when the enclosure is temporarily immersed in water under standardised pressure and time conditions.
			8	Protected against continuous immersion in water	Ingress of water in quantities causing harmful effects shall not be possible when the enclosure is continuously immersed in water under conditions to be agreed between the manufacturer and the user. However, the conditions must be more difficult than for numeral 7.
			9	Protected against high-pressure and high-temperature water jets	Water projected at high pressure and high temperature against the enclosure from any direction shall not have harmful effects.

¹⁾ The full diameter of the object probe must not pass through an opening of the enclosure.

NEMA

The **N**ational **E**lectrical **M**anufacturers **A**ssociation (NEMA) is a standards organisation in Washington, USA, which publishes a number of technical standards but does not test or certify products itself.

The following NEMA classification outlines the protection of individuals from accidental contact with equipment and the protection of an enclosure from external factors.

Further information on protection categories may be found on the Internet at: www.rittal.com

UL/NEMA Type	Intended use and description
1	Enclosures for use predominantly indoors Protection against the penetration of foreign bodies
3	Enclosures for use predominantly outdoors Protection from rain, hail, dust, icing and the damage caused by icing
3R	Enclosures for use predominantly outdoors Protection from rain, hail, icing and the damage caused by icing
3S	Enclosures for use predominantly outdoors Protection from rain, hail and dust External mechanisms remain usable despite being coated in ice
4	Enclosures for indoor or outdoor use Protection against rain, foreign bodies, splashed water and hosed water and against damage caused by icing on the exterior of the enclosure
4X	Enclosures for indoor or outdoor use Protection against rain, foreign bodies, splashed water and hosed water and against damage caused by icing on the exterior of the enclosure Increased protection from corrosion
12, 12K	Enclosures for use predominantly indoors Protection against dust deposits, foreign bodies and non-corrosive dripping liquids
13	Enclosures for use predominantly indoors Protection against dust deposits, sprayed water, oil, and non-corrosive refrigerants

The UL/NEMA classifications are not directly comparable with IP protection categories, since both the test conditions and the evaluation of the test results are different

Approvals and permits

Product certifications and approvals are pivotal to the global acceptance of industrial products.

Rittal products meet the highest internationally recognised quality yardsticks. All components are subjected to the most stringent testing in accordance with international standards and regulations.

The consistently high product quality is ensured by a comprehensive quality management system. Regular production inspections by external test institutes also guarantee compliance with global standards

A precise allocation of products to marks of conformity can be found on our product and service pages on the Internet at www.rittal.com

PE conductor connection

The PE conductor connection must be designed by the manufacturer of switchgear in accordance with the relevant VDE and/or local regulations.

The enclosure packs generally contain earthing materials (screws, nuts, washers). The assembly instructions contain recommendations on installing a PE conductor.

The pre-assembled earth straps, available as accessories in various cross-sections and lengths, are intended to make assembly of a PE conductor easier.

Further information can be found in our technical documentation "PE conductor connection, current carrying capacity".

Suitable applications for each enclosure type are described in the relevant instructions.

Rittal – The System.

Faster – better – everywhere.

- Enclosures
- Power Distribution
- Climate Control
- IT Infrastructure
- Software & Services

You can find the contact details of all Rittal companies throughout the world here.



www.rittal.com/contact

XWWW00269EN2408

ENCLOSURES

POWER DISTRIBUTION

CLIMATE CONTROL

IT INFRASTRUCTURE

SOFTWARE & SERVICES



FRIEDHELM LOH GROUP