

Rittal – The System.

Faster – better – everywhere.



TS8 Disconnect Enclosure

9951.130	9951.131	9951.134
9951.135	9951.136	9951.142
9951.143	9951.144	9951.145
9951.146	9951.153	9951.154
9951.137	9951.138	9951.140
9951.147	9951.148	9951.150
9951.151		

Supplementary information to the assembly instructions for TS8 FMD enclosures

ENCLOSURES

POWER DISTRIBUTION

CLIMATE CONTROL

IT INFRASTRUCTURE

SOFTWARE & SERVICES

FRIEDHELM LOH GROUP



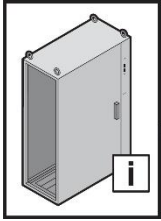

Contents

1. Notes on documentation	3
2. Safety instructions	4
3. Scope of delivery	6
4. Required tools	7
5. Enclosure Component Overview	8
6. Installation of disconnect handle	9
7. Installation of connection rod	13
8. Adjusting the door catch	15/16
9. Testing and troubleshooting	17
Step 1: Test the handle-lockrod engagement (Door open)	17
Step 2: Test the handle-lockrod engagement (Door closed).....	18
Step 3: Test the door lockout engagement.....	19
10. Assembly of eyebolts	20
11. Notes	Fehler! Textmarke nicht definiert.

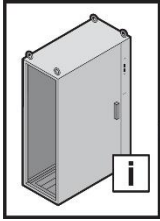

1. Notes on documentation

The assembly instructions are aimed at all persons who have an appropriate specialist training to allow them to equip enclosures to conform to standards with electrical, electronic, mechanical or pneumatic operating equipment, to place or install at the destination site and to connect ready to operate.

1.1 Disclaimer

Rittal Corporation accepts no liability for any damage resulting from a failure to comply with these instructions. Rittal Corporation reserves the right to further developments and technical modifications of its products.

Such modifications, along with errors and printing errata, shall not constitute grounds for compensation. Reference is made to the Terms of Sale and Delivery.

1.2 Storing documentation

These instructions constitute an integral part of the product. They must be given to the plant operator, who is responsible for keeping them in a safe place so they are readily available when needed.

1.3 Other applicable documents

The instructions for the TS8 enclosures and any accessories used also apply.

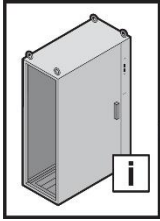







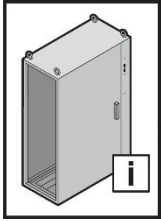

2. Safety instructions

Observe the following general safety instructions during assembly and operation of the distribution cabinet:

- Work on electrical systems may only be carried out by a qualified electrician or by instructed personnel under the direction and supervision of a qualified electrician!
- Please do not make any changes to this product that are not described in these installation and operating instructions.
- The operational safety of the product is only guaranteed under intended use.
- Technical limits must never be exceeded. Operation is only permitted within the specified performance limits.
- When closing the door, make sure that nothing gets trapped.
- Make sure that no one is obstructed by an open door.
- Make sure that the enclosure does not protrude into an escape route when installed.
- Enclosures that are damaged must be disconnected from the circuit immediately and must not be used anymore.



2. Safety instructions

	Warning against closing movements for mechanical parts of a machine/device
	Risk of tipping due to displacement of center of gravity
	Caution: Heavy loads
	Caution: Obstructions in head area
	Caution: Dangerous electrical voltage
	The instruction must be read
	Personal protective equipment
	Installation by specialist mechanics
	Installation by specialist electricians

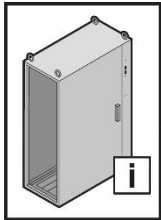

3. Scope of delivery







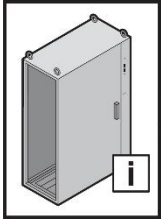

	Bolt	M4x12	2 x
	Nut	M4	3 x
	Screw	5.5 x 13	2 x
	Collet	M5	2 x
	Allen Key	1.5 mm	1 x
	Universal Defeater Lever		1 x
	Eaton Flex Shaft Defeater Lever		1 x
	LSIS defeater Lever		1 x
	Adapter Bracket Siemens		1 x
	Connecting Rod		1 x
	Siemens door catch		1 x

Please check the delivery is complete and undamaged. Any obvious transport damage must be reported to the responsible transport company without undue delay.

Check packaging material for any loose parts prior to disposal!



4. Required tools

	 TX25
	 PH2
	 AF 7 mm AF 0,28"
 <p>(In the accessory pack of the enclosure available)</p>	 AF 1.5 mm AF 0.06"

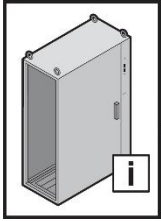

5. Enclosure Component Overview

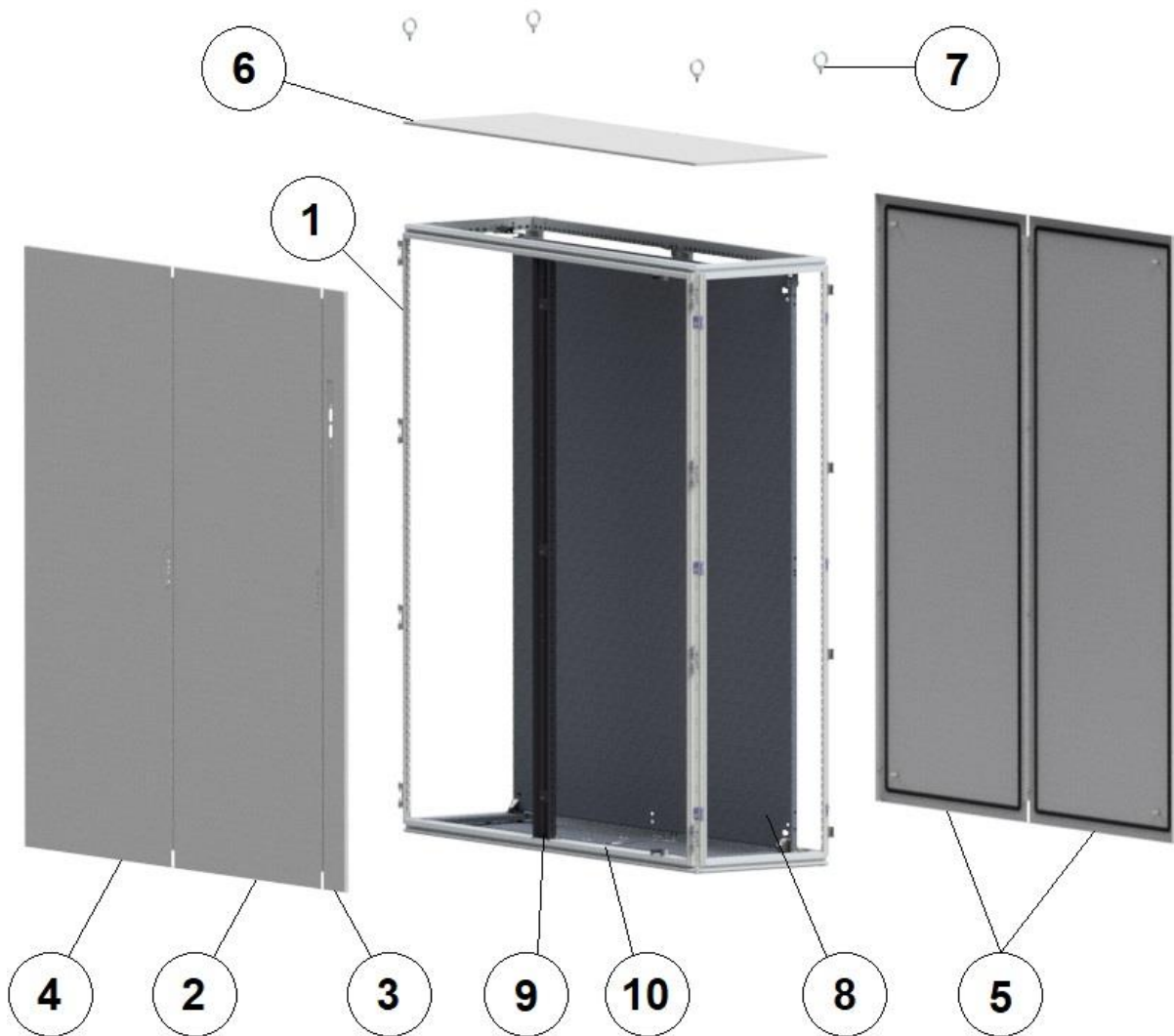

① TS Frame

② Master Door

③ FMDC Door

④ Slave Door

⑤ Twin Rear Walls

⑥ Roof

⑦ 4 x Eyebolts

⑧ Mounting Panel

⑨ Front Mullion

⑩ Base Frame With Cable Plates

Note:

- Three door enclosure shown. Items ④ and ⑨ not included with two door enclosures
- Twin rear walls used in enclosure wider than 1,000 mm / 39 inches

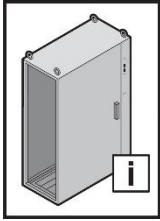

6. Installation of disconnect handle

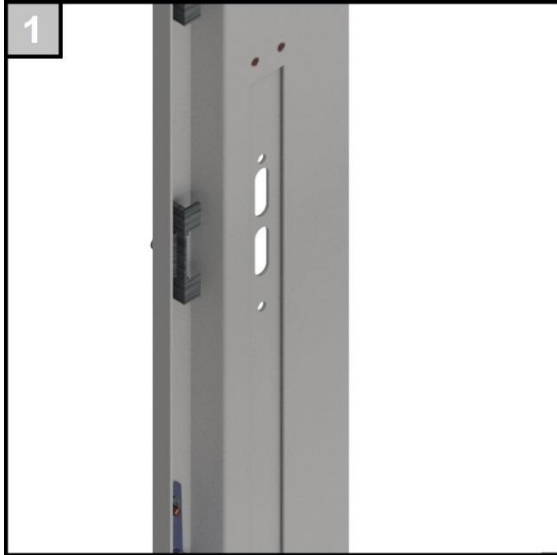

The suitable adapter plate must be selected and installed (adapter plate 9951.157 is already included and installed in the scope of delivery of the enclosure).

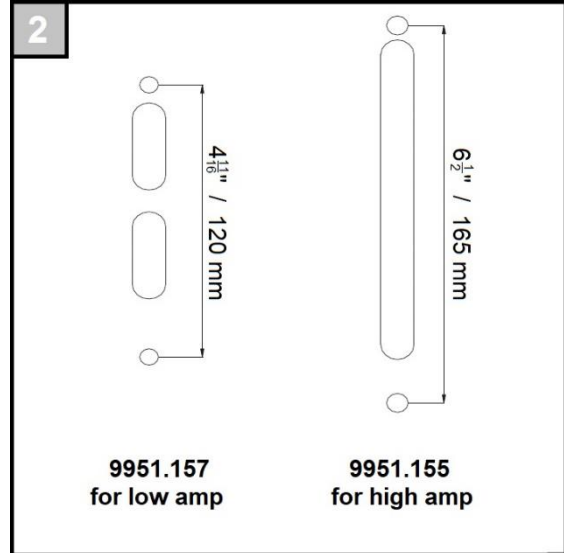

Adapter plate 9951.157 with universal cutout for low amp disconnects-standard or adapter plate 9951.155 with universal cutout for high amp disconnects-standard.

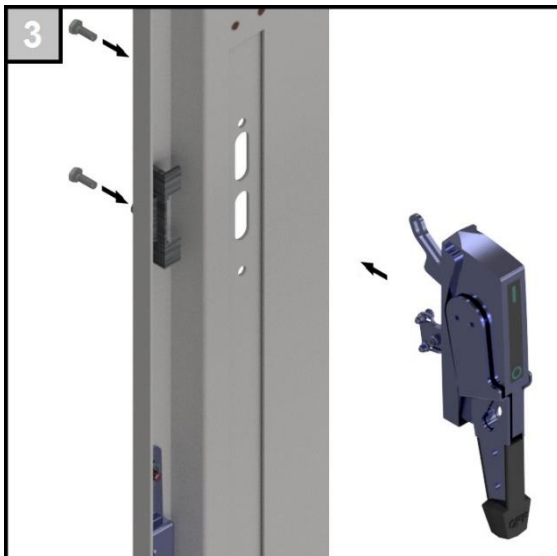

The disconnect handle (not supplied with the enclosure) is mounted according to the manufacturer's specifications. For Attachment use manufacturer's hardware.

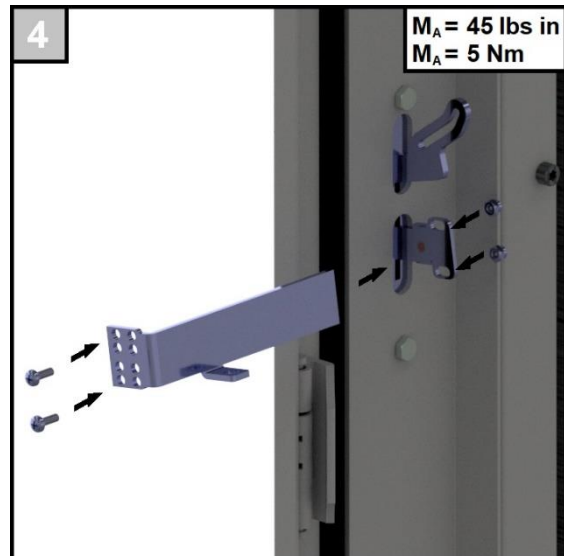

The defeater lever is attached to the disconnect handle as described on the following pages. If the handle has threaded holes, use manufacturer's hardware. If the handle has thru-holes, use Rittal M4x12 screws and M4 nuts.

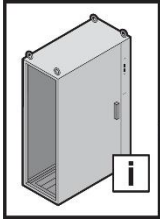

6. Installation of disconnect handle

For correct assembly of the defeater lever, the appropriate configuration option must be found in the table below (for assembly instructions, see next page).

Low amp (cutout 4 11/16")		
Manufacturer	Handle / Operator	Configuration Option
Rockwell / Allen Bradley	140G M1/S1/P1/P2	1*
	1494C (≤ 200 A)	1*
	1494F M1/S1/P1	1*
	1494V (≤ 200 A)	1*
	194R	1*
ABB	DSFHN-HS	3*
	OHF1C	2
Eaton	C361	3*
	C371	3*
	Flex Shaft CH	Special defeater lever
GE	SCH1 / SCH2	3
	SCOM	3
	SDOM	3
	STDA	3
	TDOM	3
Siemens	FDH10 / FDH20	2
	FHOH	2
	MFHM3RS / MFHM4X	4
	3VA9977-0CH72	4
	3VA9278-0DK84	4
Square D	9422 Type A1/A3/A9	3
	9422 Type A2 / A4 / A10	3
LSIS	Various	Special defeater lever

* = use hardware supplied by disconnect handle manufacturer

High amp (cutout 6 1/2")		
Manufacturer	Handle / Operator	Configuration Option
Rockwell / Allen Bradley	1494C (400 – 600 A)	1
	1494F M2 / S2	1
	1494V (400 – 600 A)	1
ABB	K7FCH	2
Siemens	FHOHN	2
	MFHP3R / MFHP4X	4
	VBH2	2
LSIS	Various	Special defeater lever

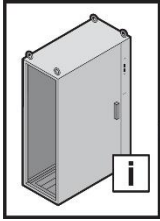

6. Installation of disconnect handle

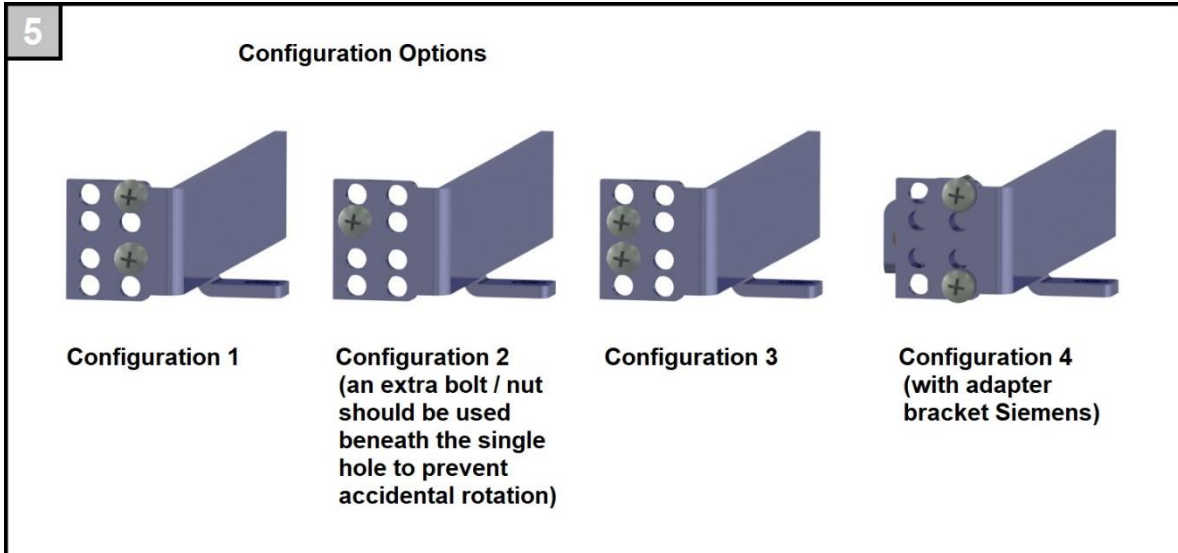

Caution! If the mounting holes shown here are not used when mounting the defeater lever on the disconnect handle, the system will not function properly!

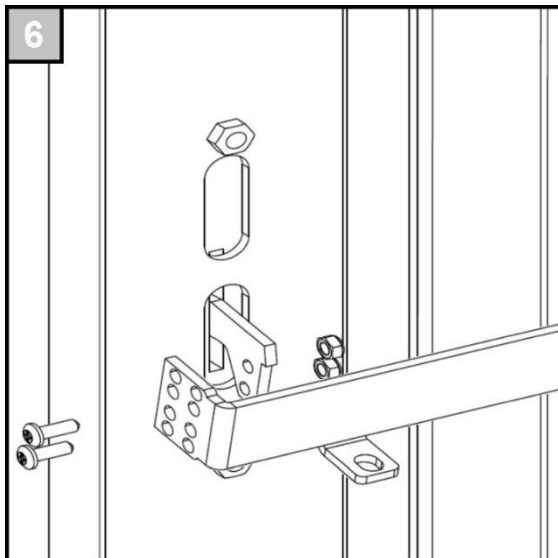

It must be ensured that the defeater lever and the screws are attached to the disconnect tab from the left.

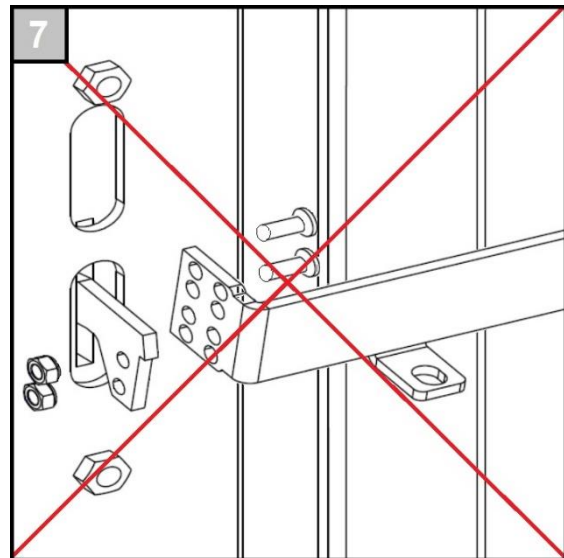

The assembly of the defeater lever and the screws from the right is not permitted!

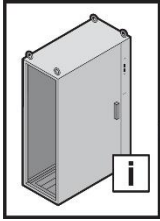

6. Installation of disconnect handle

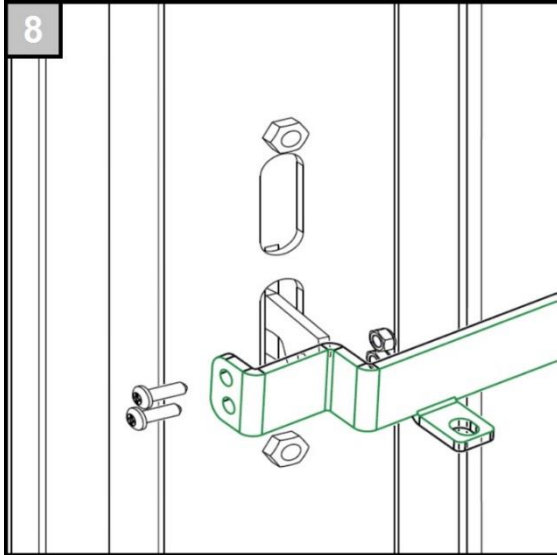

The special deflector levers for switches from Eaton and LSIS must also be installed from the left.

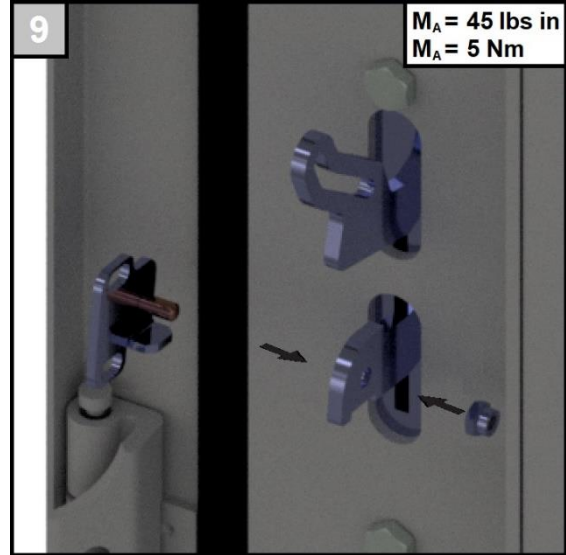

Only for configuration option 4: the adapter bracket Siemens is first mounted on the disconnect handle.

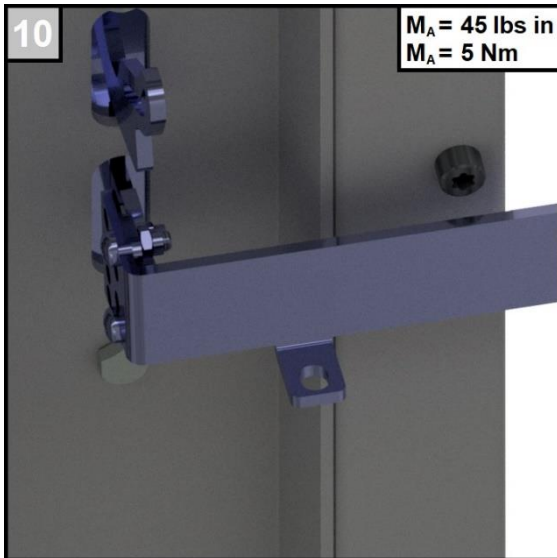

Only for configuration option 4: then the deflector lever can be attached to the adapter bracket Siemens. The mounting holes must be selected as shown in Figure 5!

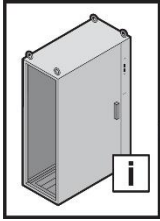

7. Installation of connection rod

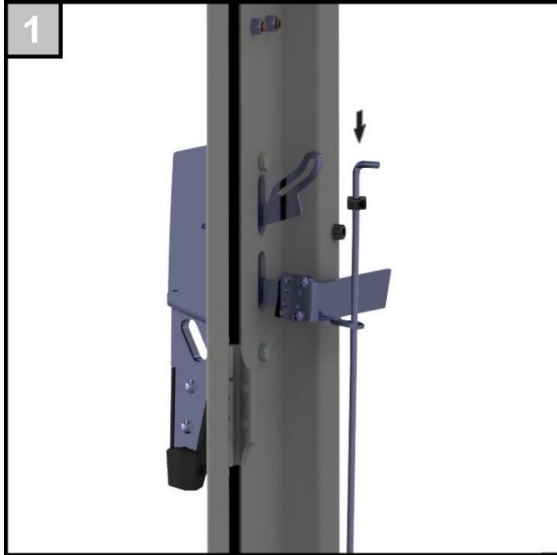

The connecting rod must be pushed from above through the first collet and the hole in the tab of the defeater lever.

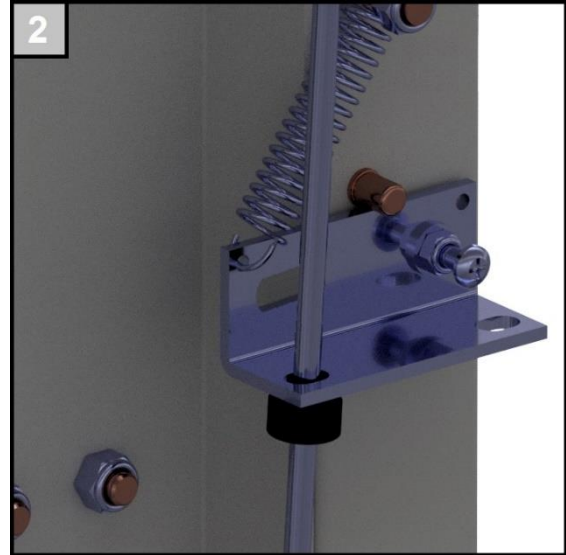

Then the connecting rod must be pushed through the activator bracket and then through the second collet.

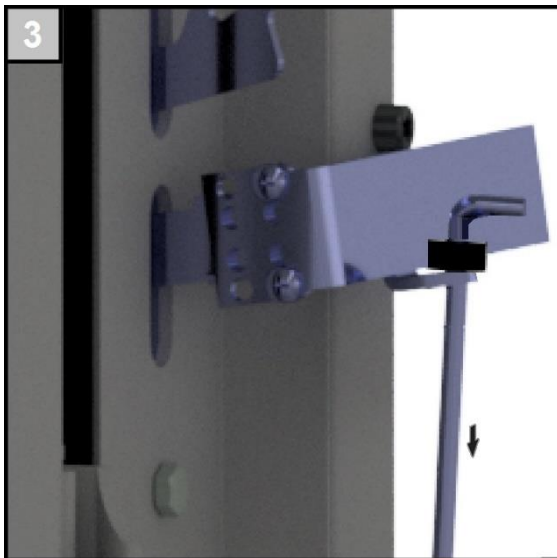

The connecting rod must be pushed down as far as possible.

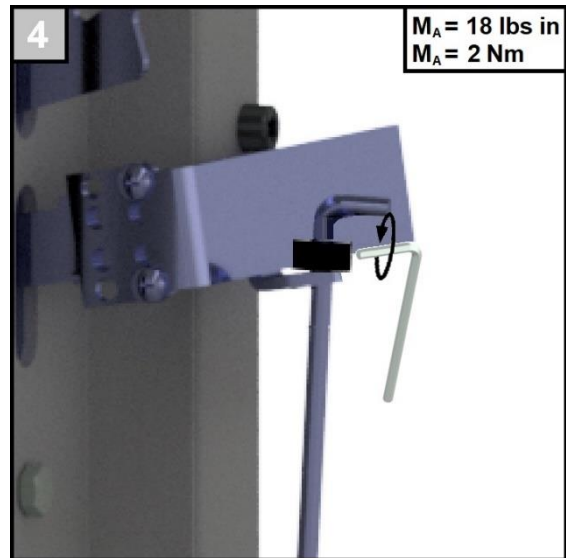

The upper collet is fixed with the supplied 1.5 mm Allen key.

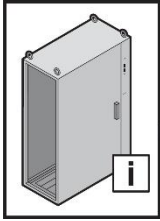

7. Installation of connection rod

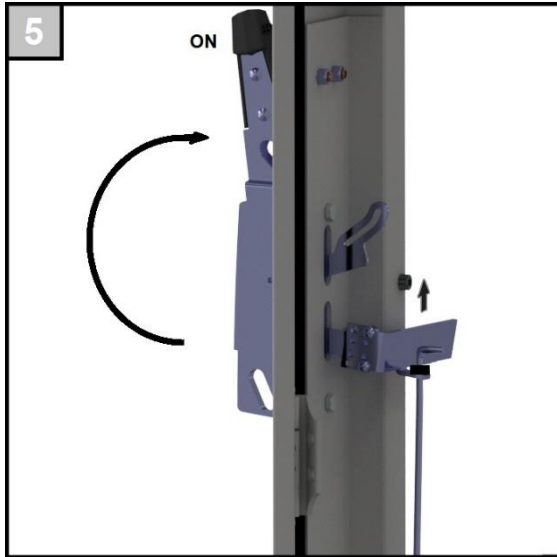

Turn the disconnect handle to the 'ON' position by pushing down on the defater lever.

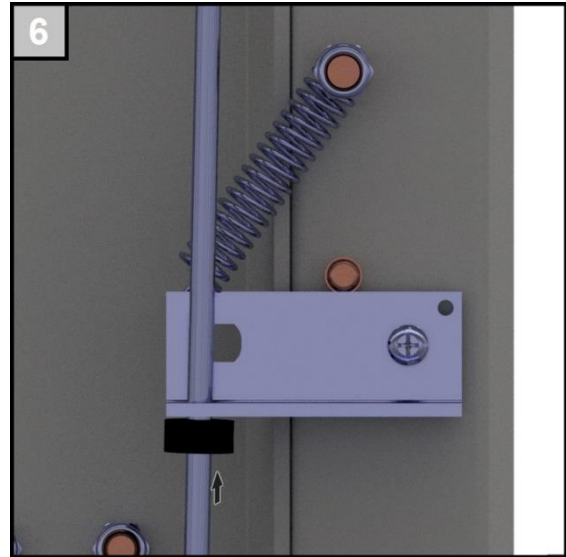

Position the lower collet just below the activator bracket.

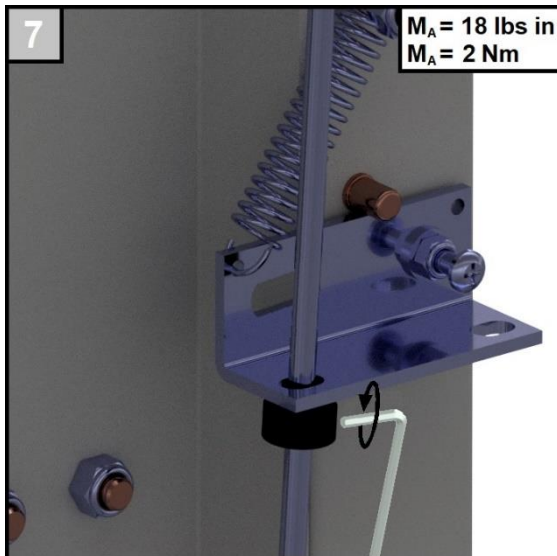

The lower collet is fixed with the supplied 1.5 mm Allen key.

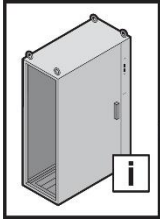

8. Adjusting the door catch

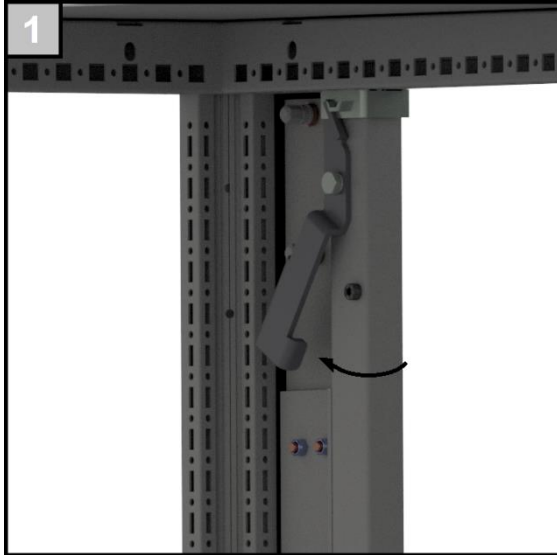

The FMDC door must be closed and fully latched at the top and bottom. The screws of the door catch need to be loosened a little.



The door catch is adjusted through the side opening of the enclosure. A side wall must not be installed at this point. The master door should be closed but NOT latched.



When the disconnect handle is switched 'ON', the door catch is positioned and tightened on the master door stiffener above the defeater lever so that the master door is effectively locked and opening is prevented.

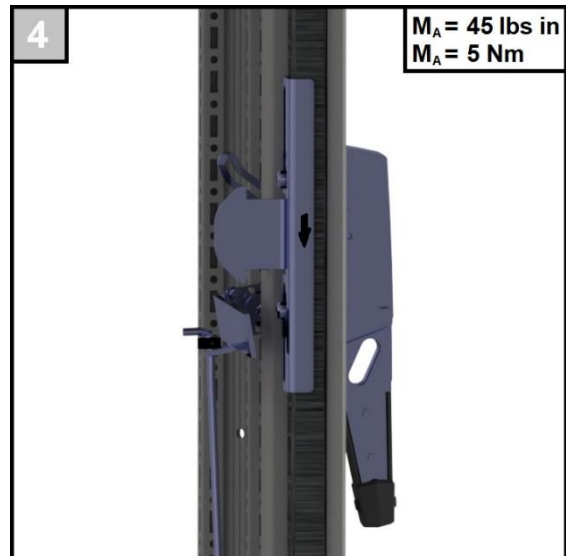

When the disconnect handle is switched to "OFF", the defeater lever is lowered so far that it is no longer blocked by the door catch. The door can be opened. Then the screws of the door catch must be tightened.

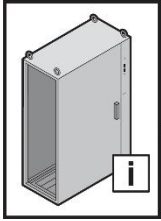

8. Adjusting the door catch

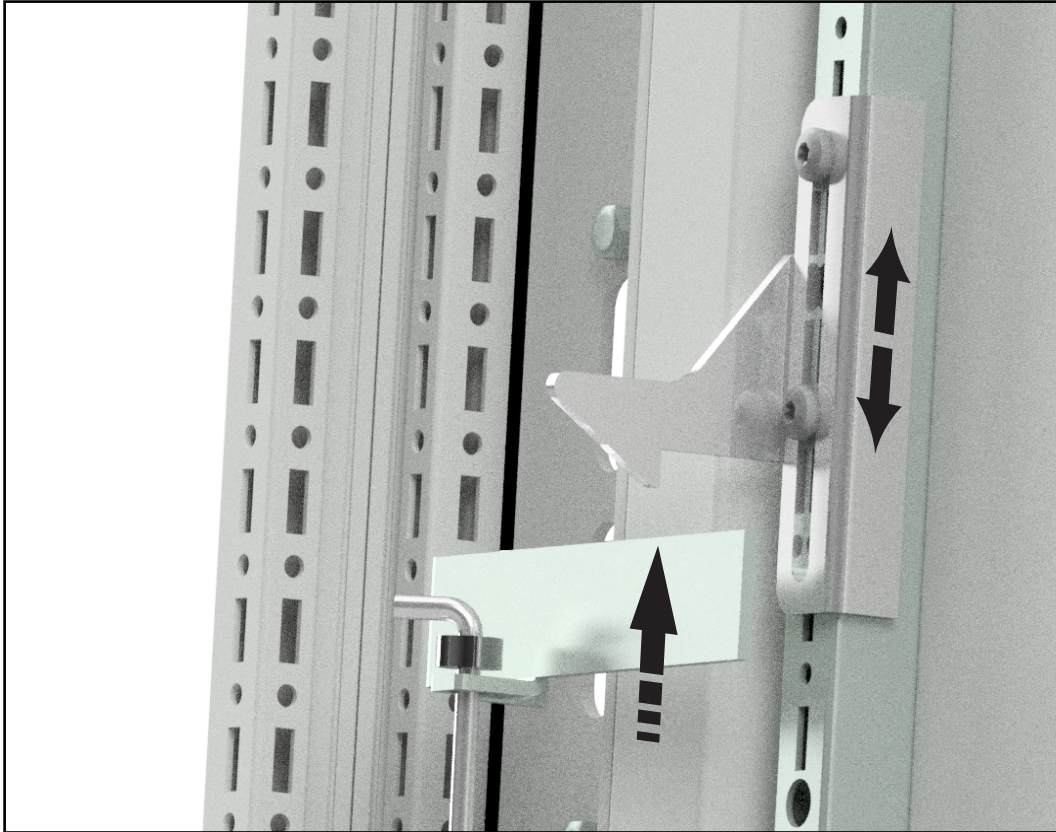

Note:

For uses with Siemens handles:

Model: 3VA9977-0CH72

Model: 3VA9278-0DK84

** Should only be used with handle listed above **

Standard location adjustment will apply, See page 15 in this manual.

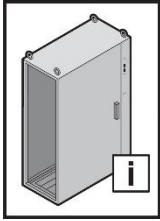

9. Testing and troubleshooting

Step 1: Test the handle-lockrod engagement (Door open)

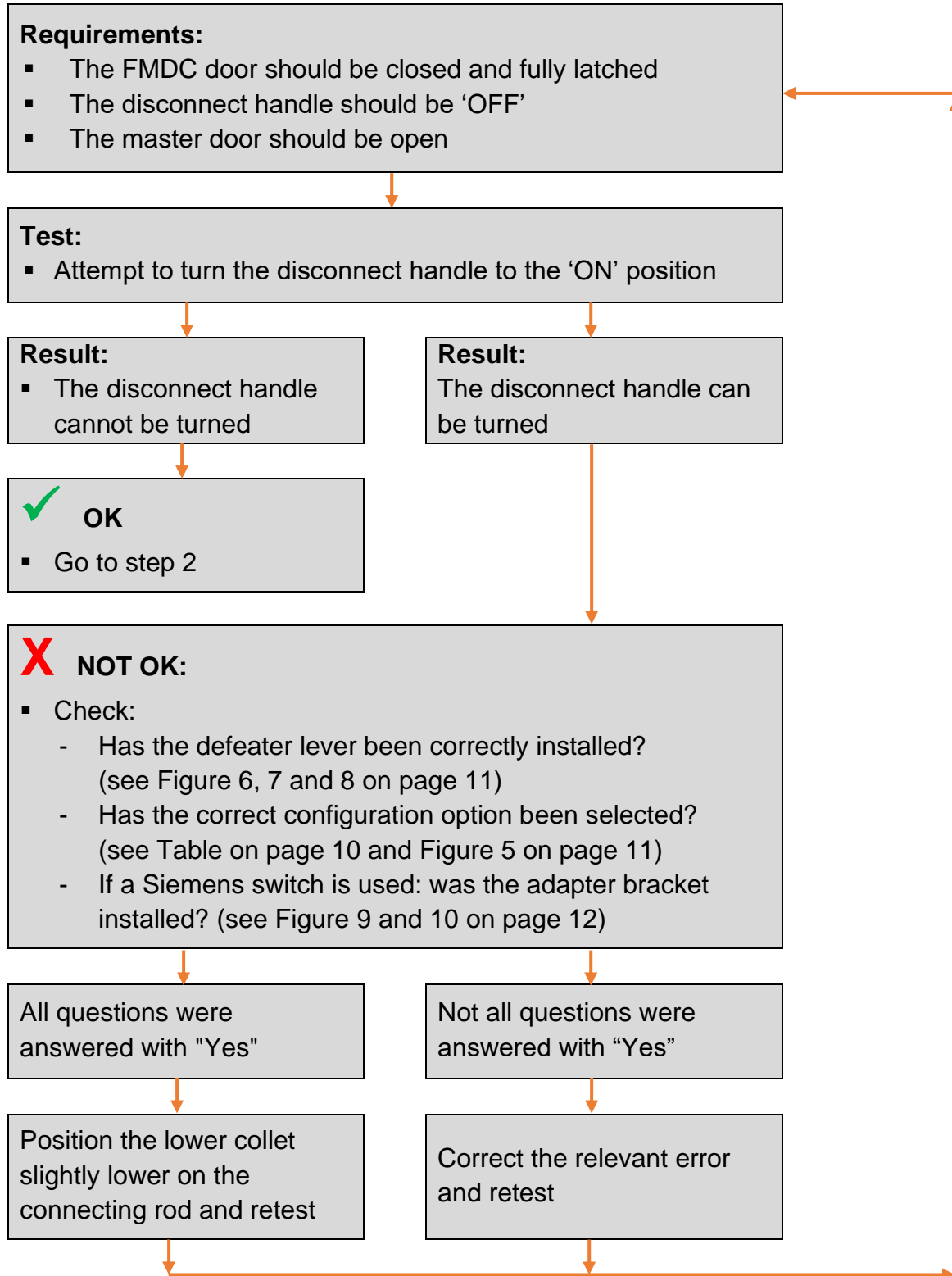

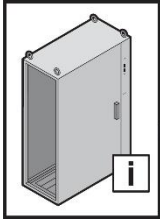

9. Testing and troubleshooting

Step 2: Test the handle-lockrod engagement (Door closed)

Requirements:

- The FMDC door should be closed and fully latched
- The disconnect handle should be 'OFF'
- The master door should be closed and fully latched

Test:

- Attempt to turn the disconnect handle to the 'ON' position

Result:

- The disconnect handle can be turned

✓ **OK**

- Go to step 3

Result:

The disconnect handle cannot be turned

X NOT OK:

- Check:
 - Has the defeater lever been correctly installed? (see Figure 6, 7 and 8 on page 11)
 - Has the correct configuration option been selected? (see Table on page 10 and Figure 5 on page 11)
 - If a Siemens switch is used: was the adapter bracket installed? (see Figure 9 and 10 on page 12)

All questions were answered with "Yes"

Position the lower collet slightly higher on the connecting rod and retest

Not all questions were answered with "Yes"

Correct the relevant error and retest

Go back to step 1

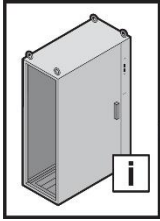

9. Testing and troubleshooting

Step 3: Test the door lockout engagement

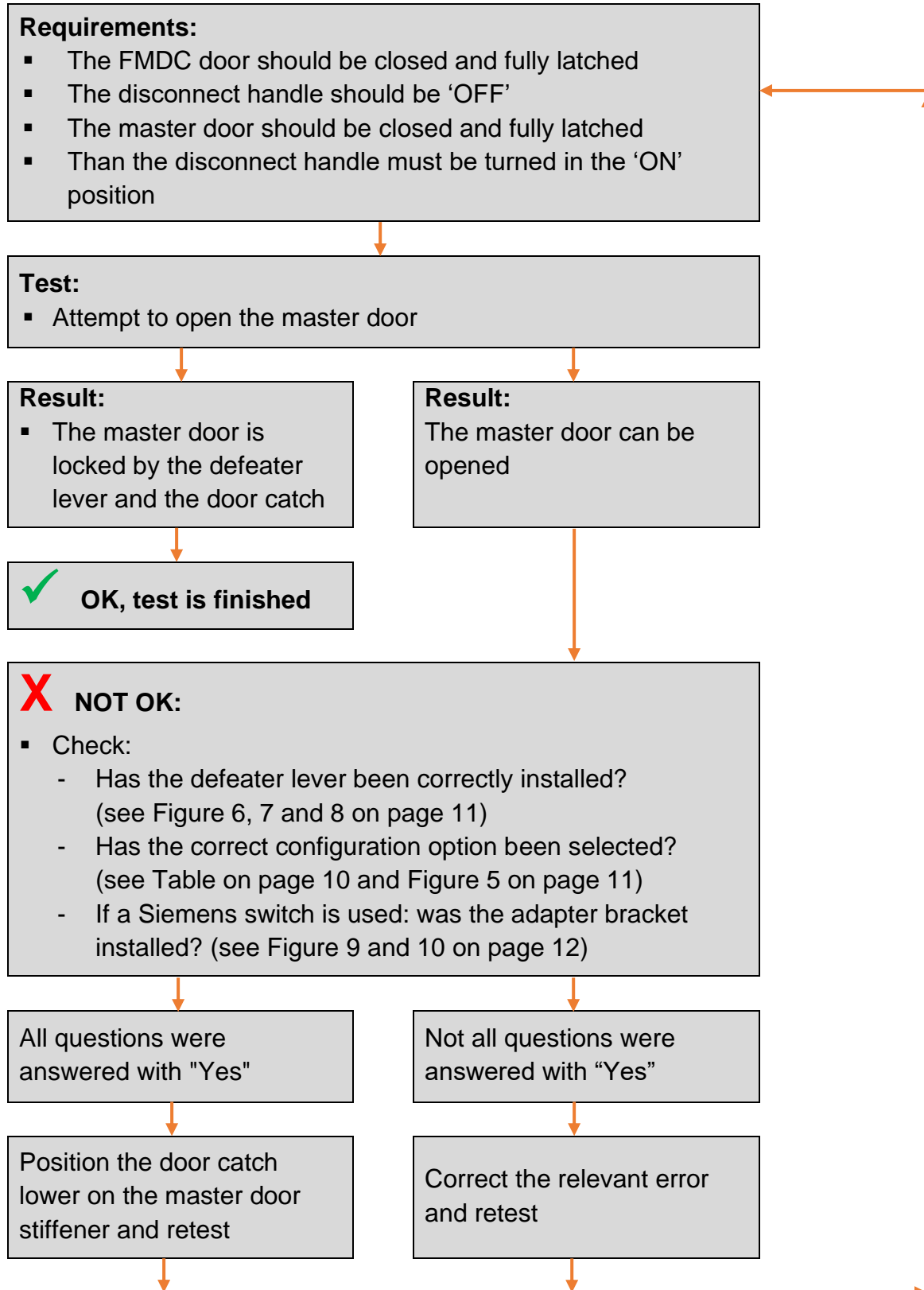

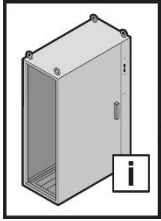

10. Assembly of eyebolts

In addition to the assembly instructions for TS8 enclosures, the information on torque must be observed when assembling eyebolts!



Ensure the rubber washer is set over each of the 4 eyebolts.

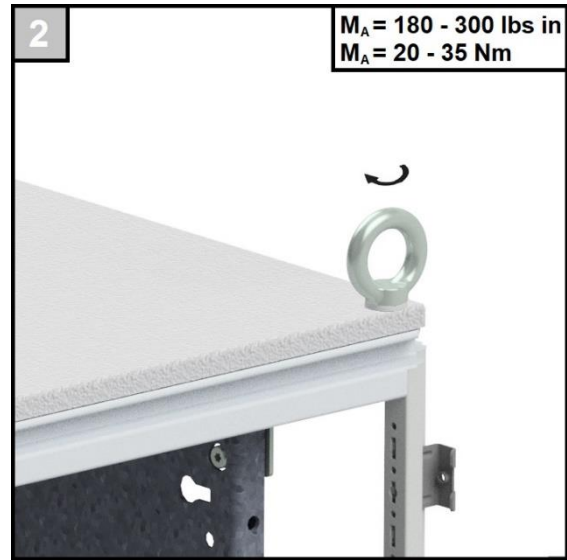

Rotate each of the 4 eyebolts so that they are parallel with the left and right sides of the enclosure.

Note:

- Only tighten the eyebolts, never loosen them to align them!

\angle	90°	45°	60°	
F	13,600 N	4,800 N	6,400 N	Max. 14,000N

Rittal – The System.

Faster – better – everywhere.

- Enclosures
- Power Distribution
- Climate Control
- IT Infrastructure
- Software & Services

You can find the contact details of all Rittal companies throughout the world here.



www.rittal.com/contact

Rittal North America LLC

Woodfield Corporate Center
425 North Martingale Road, Suite 400 + Schaumburg, Illinois 60173 + USA
Phone: (+1) 937-399-0500 + Toll-free: 800-477-4000
E-Mail: rittal@rittal.us + Online: www.rittal.us

Rittal Systems Ltd.

6485 Ordan Drive + Mississauga, Ontario L5T 1X2 + Canada
Phone: (+1) 905-795-0777 + Toll-free: 800-399-0748
E-Mail: marketing@rittal.ca + Online: www.rittal.ca

Rittal, S.A. de C.V.

Boulevard Alberto Einstein S/N + 50160 Toluca de Lerdo + Mexco, D.F.
Phone (+52) (55) 5559-5369 + Toll-Free: 01 800 8 Rittal (748.825)
E-Mail: info@rittal.com.mx + Online: www.rittal.com.mx

08.21/D-0000-TD-P-REV00

ENCLOSURES

POWER DISTRIBUTION

CLIMATE CONTROL

IT INFRASTRUCTURE

SOFTWARE & SERVICES

